

2026

PRODUCT CATALOG

**ADVERTISING MEDIA AND DISPLAY SYSTEMS
FOR PRINTING HOUSES AND ADVERTISING AGENCIES**



ABOUT US / QUIÉNES SOMOS / A PROPOS DE NOUS

 We are one of the largest manufacturer and distributor of advertising media and display systems in Europe. Our offer includes a.o.: roll-ups, ad. walls, flag poles, wooden products, tent frames and much more.

 Somos uno de los mayores fabricantes y distribuidores de soportes publicitarios y sistemas de exposición de Europa. Nuestra oferta incluye, entre otros: roll-ups, paredes publicitarias, mástiles para banderas, productos de madera, estructuras para carpas y mucho más.

 Nous sommes l'un des plus grands fabricants et distributeurs de systèmes publicitaires en Europe. Notre gamme de produits comprend des bannières roll-up, des mâts de drapeau, des produits en bois, des cadres de tente et bien d'autres articles encore.



OFFICE
POZNAŃ
POLAND



WAREHOUSE
RZESZÓW
POLAND

WE GUARANTEE / GARANTIZAMOS / NOUS GARANTISSONS:



CUSTOMIZED PRICE OFFER



24/7 ONLINE ACCESS TO OUR WAREHOUSE





FAST DELIVERY TO ALL EU COUNTRIES

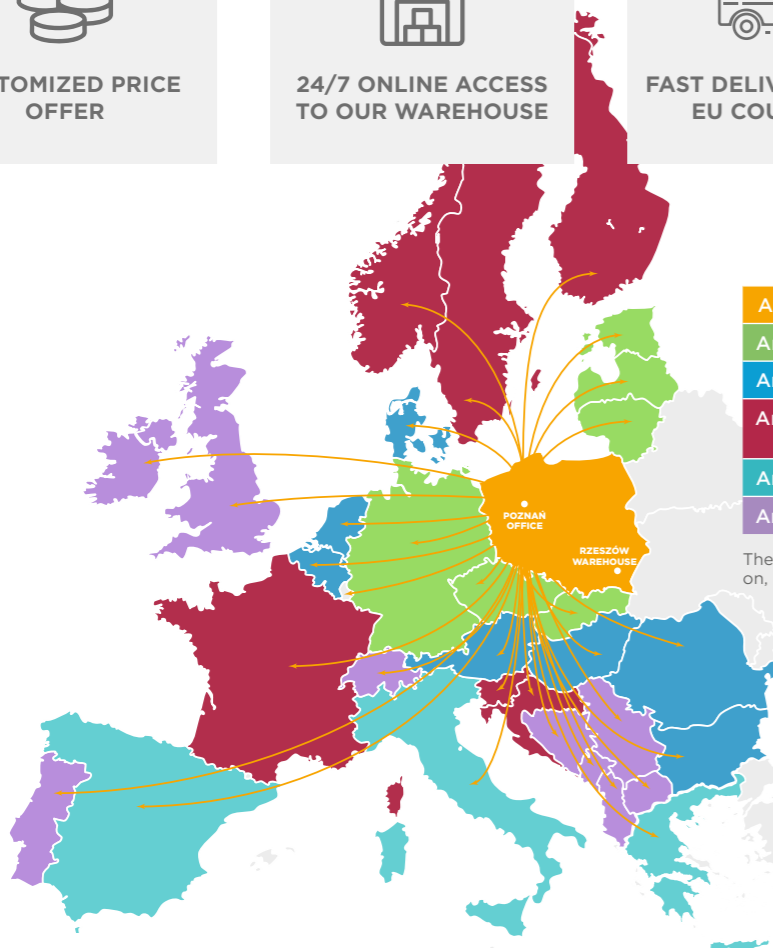

TECHNICAL SUPPORT RESULTING FROM 20 YEARS OF EXPERIENCE



		 Palette	 Parcel
Area 1	24 h	GEIS	24 h FEDEX
Area 2	2-3 days	GEIS/RABEN	2 days UPS/DPD
Area 3	2-4 days	RABEN	2-3 days DPD/UPS
Area 4	2-5 days	SCHENKER/RABEN	2-4 days UPS/GLS
Area 5	3-7 days	SCHENKER	3-5 days UPS
Area 6	delivery to be arranged individually		

The dates indicated above are working days. Dates may vary depending on, among others, weather conditions or other obstructions.



**JOIN US ON
ÚNETE A NOSOTROS
REJOIGNEZ-NOUS SUR**

WWW.PROMEDIAPLUS.PL

TABLE OF CONTENTS

INDOOR

LED It's time to shine!	5
LED BOX™ Compact	6
LED BOX™ 2.0	7
LED BOX™ Flex	8
LED BOX™ Plus 2.0	10
LED BOX™ Wall Frame	12
LUNIX™ RGB Wall	13
LUNIX™ System	14
LUNIX™ Silver	15
LUNIX™ Black	15
Backlight Wall	18
LED BOX™ Counter	20
LED BOX™ Counter With Shelf	21
LUNIX™ Counter	22
Preston Automatic Led Counter	23
Preston Automatic Oval Led	23
Preston Automatic Rectangle Led	23
Backlight Counter	24
Fabrics For Printing On Led Systems	24

TRADE FAIRS	25
LUNIX™ Exhibition Booths	26
LUNIX™ Exhibition Booths Accessories	28
Saver Case	29
Transport Cases	30

ROLL UP	31
Roll Ups Comparison	32
Compact	34
Standard	36
Standard Black	38
Standard Plus	40
Classic	42
Basic	44
Premium	46
Pro	48
Exclusive	50
Exclusive Black	52
Exclusive Plus	54
Wave	56
Clip	58
Twin	60
Roll Up Accessories	62

PAVEMENT SIGNS	118
Aurora	120
Spider	121
Hampton	122
Hampton Pro	123
Seg	124
Info Stand Chroma	124
Info/Menu Stand Puladi	125
Info/Menu Stand Classic	126
Info/Menu Stand Standard	126
Info/Menu Stand Premium	127
Metal Easel	128

WOODEN PRODUCTS	129
Chalkboard Signs Classic	130
Classic	130
Classic Natural	130
Classic Red	131
Classic Black	131
Classic Green	131
Chalkboard Sign Pro Waterproof	132
Liquid Chalk Markers	132
Chalkboard	133
Table Stands	133
Easel	133

STANDS	63
X-Banner Compact	64
X-Banner Standard	64
L-Banner	65
Atlantis Expo	66

ADVERTISING WALLS	67
Mega Seg™ System	68
Pop-Up Straight	70
Pop-Up Arc	71
Standard Magnetic Pop-Up Straight	72
Standard Magnetic Pop-Up Arc	73
Premium Magnetic Pop-Up Straight	74
Premium Magnetic Pop-Up Arc	75
Black Pro Magnetic Pop-Up Straight	76
Black Pro Magnetic Pop-Up Arc	77
Velcro Pop-Up Straight	78
Velcro Pop-Up Arc	79
Atlantis Straight	80
Atlantis Arc	81
Atlantis S-Shape	82
Atlantis U-Shape	83
Combi Systems	84
Versum	85
Advertising Wall Accessories	86

COUNTERS & BROCHURE HOLDERS	87
Promo Counters	88
Promo 2 Plus Counters	90
Topper Counter	90
Pop-Up Velcro Counter	91
Preston Counters	92
Preston Automatic Counters	94
Pop-Up Counters	95
LUNIX™ Counter	96
LED BOX™ Counter	97
LED BOX™ Counter with shelf	98
Backlight Counter	99
Brochure holders	100
Montana Silver	100
Montana Black	101
Boston	102

Atlanta	102
Columbia	103
Lincoln	103
Counter Dallas	104
Counter Concord	104
Virginia	104

POSTER FRAMES & RAILS	105
Poster Rails	106
Standard	107
Slim	107
Clip	107
Twin	107
Vertico Hanging Frames	108
Snap Frames Standard	109
Snap Frames Silver	109
Snap Frames Black	109
Snap Frames Premium	110
Magnetic Frames	111
Magnetic	111
Magnetic Reworkers	111
Magnetic Safety	111
Door Signs	112
Sonic	112
Gert	112
Elite	113
Puro	113
Manta	113
Acrylic Stands	114
Crystal	114
Platinum	114
Vista	114
Rod Systems	116
Wall To Wall System	116
Wall To Floor/Ceiling System	116
Ceiling To Floor System	117
Ceiling To Board System	117
Accessories	118

OUTDOOR

LOUNGERS	135
Wooden Lounger	136
Aluminium Lounger	136

QUEUE BARRIER	137
Premium Barrier	138
Replacement Heads	138
Hotel Barrier	139
Royal Chrome	139
Modern Chrome	139
Royal Gold	139
Modern Gold	139
Velvet Border	139
Laced Border	139
Barrier Post Info Frame	140
Wall Mounted Head	140

FLAG POLES	141
Standard Pole	142
Standard Plus Pole	143
Pro Pole	144
H Poles	145
Avenue	145
Tube Feather Flagpole	146
Tube H Flagpole	147

Pole Base	148
Rotators	152

TENT FRAMES	153
Tent Frames	154
Tent Canopy	156
Accessories	156

EVENT FURNITURES	157
Tables	158
Cocktail Table 80	158
Event Table 180x75	158
Event Table Round 122	158
Table Header	159
Tablecloth	159
Tablecloth 80	159
Tablecloth 122	159
Tablecloth 180	159
Chairs	160
Folding Chair	160
Cocktail Chair	160
Cocktail Chair Cover	160

NEW TOP HITS

SEG PAVEMENT SIGN

Sidewalk sign with a durable aluminium construction. A special lock prevents the product from being accidentally folded. A practical handle allows it to be easily transported. Mounting the fabric printout takes a few seconds.

More info - page 122



SILICONE TAPE MOUNTED PRINTOUT



NO TOOLS



DOUBLE SIDED

BACKLIGHT WALL

Illuminated advertising wall with LED curtain. Aluminium light strips with a huge number of bulbs evenly illuminate the entire printout. The back of the curtain does not let light through, which allows the graphics to be highlighted even better.

More info - page 18-19



UP TO 960 LED BULBS



SILICONE TAPE MOUNTED PRINTOUT



NO TOOLS



WHEELED BAG

LUNIX™ RGB WALL

A unique LED system with a built-in lighting colour change mechanism. A wide aluminium profile (12 cm) ensures high quality and stability of the entire system. RGB walls can be connected to the LUNIX™ system, to create unique structures.

More info - page 13

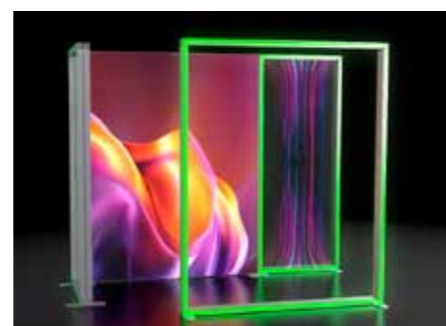

WIDE ALUMINIUM PROFILE



NO TOOLS



SILICONE TAPE MOUNTED PRINTOUT



WHEELED BAG



DOUBLE SIDED

Lighting colours:



It's time to shine!

LED

LED BOX™ COMPACT

NEW!

- double-sided LED system
- aluminium frame (6,5 cm)
- design based on quick-connects for powering the integrated LED lighting

The set includes: LED BOX Compact, power adapter, silicon tape, cardboard case.

- sistema LED de doble cara
- perfil de aluminio (6,5 cm)
- diseño basado en conexiones rápidas para alimentar la iluminación LED integrada

El conjunto incluye: LED BOX Compact, adaptador de corriente, cinta de silicona, caja de cartón.

- système LED, double face
- cadre en aluminium (6,5 cm)
- construction basée sur des connecteurs rapides pour l'alimentation de l'éclairage LED intégré

Le kit comprend: un système LED BOX Compact, une alimentation, un ruban silicone, une valise en carton.



LED



POWER VIA QUICK-CONNECTORS



6,5 cm
ALUMINIUM PROFILE



NO TOOLS





DOUBLE SIDED

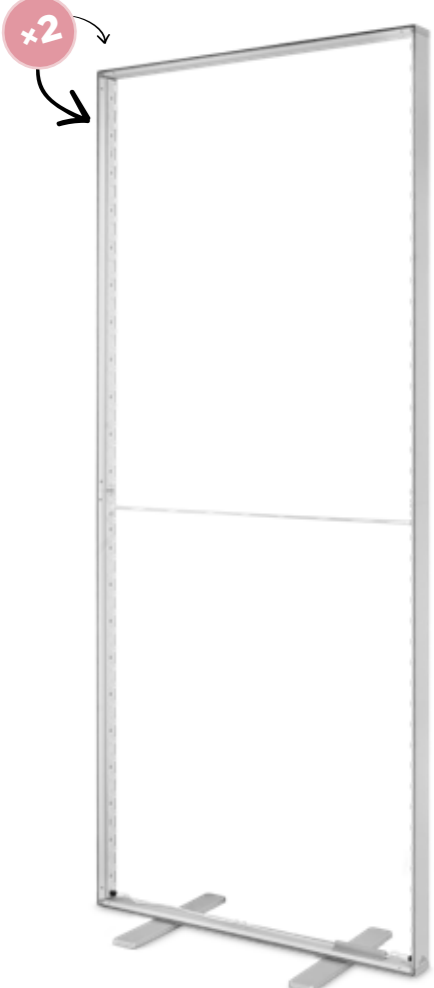

SILICONE TAPE MOUNTED PRINTOUT







LED BOX™ 2.0

NEW!

- double-sided LED system
- durable aluminium frame (8,5 cm)
- design based on quick-connects for powering the integrated LED lighting
- the LED bulbs do not exceed the profile
- available in cardboard case or wheeled bag

The set includes: LED BOX 2.0, power adapter, silicon tape, cardboard case/transport bag.

- sistema LED de doble cara
- perfil de aluminio (8,5 cm)
- diseño basado en conexiones rápidas para alimentar la iluminación LED integrada
- las bombillas LED no sobresalen del perfil
- disponible en caja de cartón o bolsa con ruedas

El conjunto incluye: LED BOX 2.0, adaptador de corriente, cinta de silicona, caja de cartón/bolsa de transporte.

- système LED, double face
- cadre en aluminium durable (8,5 cm)
- construction basée sur des connecteurs rapides pour l'alimentation de l'éclairage LED intégré
- les ampoules LED ne dépassent pas du profilé
- disponible en carton ou en sac à roulettes

Le kit comprend: un système LED BOX 2.0, une alimentation, un ruban silicone, un carton/un sac de transport.



LED



POWER VIA QUICK-CONNECTORS



8,5 cm
ALUMINIUM PROFILE



NO TOOLS



DOUBLE SIDED



SILICONE TAPE MOUNTED PRINTOUT



AVAILABLE COLOURS:







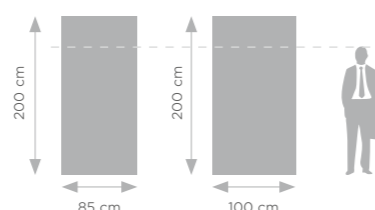

LED BOX 2.0 PRODUCTS CAN BE CONNECTED TO EACH OTHER USING PARALLEL OR CORNER CONNECTORS.

Size	Barcode	Weight
85x200	5904423600791	5,5 kg
100x200	5904423600807	5,7 kg



Recommended media and printing technology for this system:

 Fabric Sublimation printing

Size	Barcode	Weight
100x200 (silver)	5907451664001	7 kg
100x200 (silver / bag)	5907451666906	7 kg
100x230 (silver)	5907451669921	9 kg
100x230 (silver / bag)	5907451666913	9 kg
100x250 (silver)	5907451669914	12 kg
100x250 (silver / bag)	5907451666920	12 kg
100x200 (black)	5907451667507	7 kg
100x230 (black)	5907451667514	9 kg
100x250 (black)	5907451667521	12 kg

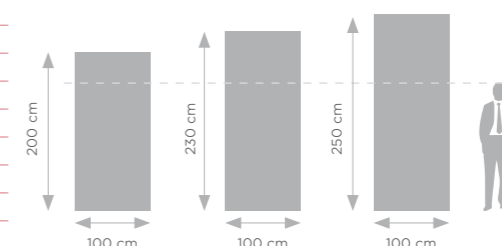

Recommended media and printing technology for this system:

 Fabric Sublimation printing

LED BOX™ FLEX

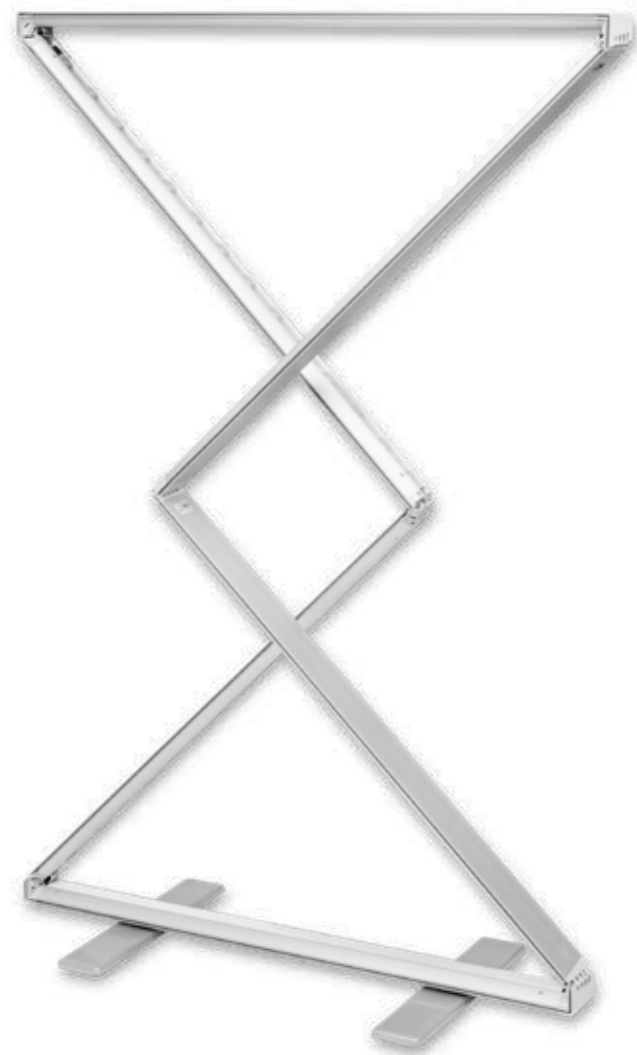

- flex system - faster and easier assembly thanks to its hinge-based construction
 - durable aluminium frame (8,5 cm)
 - Integrated LED lighting powered by quick-connectors (power cables hidden in the aluminium profiles)
 - silicon tape mounted printout
 - no tools assembly
- The set includes: LED BOX FLEX, power adapter, transport bag.

- sistema flex - montaje más rápido y sencillo gracias a su estructura con bisagras
- perfil de aluminio (8,5 cm)
- construcción basada en conectores rápidos que suministran iluminación LED
- montaje sin herramientas
- impresión montada con cinta de silicona

El juego incluye: LED BOX FLEX, fuente de alimentación, bolsa de transporte.

- système flex - assemblage plus rapide et plus facile grâce à sa construction à charnières
- profilé aluminium (8,5 cm)
- l'éclairage LED intégré, alimenté par des connecteurs rapides (câbles d'alimentation dissimulés dans les profilés en aluminium)
- montage sans outils
- impression montée sur ruban en silicone

Le kit comprend: LED BOX FLEX, une alimentation, un sac de transport.



LED BOX FLEX IS DISTINGUISHED BY ITS HINGE-BASED CONSTRUCTION, WHICH SIMPLY NEEDS TO BE OPENED.

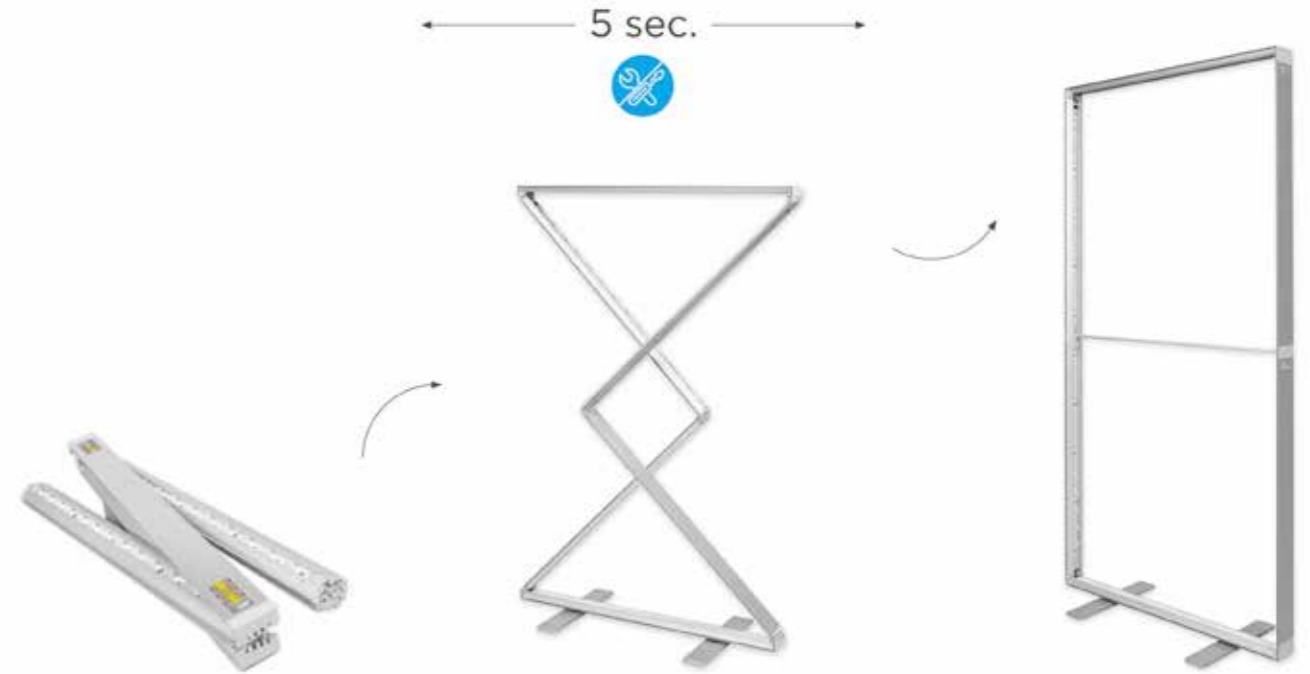

THANKS TO EMBEDDED MAGNETS, THE LED BOX FLEX PRODUCTS CAN BE CONNECTED IN SERIES TO EACH OTHER FOR CREATING SYSTEMS OF DIFFERENT SIZE.

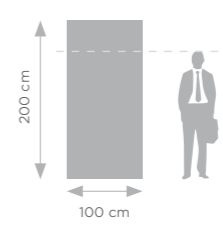
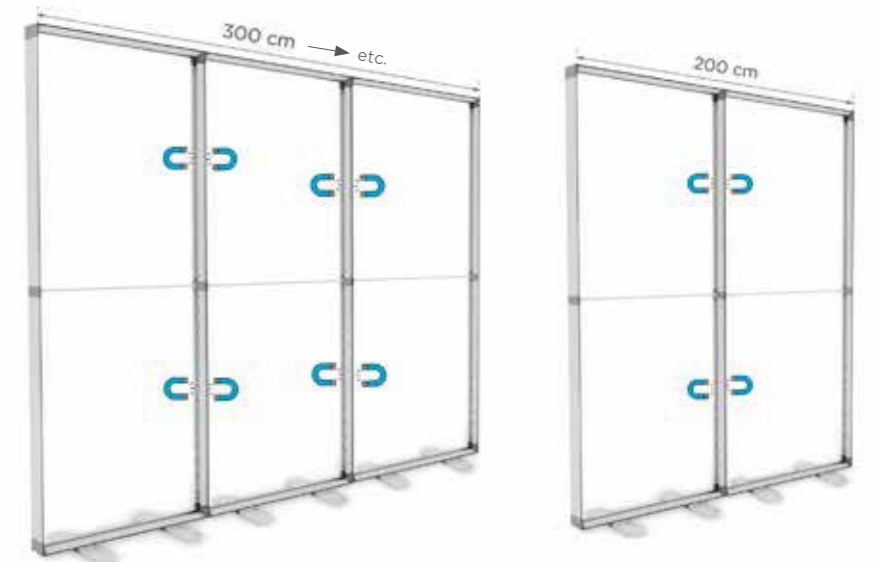

100x200	5907451667415	7 kg
---------	---------------	------

Recommended media and printing technology for this system:

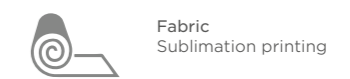

LED BOX™ PLUS 2.0

NEW!



10 cm
WIDE
ALUMINIUM
PROFILE



SILICONE TAPE
MOUNTED
PRINTOUT



NO TOOLS



DOUBLE
SIDED



WHEELED
BAG

- double-sided LED system
- wide aluminium profile (10 cm)
- flex system - faster and easier assembly thanks to its hinge-based construction
- wheeled transport bag

The set includes: LED BOX PLUS 2.0 wall, power adapter, silicon tape, transport bag.

- sistema LED de doble cara
- perfil ancho de aluminio (10 cm)
- flex sistema - montaje más rápido y sencillo gracias a su construcción con bisagras
- bolsa de transporte con ruedas

El conjunto incluye: LED BOX PLUS 2.0 pared, adaptador de corriente, cinta de silicona, bolsa de transporte.

- système double face et retroéclairage
- profilé aluminium large (10 cm)
- système flex - installation plus rapide et plus facile grâce à la conception basée sur les charnières
- sac de transport à roulettes

Le kit comprend: un système LED BOX PLUS 2.0, un ruban silicone, une alimentation, un sac de transport.



LED BOX PLUS 2.0 IS DISTINGUISHED BY ITS HINGE-BASED CONSTRUCTION, WHICH SIMPLY NEEDS TO BE OPENED.

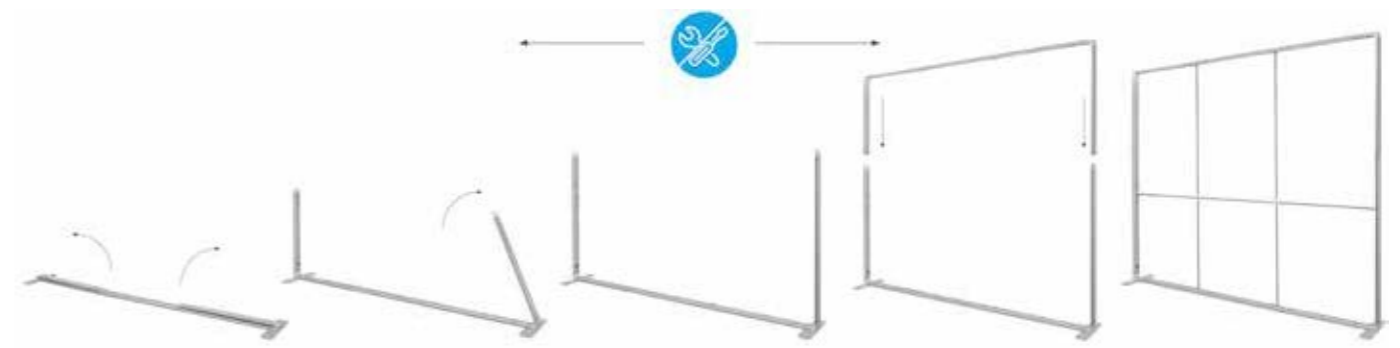

LED BOX PLUS 2.0 PRODUCTS CAN BE CONNECTED TO EACH OTHER USING PARALLEL OR CORNER CONNECTORS.

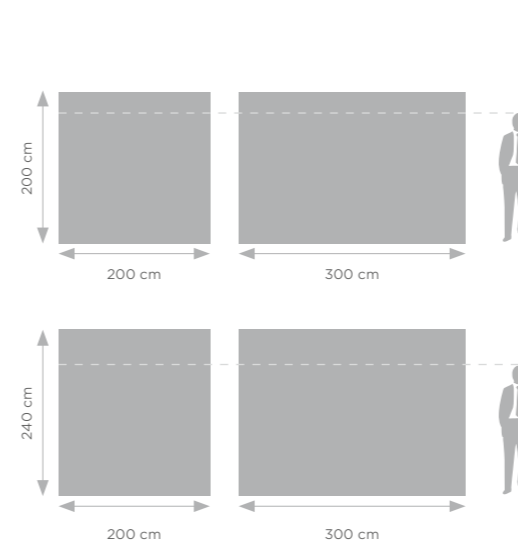

200x200	5907451668870	15 kg
300x200	5907451668856	22 kg
200x240	5907451668863	16 kg
300x240	5907451668849	23 kg



Recommended media and printing technology for this system:



Fabric
Sublimation printing

LED BOX™ WALL FRAME

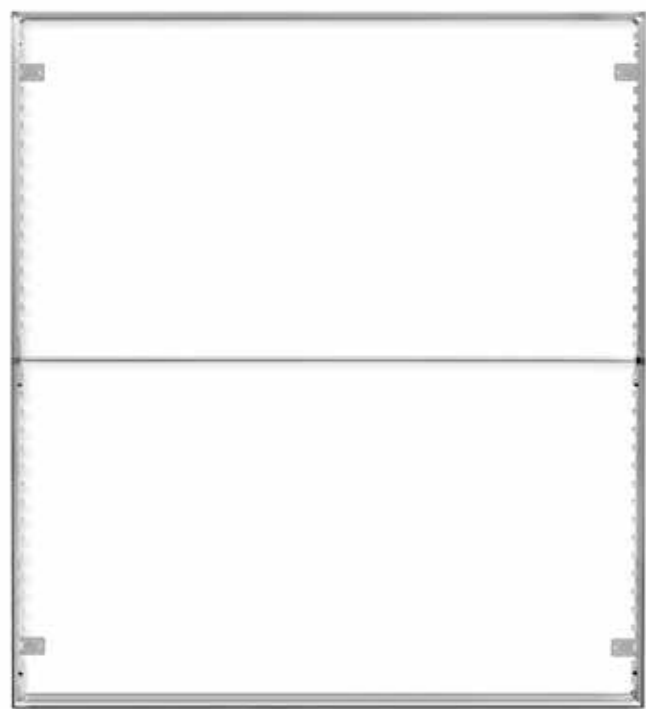

- LED
- 8 cm ALUMINIUM PROFILE
- SILICONE TAPE MOUNTED PRINTOUT
- NO TOOLS

- suspended LED system
- durable aluminium frame (8 cm)
- no tools assembly
- silicon tape mounted printout

The set includes: LED BOX WALL FRAME, mounting accessories, power cable.

- sistema LED suspendido
- perfil ancho de aluminio (8 cm)
- instalación sin herramientas
- impresión montada con cinta de silicona

El juego incluye: LED BOX marco de pared, accesorios de montaje, cable de alimentación.

- système LED suspendu
- montage sans outils
- l' image montée à l'aide d'une bande silicone
- construction en aluminium (8 cm)

Le kit comprend: LED BOX WALL FRAME, accessoires de montage, une alimentation.

91,5x91,5	5907451668481	2,3 kg
100x150	5907451666425	4,5 kg

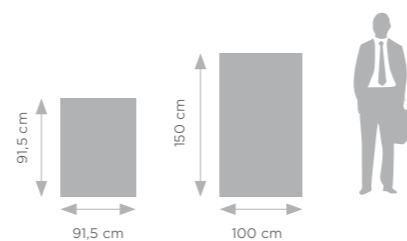

Recommended media and printing technology for this system: Fabric Sublimation printing

LUNIX™ RGB WALL

PREMIUM LINE

NEW!

- double-sided LED system
- built-in light colour change mechanism (6 colours in 1 system)
- wide aluminium profile (12 cm)
- silicon tape mounted printout
- wheeled transport bag

The set includes: LUNIX™ RGB wall, power adapter, transport bag.

- sistema LED de doble cara
- mecanismo integrado de cambio de color de la luz (6 colores en 1 sistema)
- perfil de aluminio ancho (12 cm)
- impresión montada con cinta de silicona
- bolsa de transporte con ruedas

El conjunto incluye: LUNIX™ RGB pared, adaptador de corriente, bolsa de transporte.

- système LED double face
- mécanisme intégré de changement de couleur de la lumière (6 couleurs dans 1 système)
- profilé large en aluminium (12 cm)
- impression montée sur ruban en silicone
- sac de transport à roulettes

Le kit comprend: mur LUNIX™ RGB, une alimentation, un sac de transport.

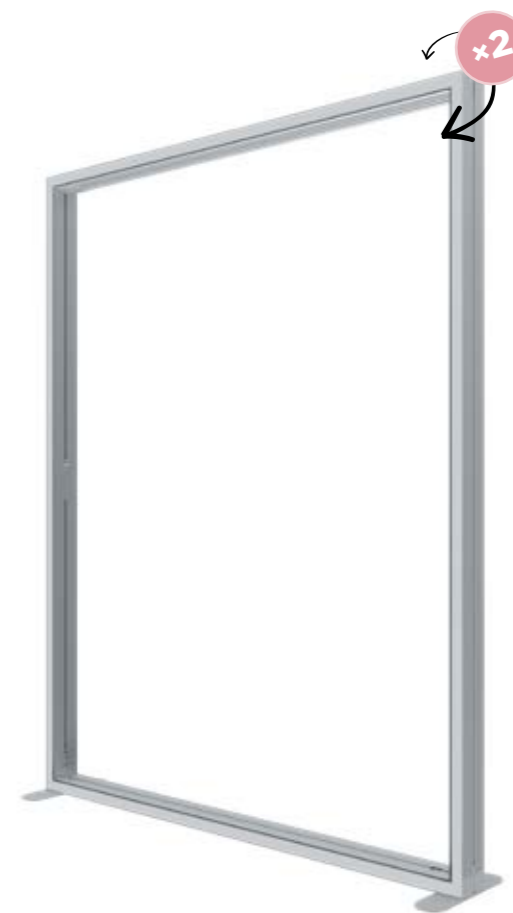

WIDE ALUMINIUM PROFILE



NO TOOLS



SILICONE TAPE MOUNTED PRINTOUT



WHEELED BAG



DOUBLE SIDED

RGB WALLS CAN BE CONNECTED TO EACH OTHER. THEY CAN ALSO BE CONNECTED TO THE LUNIX™ SYSTEM. TO COMBINE SYSTEMS USE LUNIX™ CONNECTORS (E.G.: T, X, TRIANGLE, 45° /60° /90° OR TOP CONNECTOR).

Lighting colours:

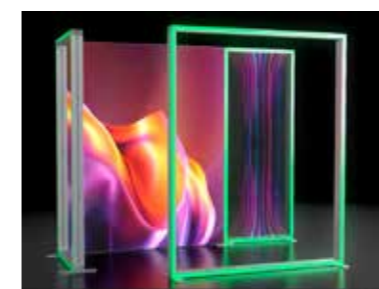
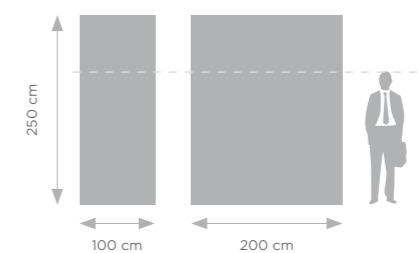
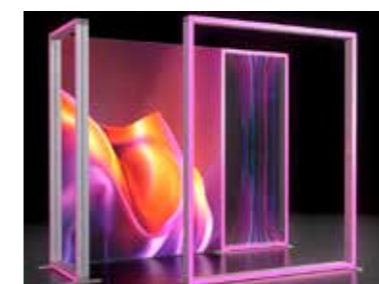

100x250	5907451669839	19 kg
200x250	5907451664797	24,2 kg

Recommended media and printing technology for this system:

Fabric Sublimation printing

LUNIX™ SYSTEM



- LED
- MODULAR
CONSTRUCTION
- 12 cm
WIDE
ALUMINIUM
PROFILE
- NO TOOLS
- SILICONE TAPE
MOUNTED
PRINTOUT
- WHEELED
BAG

UK ■ double-sided LED system
 ■ **modular construction**
 ■ **wide aluminium profile (12 cm)**
 ■ no tools assembly
 ■ silicon tape mounted printout
 ■ sturdy Premium wheeled bag
 The set includes: LUNIX™ system, power adapter, transport bag.

ES ■ sistema LED de doble cara
 ■ **construcción modular**
 ■ **perfil ancho de aluminio (12 cm)**
 ■ montaje sin herramientas
 ■ impresión montada con cinta de silicona
 ■ bolsa con ruedas Premium resistente
 El set incluye: sistema LUNIX™, fuente de alimentación, bolsa de transporte.

FR ■ système LED double face
 ■ **construction modulaire**
 ■ **profilé large en aluminium (12 cm)**
 ■ montage sans outils
 ■ impression montée sur ruban silicone
 ■ sac à roulettes robuste Premium
 Le kit comprend: un système LUNIX™, alimentation, un sac de transport.

LUNIX™ SYSTEM
 quality recognized
 by TÜV!

TÜV-certified - International certification
 of quality and safety



Safety
 Regular
 Production
 Surveillance



www.tuv.com
 ID 000088556

LUNIX™ SILVER



LUNIX™ BLACK



THE LUNIX™ IS ONE OF THE MOST IMPRESSIVE TRADE FAIR SYSTEM!

Wide range of accessories allows to connect the LUNIX™ systems to each other for creating unique exhibition stands.



CHECK OUR READY-MADE EXHIBITION BOOTHS - PAGES 26-28

THE LUNIX™ SYSTEMS CAN BE EXPANDED THANKS TO THE MODULAR CONSTRUCTION.

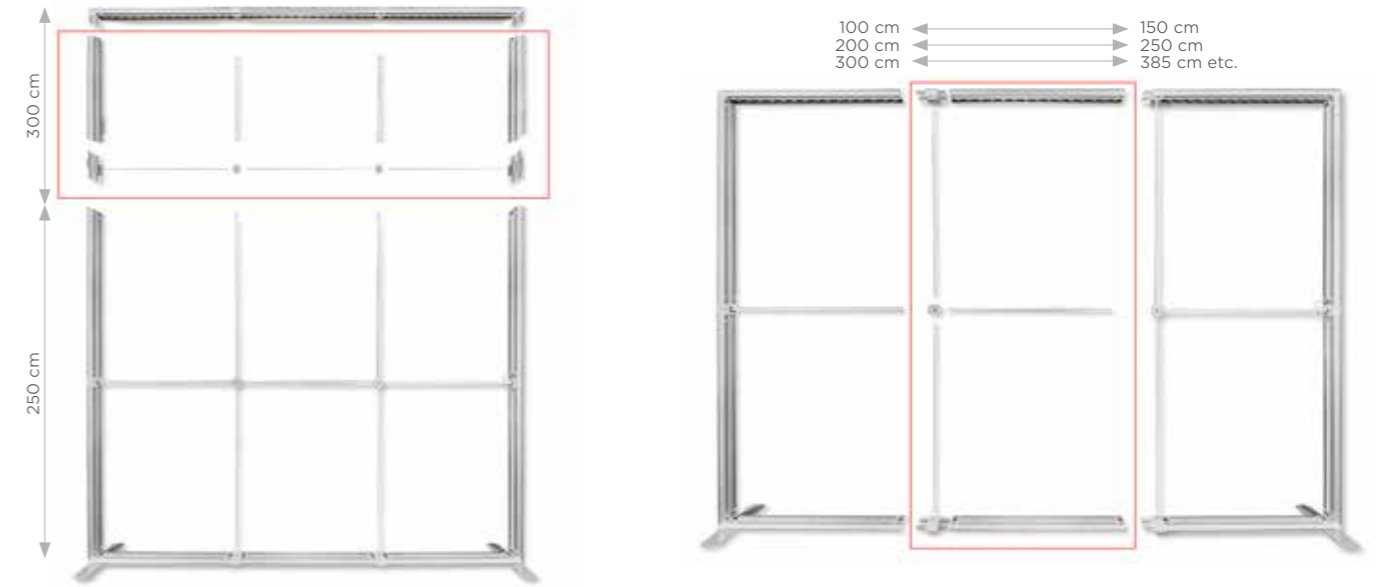

The Long Set allows to heighten the LUNIX™ by 50 cm - up to 300 cm.

The XL Set enables to increase the LUNIX™ system width by 50, 85 or 100 cm.

Exhibition booth accessories make the LUNIX™ system even more functional.

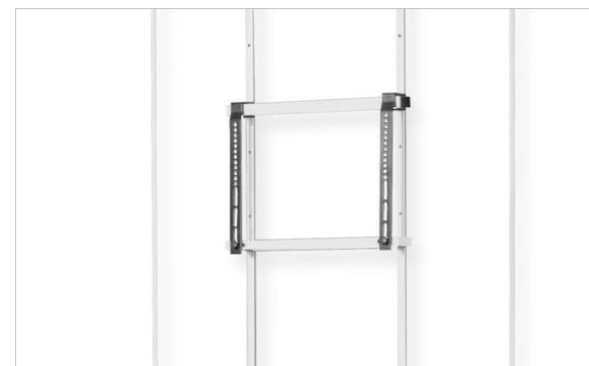

A special monitor holder ensures additional multimedia presentation.



A practical shelves system enables additional display of products or advertising materials.



A illuminated storage room is a great solution to store materials needed during trade fairs.



A practical, illuminated roof allows to create even more eye-catching exhibition booth.

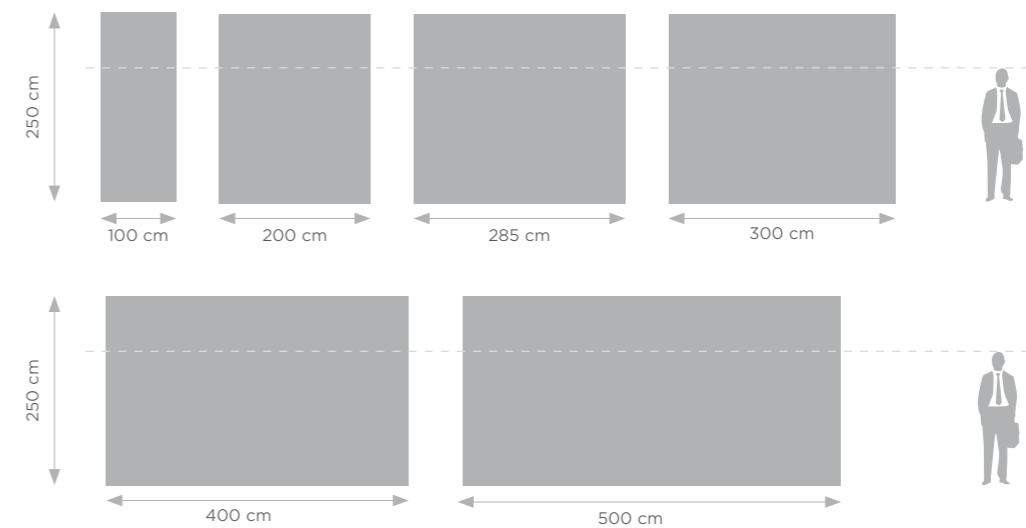

100x250 (silver)	5907451667361	12 kg
200x250 (silver)	5907451667002	21 kg
285x250 (silver)	5907451667187	26 kg
300x250 (silver)	5907451667019	27 kg
400x250 (silver)	5907451667026	29 kg
500x250 (silver)	5907451667033	36 kg
200x250 (black)	5907451669976	21 kg
285x250 (black)	5907451669426	26 kg
300x250 (black)	5907451669419	27 kg
400x250 (black)	5907451669846	29 kg
500x250 (black)	5907451669792	36 kg

Recommended media and printing technology for this system:



Fabric
Sublimation printing

BACKLIGHT WALL



NEW!



UP TO 960 LED BULBS



ALUMINIUM PROFILE



SILICONE TAPE MOUNTED PRINTOUT



NO TOOLS



WHEELED BAG



BACKLIGHT WALLS CAN BE CONNECTED TO EACH OTHER USING PARALLEL OR CORNER CONNECTORS.

200x250	5907451662618	25 kg
300x250	5907451662663	29 kg
400x250	59078451668566	39 kg
500x250	5907451668580	48 kg
600x250	5904423600036	52 kg

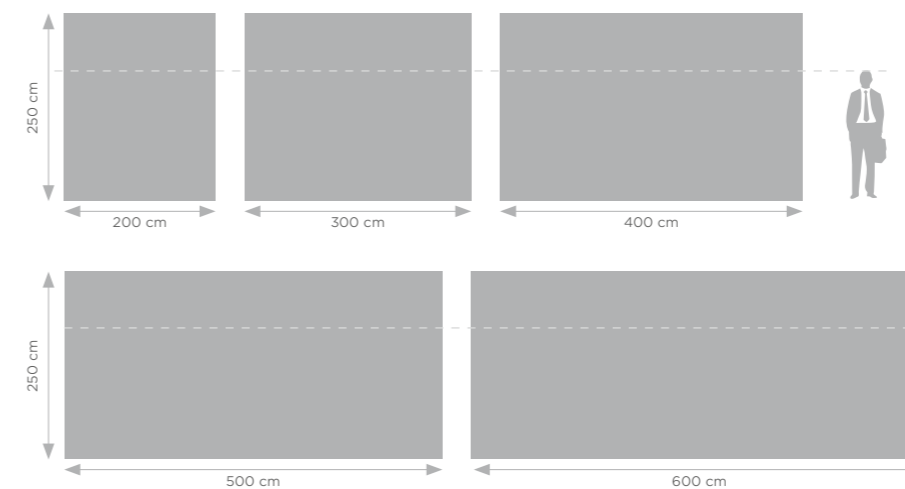

- LED curtain enables the entire printout to be evenly illuminated
- the back of the curtain is opaque, which allows for even better highlighting of the graphics
- aluminium light strips
- aluminium profile (6.5 cm)
- wheeled bag

The set includes: BACKLIGHT wall, LED curtain, power adapter, transport bag.

- la cortina LED permite iluminar uniformemente toda la impresión
- la parte posterior de la cortina es opaca, lo que permite resaltar aún mejor los gráficos
- tiras de luz de aluminio
- perfil de aluminio (6,5 cm)
- bolsa con ruedas

El conjunto incluye: pared BACKLIGHT, cortina LED, fuente de alimentación, bolsa de transporte.

- le rideau LED permet d'éclairer uniformément l'ensemble de l'impression
- l'arrière du rideau ne laisse pas passer la lumière, ce qui permet de mettre encore plus en valeur les graphismes
- bandes lumineuses en aluminium
- profilé en aluminium (6,5 cm)
- sac à roulettes

Le kit comprend: un mur BACKLIGHT, rideau LED, alimentation, un sac de transport.

Recommended media and printing technology for this system:



Fabric Sublimation printing

LED BOX™ COUNTER



- double-sided LED system
 - durable aluminium frame (8 cm)
 - no tools assembly
 - silicon tape mounted printout
- The set includes: LED BOX counter, power adapter, transport bag.

- iluminación LED integrada
 - perfil de aluminio (8 cm)
 - montaje sin herramientas
 - impresión montada con cinta de silicona
- El conjunto incluye: mostrador LED BOX, adaptador de corriente, bolsa de transporte.

- rétroéclairé, double face et facile à utiliser
 - aluminium anodisé solide (8 cm)
 - montage sans outils
 - l'image montée à l'aide d'une bande silicone
- Le kit comprend: un comptoir LED BOX, une alimentation, un sac de transport.

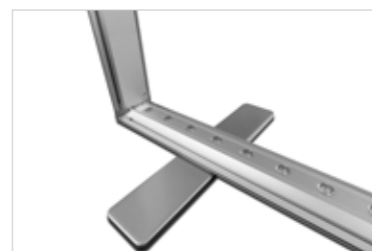

Counter Table top



Recommended media and printing technology for this system:



LED BOX™ COUNTER WITH SHELF

NEW!



- LED counter with practical shelf
 - aluminium frame (6,5 cm)
 - no tools assembly
 - silicon tape mounted printout
- The set includes: LED BOX with shelf counter, blackback material, power adapter, transport bag.

- mostrador LED con práctico estante
 - perfil de aluminio (6,5 cm)
 - montaje sin herramientas
 - impresión montada con cinta de silicona
- El conjunto incluye: LED BOX mostrador con estante, blackback material, adaptador de corriente, bolsa de transporte.

- comptoir LED avec étagère pratique
 - profilé en aluminium (6,5 cm)
 - montage sans outils
 - impression montée sur ruban silicone
- Le kit comprend : un comptoir LED BOX avec étagère, un blackback matériau, une alimentation, un sac de transport.

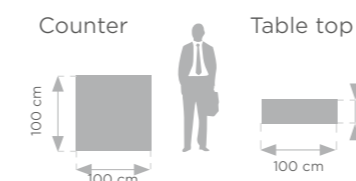

Recommended media and printing technology for this system:



LUNIX™ COUNTER

PREMIUM LINE



- double-sided system
 - **wide aluminium profile (12 cm)**
 - integrated LED lighting
 - no tools assembly
 - silicon tape mounted printout
 - wheeled transport bag
- The set includes: LUNIX™ counter, power adapter, transport bag.

- sistema doble cara
 - **perfil ancho de aluminio (12 cm)**
 - iluminación LED integrada
 - montaje sin herramientas
 - impresión montada con cinta de silicona
 - bolsa de transporte con ruedas
- El conjunto incluye: mostrador LUNIX™, adaptador de corriente, bolsa de transporte.

- système double face
 - **large profilé en aluminium (12 cm)**
 - éclairage LED intégré
 - assemblage sans outils
 - impression sur ruban adhésif siliconé
 - sac de transport à roulettes
- Le kit comprend: un comptoir LUNIX™, une alimentation, un sac de transport.

- LED
- 12 cm WIDE ALUMINIUM PROFILE
- SILICONE TAPE MOUNTED PRINTOUT
- NO TOOLS
- DOUBLE SIDED
- WHEELED BAG

Available table top colours:

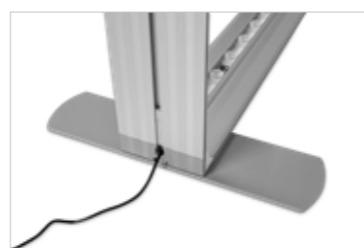

5907451667422 10 kg

Fabric Sublimation printing

PRESTON AUTOMATIC LED COUNTER

- automatic, no tools assembly
 - LED system
 - silicone tape mounted print-out
- The set includes: PRESTON counter, transport bag.

- automático
 - sistema LED
 - montaje sin herramientas
 - impresión montada con cinta de silicona
- El conjunto incluye: mostrador PRESTON, bolsa de transporte.

- dépliage automatique du comptoir
 - éclairage LED intégré
 - l'image lumineuse montée avec une bande en silicone
- Le kit comprend: un comptoir PRESTON, un sac de transport.

Recommended media and printing technology for this system: Fabric Sublimation printing

PRESTON AUTOMATIC OVAL LED

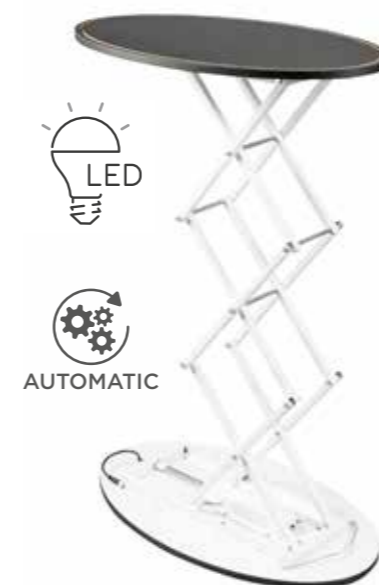

AUTOMATIC

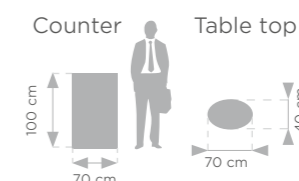

5907451665268 11 kg

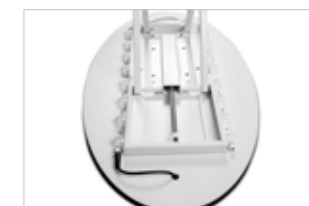

PRESTON AUTOMATIC RECTANGLE LED



AUTOMATIC

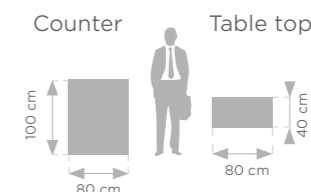

5907451665244 12 kg



BACKLIGHT COUNTER

NEW!

UK LED curtain enables the entire printout to be evenly illuminated

- aluminium light strips
- aluminium profile (6.5 cm)

The set includes: BACKLIGHT counter, LED curtain, power adapter, transport bag.

ES la cortina LED permite iluminar uniformemente toda la impresión

- tiras de luz de aluminio
- perfil de aluminio (6,5 cm)

El conjunto incluye: mostrador BACKLIGHT, cortina LED, fuente de alimentación, bolsa de transporte.

FR le rideau LED permet d'éclairer uniformément l'ensemble de l'impression

- bandes lumineuses en aluminium
- profilé en aluminium (6,5 cm)

Le kit comprend: un comptoir BACKLIGHT, rideau LED, une alimentation, un sac de transport.

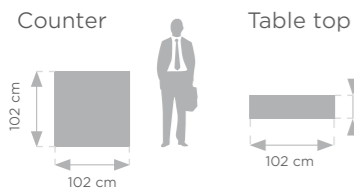
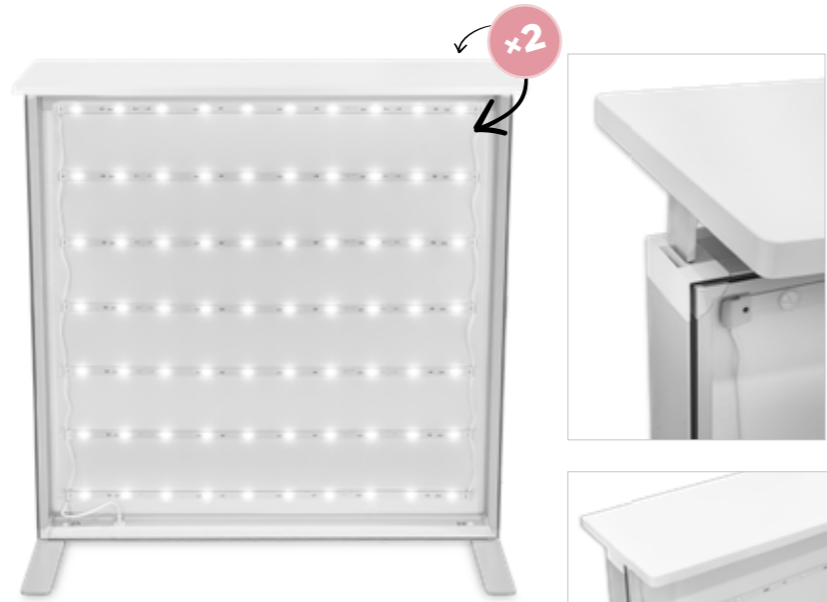

Recommended media and printing technology for this system:



FABRICS FOR PRINTING ON LED SYSTEMS

NEW!

UK high-quality fabric for LED systems

- diffuses light well
- flexible

ES tejido de alta calidad para sistemas LED

- dispersa bien la luz
- elástico

FR tissu de haute qualité pour les systèmes LED

- diffuse bien la lumière
- flexible

	Width (m)	Barcode
Backlight Samba 180 g	1,6	5904423600418
Backlight Samba 180 g	3,2	5907451664360
Backlit Lumitex 270 g	1,6	5904423600425
Backlit Lumitex 270 g	3,2	5907451664131
Blackback 260 g	3,2	5907451664094

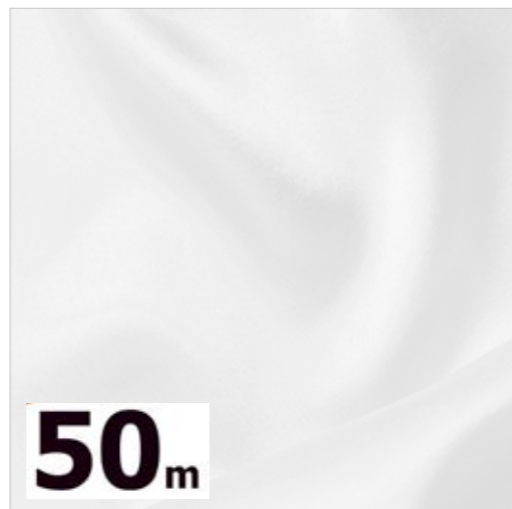

TRADE FAIRS

LUNIX™ EXHIBITION BOOTHS

PREMIUM LINE

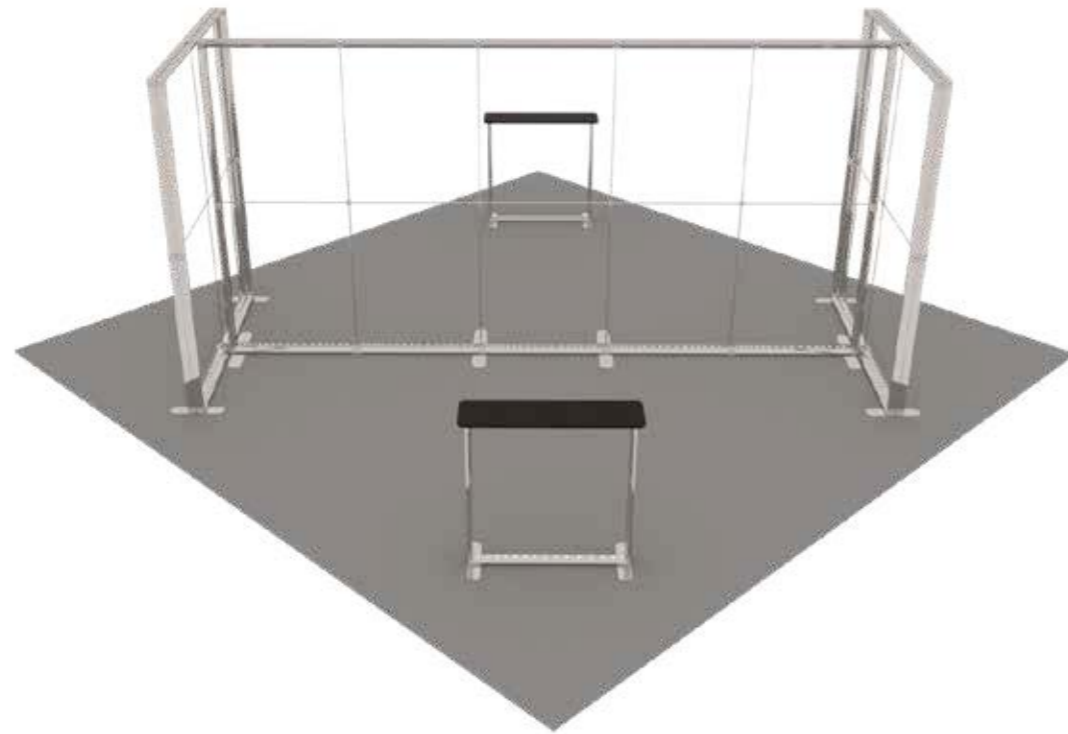

- LED
- 12 cm
WIDE ALUMINIUM PROFILE
- MODULAR CONSTRUCTION
- DOUBLE SIDED
- NO TOOLS
- SILICONE TAPE MOUNTED PRINTOUT
- WHEELED BAG

THE LUNIX™ EXHIBITION BOOTH CONSISTS OF THE LUNIX™ SYSTEM (MORE INFO PAGES 14-17) AND THE LUNIX™ COUNTER (MORE INFO - PAGE 22)

- eye-catching LED exhibition stand
- perfil de aluminio ancho (12 cm)**
- no tools assembly
- silicon tape mounted printout
- sturdy wheeled transport bag

The set includes: LUNIX™ system, LUNIX™ counter, transport bags, assembly accessories.

- sistema LED
- perfil de aluminio ancho (12 cm)**
- montaje sin herramientas
- impresión montada con cinta de silicona
- maleta de transporte con ruedas

El conjunto incluye: sistema LUNIX™, mostrador LUNIX™, bolsa de transporte y accesorios de montaje.

- éclairage LED intégré
- cadre épais en aluminium (12 cm)**
- montage sans outils
- l'image montée à l'aide d'une bande silicone
- sac à roulettes

Le kit comprend: système LUNIX™, comptoir LUNIX™, sac de transport, accessoires de montage.

16 m ² /island	5907451667996
25 m ² /island	5907451667989
36 m ² /island	5907451667972
9 m ² /peninsula	5907451667965
12 m ² /peninsula	5907451667941
15 m ² /peninsula	5907451667934
16 m ² /peninsula	5907451667958
18 m ² /peninsula	5907451667910
24 m ² /peninsula/1 counter	5907451667927
24 m ² /peninsula/2 counters	5907451667903
9 m ² /corner	5907451667897
15 m ² /corner	5907451667859
25 m ² /corner	5907451667873

EXAMPLES OF THE LUNIX™ EXHIBITION BOOTHS



Recommended media and printing technology for this system:



Fabric Sublimation printing

LUNIX™ EXHIBITION BOOTHS ACCESSORIES

MONITOR HOLDER

UK A special monitor holder allows additional multimedia presentation. This is an ideal alternative to traditional posters or banners, which increases the efficiency of the entire booth.

ES Un soporte especial para monitores permite realizar presentaciones multimedia adicionales. Se trata de una alternativa ideal a los carteles o pancartas tradicionales, lo que aumenta la eficiencia de todo el stand.

FR Le porte-écran spécial permet une présentation multimédia supplémentaire de l'offre. Il est une alternative idéale aux affiches ou aux bannières traditionnelles, augmentant ainsi l'attrait du stand.

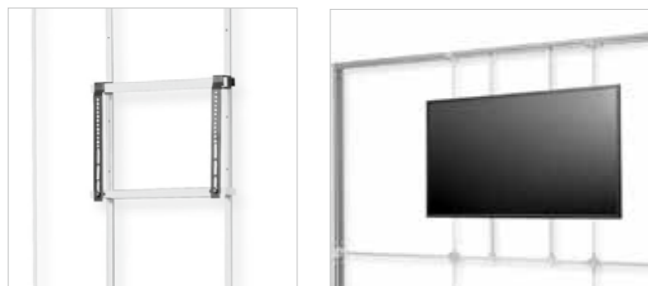

LOCKER SET

UK The illuminated storage room with a code lock is a great solution to store materials needed during trade fairs or other promotional events.

ES El trastero iluminado con cerradura de código es una solución ideal para guardar el material necesario durante ferias u otros eventos promocionales.

FR Le casier lumineux avec serrure à code est une solution idéale pour stocker le matériel nécessaire lors de salons professionnels ou d'autres événements.



SHELVES SYSTEM

UK The shelves system makes the LUNIX™ products even more functional. The shelves can be mounted horizontally or diagonally.

ES El sistema de estantes hace que los productos LUNIX™ sean aún más funcionales. Los estantes se pueden montar horizontal o diagonalmente.

FR Grâce aux étagères le système LUNIX™ devient un espace encore plus fonctionnel pour les salons. Les étagères peuvent être installées horizontalement ou en diagonale.



ROOF

UK A practical accessory for the LUNIX™ system. Similar to the LUNIX™ system, the product features a high-quality, aluminium construction with a wide profile (12 cm), integrated LED lighting and tool-free assembly.

ES Un accesorio práctico para el sistema LUNIX™. Al igual que el sistema LUNIX™, el producto cuenta con una estructura de aluminio de alta calidad con un perfil ancho (12 cm), iluminación LED integrada y montaje sin herramientas.

FR Un accessoire pratique pour le système LUNIX™. Le produit, identique au système LUNIX™, est doté d'un éclairage LED intégré, d'un large profilé en aluminium (12 cm), de graphiques recto-verso et d'un assemblage sans outil.



SAVER CASE

NEW!

UK ■ **wheeled trade fair case with counter option**
 ■ large size and straps securing the contents
 ■ practical wheels and a handle ensures easy transport
 ■ fabric printout

The set includes: Saver case, individual carton box.

ES ■ **maleta con ruedas para ferias con opción de mostrador**
 ■ gran tamaño y correas para asegurar el contenido
 ■ prácticas ruedas y asa que garantizan un transporte fácil
 ■ impresión en tela

El conjunto incluye: Saver case, caja de cartón individual.

FR ■ **valise à roulettes avec option comptoir**
 ■ la grande taille et les sangles pour fixer le contenu
 ■ des roues pratiques et une poignée facilitent le déplacement de l'ensemble
 ■ impression sur tissu

Le set comprend: Saver case, emballage en carton.

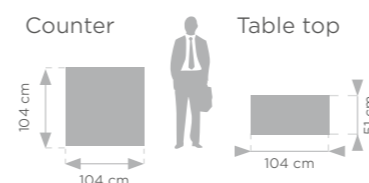

	capacity		
104x51x104 cm	80 kg	5907451668511	11 kg

Recommended media and printing technology for this system:

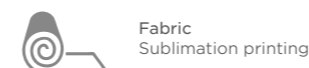

TRANSPORT CASES

NEW!



- practical case for advertising materials
 - product made of HDPE material - a very durable high-density polyethylene
 - straps protecting the contents inside and outside
 - practical wheels and a handle ensure easy transport
- The set includes: case, individual carton box.



- maletín práctico para materiales publicitarios
 - producto fabricado en HDPE, un polietileno de alta densidad muy resistente
 - correas que protegen el contenido por dentro y por fuera
 - prácticas ruedas y asa que facilitan el transporte
- El conjunto incluye: maletín y caja de cartón individual.



- valise pratique pour le transport de matériel publicitaire
 - produit fabriqué en HDPE - un polyéthylène haute densité très résistant
 - sangles protégeant le contenu à l'intérieur et à l'extérieur
 - roulettes pratiques et poignée facilitant le transport
- Le kit comprend: une valise rigide pour salon, un carton individuel.

	capacity		
S - 134x43x27 cm	102 L	5907451660362	6 kg
L - 165x40x27 cm	105 L	5907451660393	11 kg

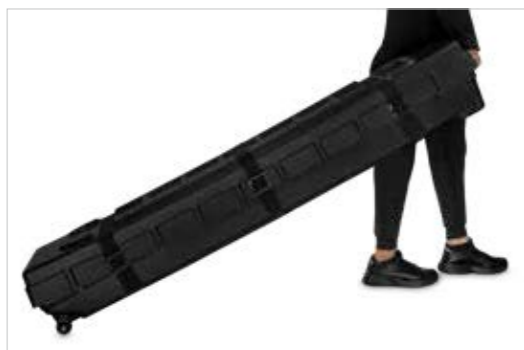

ROLL UP

ROLL UPS COMPARISON

Type of bags	
S	Standard bag
SL	Standard long zip bag
PL	Premium long zip bag
P	Premium bag

Product name	Side view	Foot view	Size	KG	Single-sided (S) or double-sided (D) print
Compact			80x200	1,5	S
			85x200	1,56	S
			100x200	1,73	S
Standard			85x200	1,64	S
			100x200	2	S
			120x200	2,4	S
Standard Black			85x200	1,64	S
			100x200	1,9	S
			120x200	2,4	S
Standard Plus			85x200	1,6	S
			100x200	2	S
			120x200	2,4	S
			150x200	3,05	S
Classic			80x200	1,85	S
			85x200	2	S
			100x200	2,24	S
			120x200	2,87	S
			150x200	3,46	S
Basic			80x200	1,9	S
			85x200	2,1	S
			100x200	2,5	S
			120x200	3	S
			150x200	3,7	S
Premium			80x200	2	S
			85x200	2,2	S
			100x200	2,7	S
			120x200	3,5	S
			150x200	4	S
Pro			85x200	2,7	S
			100x200	3,1	S
			120x200	3,7	S
			150x200	4,7	S
			200x200	6,2	S
Exclusive			85x200	2,7	S
			100x200	3,2	S
			120x200	3,8	S
			150x200	4,8	S
			200x200	6,4	S
Exclusive Black			85x200	2,7	S
			100x200	3,2	S
			120x200	3,8	S
			150x200	4,8	S
			200x200	6,4	S
Exclusive Plus			85x220	4,2	S
			100x220	5,2	S
			120x220	6,9	S
			150x220	7,4	S
Clip			85x220	4	S
			100x220	4,3	S
Wave			85x220	2,6	S
			100x220	3,1	S
			120x220	3,7	S
			150x220	4,6	S
Twin			85x200	4	D
			100x200	4,7	D

Number of poles	Telescopic pole	Adhesive on bottom	Snap on bottom	Number of feet	Type of bag	Individual carton box
1		•		2	S	
1		•		2	S	
1		•		2	S	
1		•		2	SL	•
1		•		2	SL	•
2		•		2	SL	•
2		•		2	SL	•
1		•		2	SL	•
1		•		2	SL	•
1		•		2	SL	•
2		•		2	SL	•
2		•		2	SL	•
1		•		2	PL	•
1		•		2	PL	•
1		•		2	PL	•
2		•		2	PL	•
2		•		2	PL	•
1		•		2	PL	•
1		•		2	PL	•
1		•		2	PL	•
2		•		2	PL	•
2		•		2	PL	•
1		•		1	PL	•
1		•		1	PL	•
2		•		2	PL	•
2		•		2	PL	•
2		•		2	PL	•
1		•		2	PL	•
1		•		2	PL	•
2		•		2	PL	•
2		•		2	PL	•
1	•	•			PL	•
1	•	•			PL	•
2	•	•			PL	•
2	•	•			PL	•
1	•		•		PL	•
1	•		•		PL	•
1	•		•		PL	•
2	•		•		PL	•
2	•		•		PL	•
1		•			S	•
1		•			S	•

COMPACT

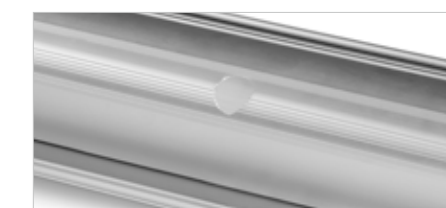
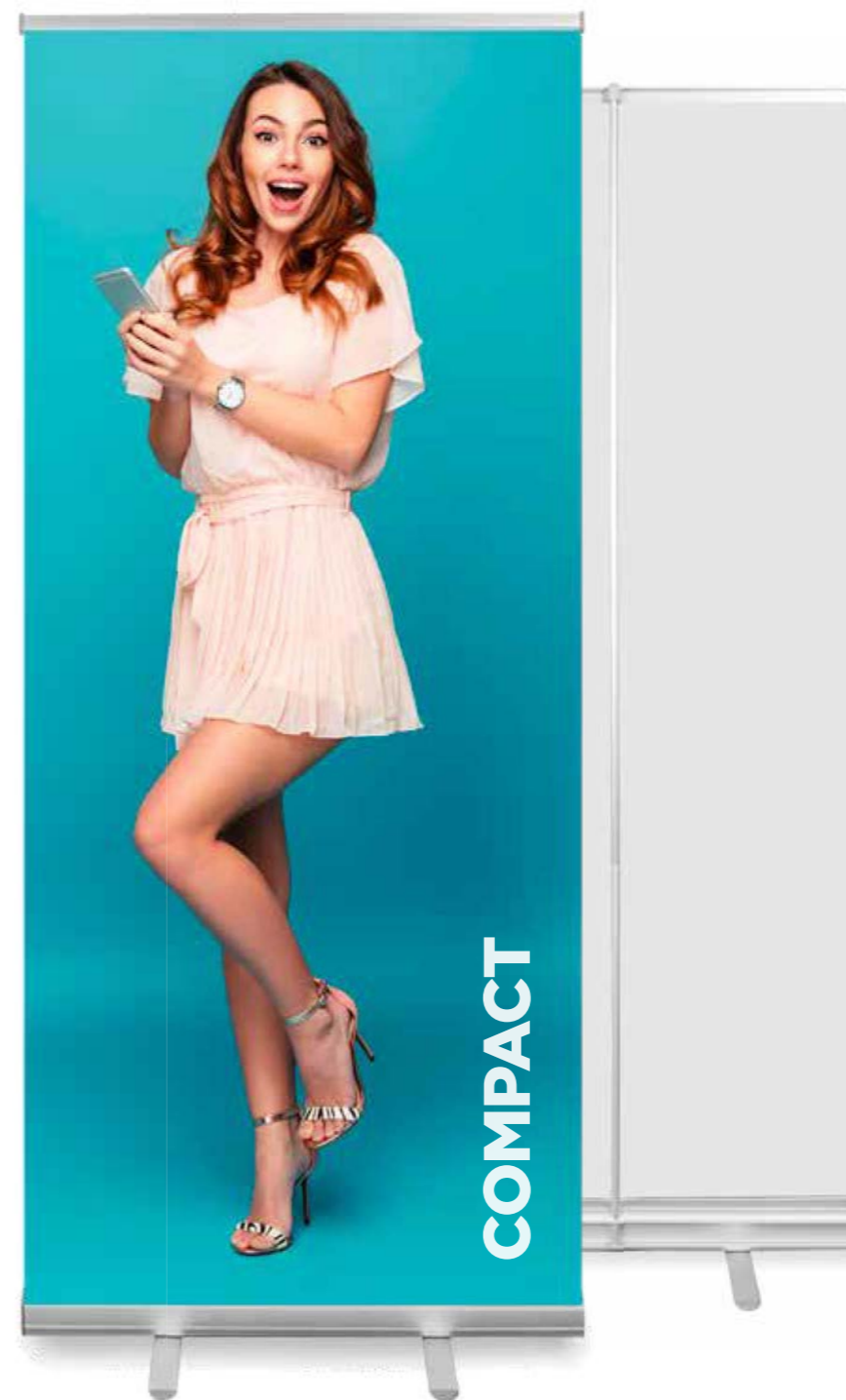

- price leader!
- small, compact and easy to carry
- cassette dimension reduced from 9,3 to 8,3 cm
- "Express Clip" top bar - quick and easy print assembly
- economy class product, valued for big adv campaigns

This set includes: Compact roll up cassette, pole, "Express Clip" top bar with 3M adhesive tape, bag with business card pocket.

- líder en precio entre los roll up
- dimensión del casete reducida de 9,3 a 8,3 cm
- pequeño, compacto, fácil de transportar
- tira „Express Clip“ - montaje instantáneo de la impresión
- producto económico, muy apreciado para grandes campañas publicitarias

El set incluye: roll up Compact cassette, mástil, tira a presión „Express Clip“, cinta adhesiva 3M, bolsa de transporte con ventana para tarjetas de visita.

- leader des prix parmi les roll-ups
- petit, compact, facile à transporter
- le diamètre de la cassette a été réduit à 8,3 cm
- profilé "Express Clip" - montage rapide des graphiques
- économique, particulièrement apprécié dans les grandes campagnes publicitaires

Le kit comprend: une cassette roll-up Compact, un mât, un profilé pince-affiche „Express Clip“, un ruban 3M, un sac de transport avec fenêtre pour une carte de visite.

80×200	5907451662762	1,5 kg
85×200	5907451660010	1,56 kg
100×200	5907451660027	1,73 kg

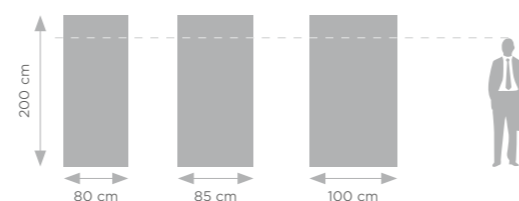

Recommended media and printing technology for this system:



STANDARD



LONG ZIP BAG

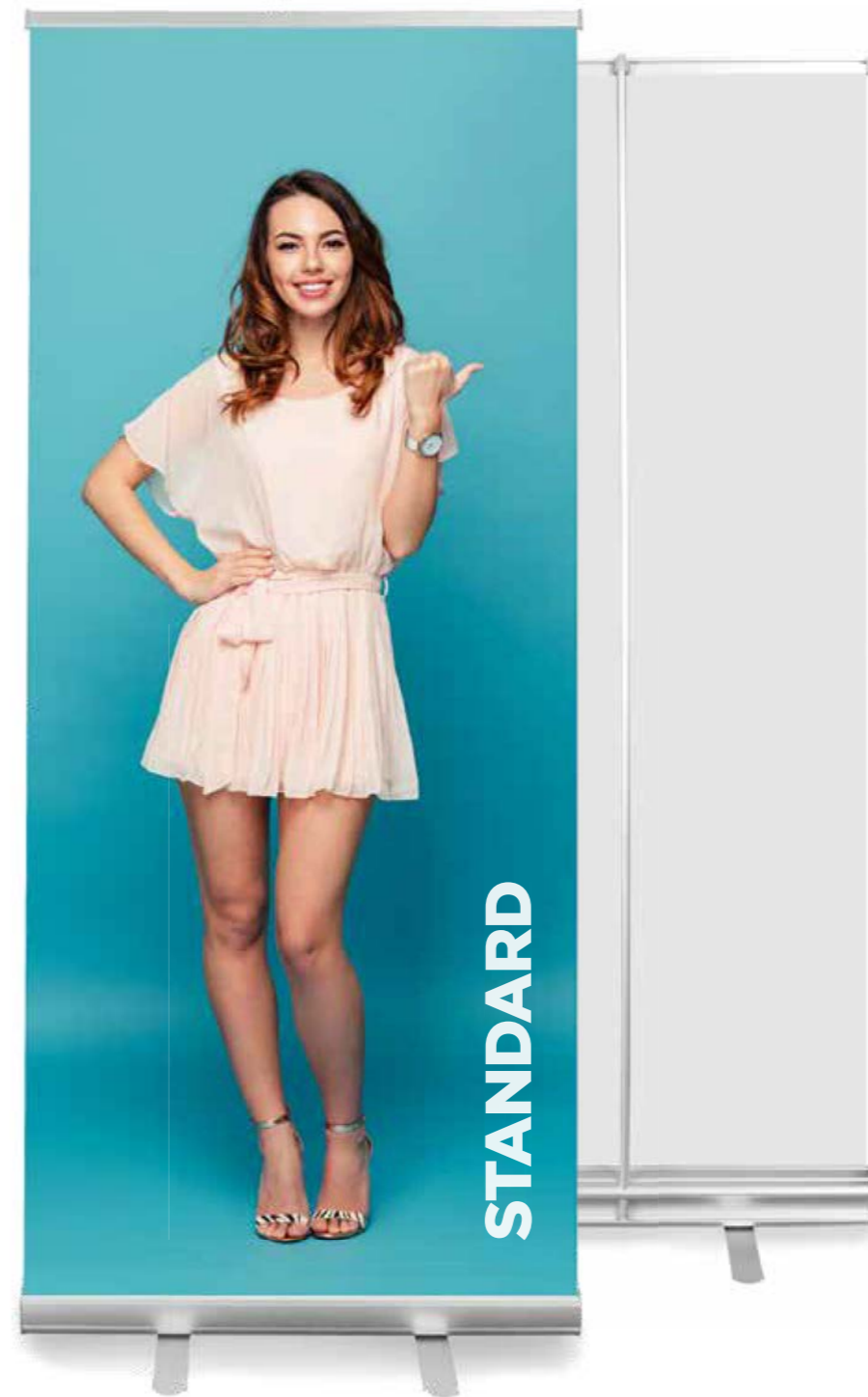

- bestseller on many markets
- stable, strong construction, 100% made of anodized aluminum
- "Express clip" top bar - quick and easy print assembly
- reinforced rear panel with the pole stabilizer
- transport bag with a long zipper

This set includes: Standard roll up cassette, pole (sizes 120×200 and 150×200 include 2 poles), "Express clip" top bar, 3M adhesive tape, bag with a business card pocket, individual box.

- superventas en muchos mercados
- construcción robusta de aluminio (100%)
- estabilizador de mástil
- tira „Express Clip“ - montaje instantáneo de la impresión
- bolsa con cierre largo

El set incluye: roll up Standard cassette, mástil (los tamaños 120×200 y 150×200 incluyen 2 mástiles), tira a presión „Express Clip“, cinta adhesiva 3M, bolsa de transporte con ventana para tarjetas de visita, caja individual.

- best-seller sur de nombreux marchés
- aluminium anodisé épais et résistant
- panneau arrière renforcé avec le stabilisateur de mât
- profilé „Express Clip“ - montage rapide des graphiques
- sac avec une longue fermeture

Le kit comprend: une cassette roll-up Standard, un mât (es tailles 120×200 et 150×200 comprennent 2 mâts), un profilé pince-affiche „Express Clip“, un ruban 3M, un sac de transport avec fenêtre pour une carte de visite, emballage en carton.

85×200	5907451660034	1,64 kg
100×200	5907451660041	2 kg
120×200	5907451660058	2,4 kg
150×200	5907451660065	3,05 kg

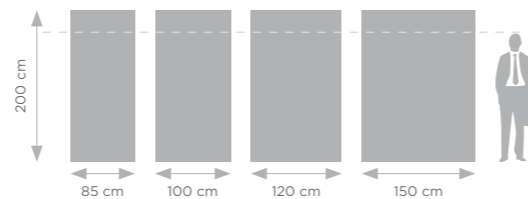

Recommended media and printing technology for this system:



STANDARD BLACK



LONG ZIP BAG

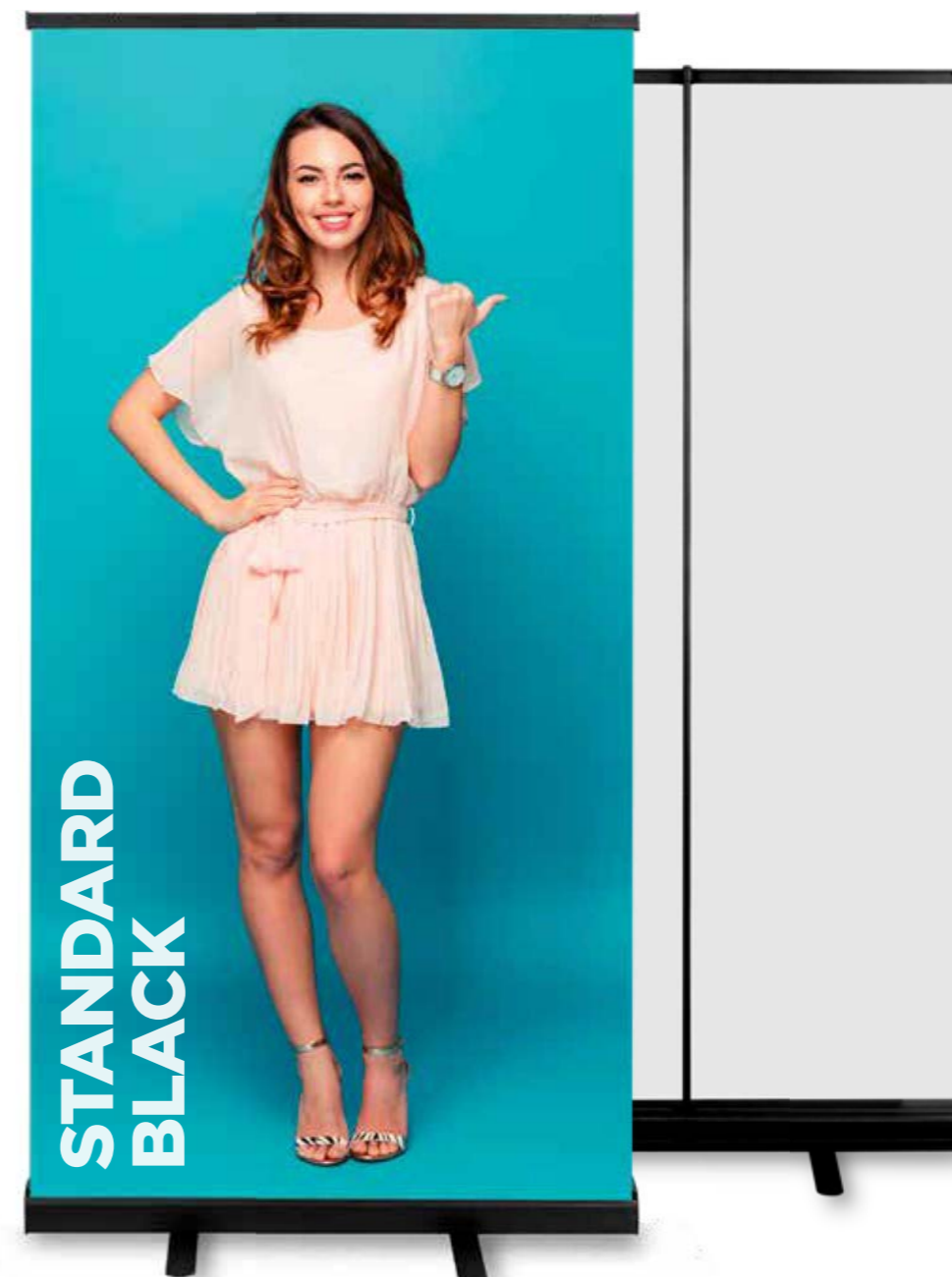

- powder painted black (mat)
- stable, strong construction, 100% made of anodized aluminum
- the pole stabilizer
- "Express clip" top bar – quick and easy print assembly
- transport bag with a long zipper

This set includes: Standard Black roll up cassette, pole, "Express clip" top bar, 3M adhesive tape, bag with a business card pocket, individual box.

- pintado con pintura en polvo negra (mate)
- construcción robusta de aluminio (100%)
- estabilizador de mástil
- tira „Express Clip“ – montaje instantáneo de la impresión
- bolsa con cierre largo

El set incluye: roll up Standard Black cassette, mástil, tira a presión „Express Clip“, cinta adhesiva 3M, bolsa de transporte con ventana para tarjetas de visita, caja individual.

- cassette noire (peinture en poudre)
- construction éprouvée et stable
- aluminium anodisé épais et résistant
- stabilisateur du mât
- profilé „Express Clip“ – montage rapide des graphiques
- sac avec une longue fermeture

Le kit comprend: une cassette roll-up Standard Black, un mât, un profilé pince-affiche „Express Clip“, un ruban 3M, un sac de transport avec fenêtre pour une carte de visite, emballage en carton.

85x200	5907451662472	1,64 kg
100x200	5907451662700	2 kg

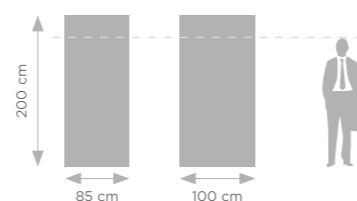

Recommended media and printing technology for this system:



STANDARD PLUS



LONG ZIP BAG

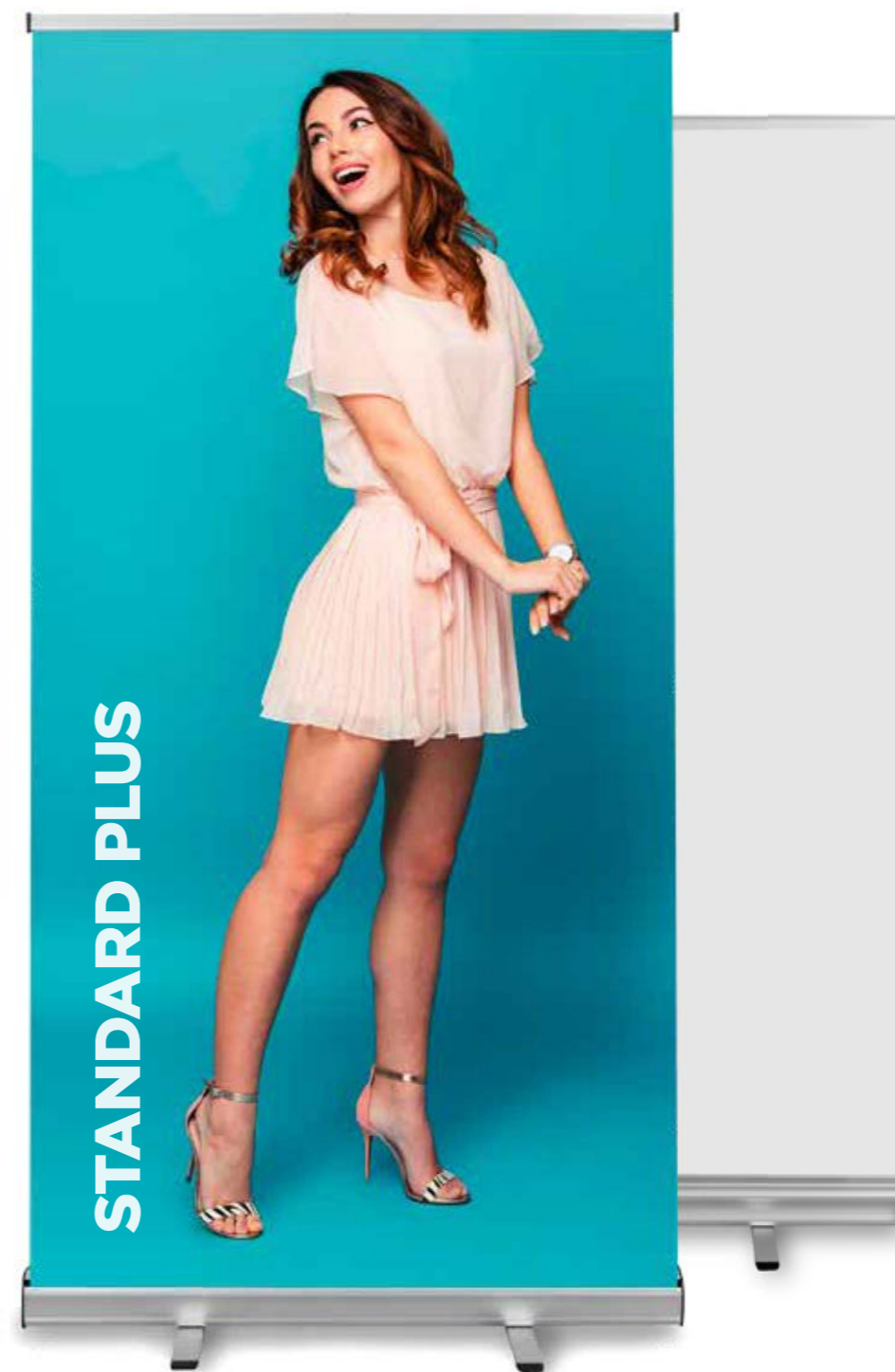

- plastic sides of the cassette, more resistant to dents
- reinforced rear panel with the pole stabilizer
- "Express Clip" top bar – quick and easy print assembly
- transport bag with a long zipper

This set includes: Standard Plus roll up cassette, pole (sizes 120×200 and 150×200 include 2 poles), "Express clip" top bar, 3M adhesive tape, bag with a business card pocket, individual box.

- lados de plástico del casete, más resistentes a las abolladuras
- estabilizador de mástil
- tira „Express Clip“ – montaje instantáneo de la impresión
- bolsa con cierre largo

El set incluye: roll up Standard Plus cassette, mástil (los tamaños 120×200 y 150×200 incluyen 2 mástiles), tira a presión „Express Clip“, cinta adhesiva 3M, bolsa de transporte con ventana para tarjetas de visita, caja individual.

- les côtés en plastique de la cassette, plus résistants aux chocs
- panneau arrière renforcé avec le stabilisateur de mât
- profilé „Express Clip“ – montage rapide des graphiques
- sac avec une longue fermeture

Le kit comprend: une cassette roll-up Standard Plus, un mât (es tailles 120×200 et 150×200 comprennent 2 mâts), un profilé pince-affiche „Express Clip“, un ruban 3M, un sac de transport avec fenêtre pour une carte de visite, emballage en carton.

85×200	5907451662427	1,6 kg
100×200	5907451662434	2 kg
120×200	5907451662724	2,4 kg
150×200	5907451662731	3,05 kg

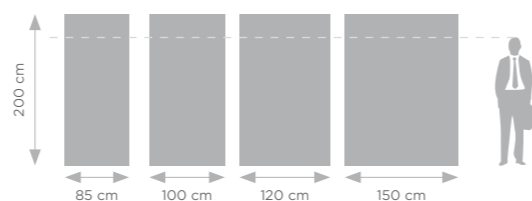

Recommended media and printing technology for this system:



Stoplight
Solvent, UV, Latex



Coated Frontlit
Solvent, UV, Latex



CLASSIC



LONG ZIP BAG

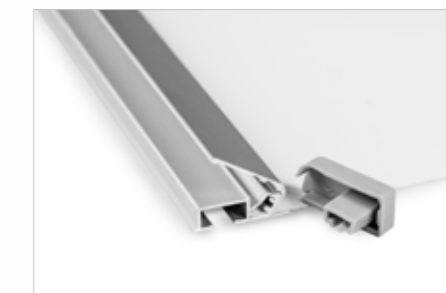
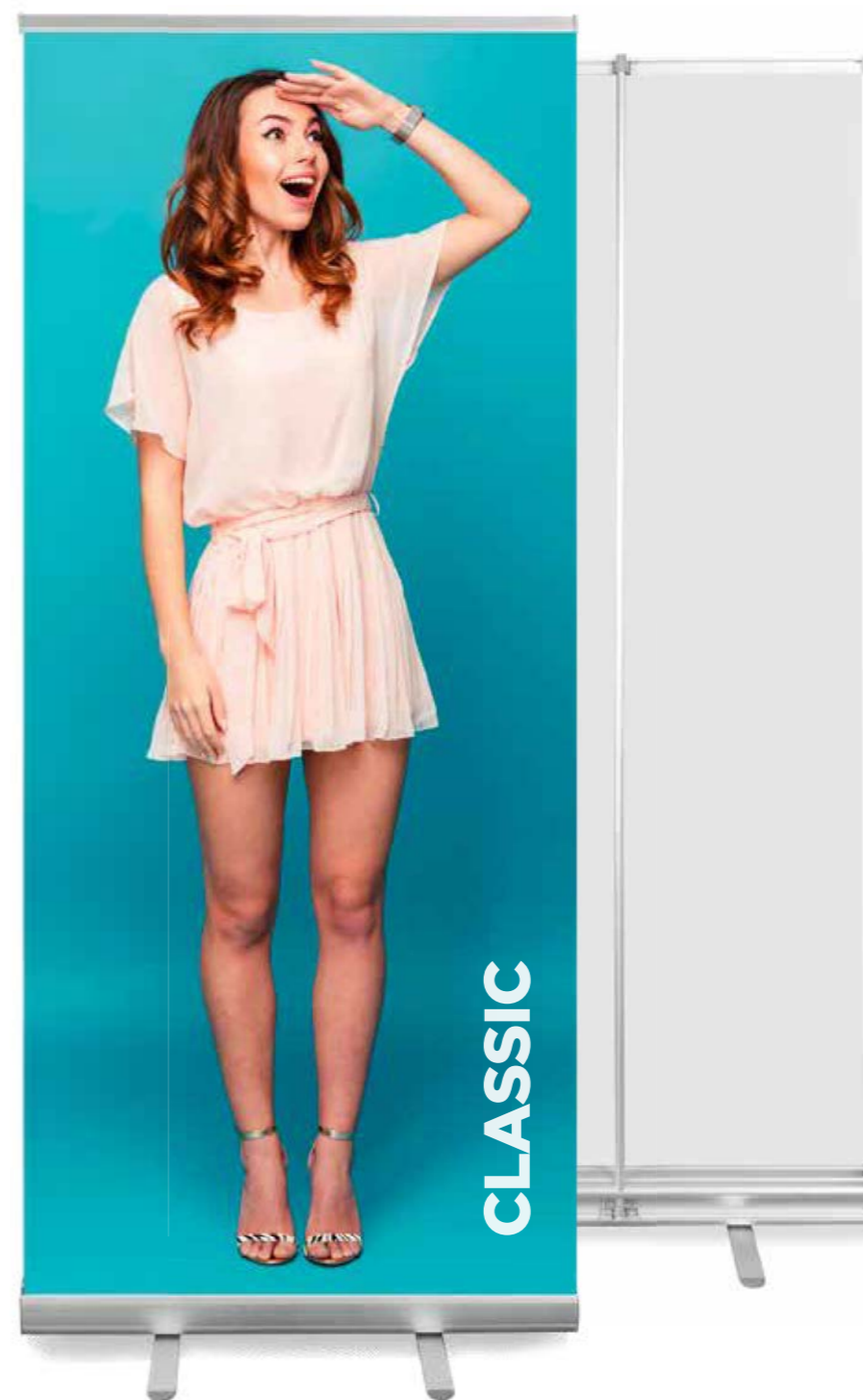

- bestseller on many markets
- reinforced rear panel with the pole stabilizer
- "Express Clip" top bar - quick and easy print assembly
- plastic foot tips
- transport bag with a long zipper

This set includes: Classic roll up cassette, pole (sizes 120x200 and 150x200 include 2 poles), "Express Clip" top bar, 3M adhesive tape, bag with a business card pocket, individual box.

- superventas en muchos mercados
- estabilizador de mástil
- tira „Express Clip“ - montaje instantáneo de la impresión
- punteras de plástico
- bolsa con cierre largo

El set incluye: roll up Classic cassette, mástil (los tamaños 120x200 y 150x200 incluyen 2 mástiles), tira a presión „Express Clip“, cinta adhesiva 3M, bolsa de transporte con ventana para tarjetas de visita, caja individual.

- best-seller sur de nombreux marchés
- panneau arrière renforcé avec le stabilisateur de mât
- profilé „Express Clip“ - montage rapide des graphiques
- embouts de pied en plastique
- sac avec une longue fermeture

Le kit comprend: une cassette roll-up Classic, un mât (es tailles 120x200 et 150x200 comprennent 2 mâts), un profilé pince-affiche „Express Clip“, un ruban 3M, un sac de transport avec fenêtre pour une carte de visite, emballage en carton.

80x200	5907451660638	1,9 kg
85x200	5907451660072	2 kg
100x200	5907451660089	2,2 kg
120x200	5907451660096	2,9 kg
150x200	5907451660102	3,4 kg

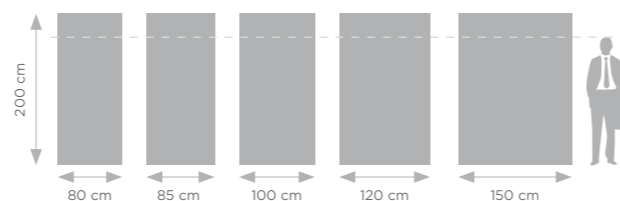

Recommended media and printing technology for this system:



BASIC

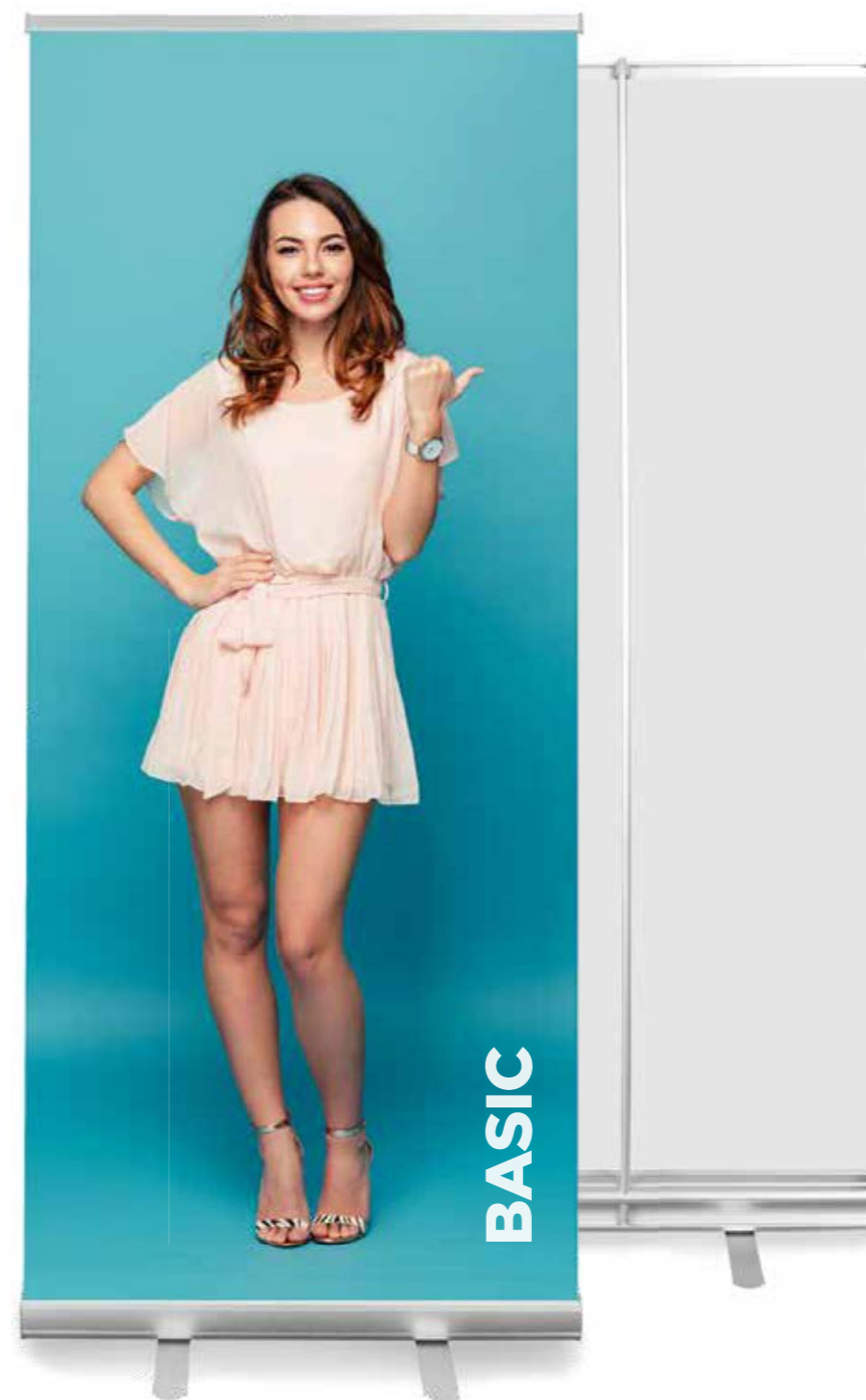

- stable, strong construction, 100% made of anodized aluminum
- the pole stabilizer
- "Express Clip" top bar - quick and easy print assembly
- padded transport bag with a long zipper and trimming

This set includes: Basic roll up cassette, pole (sizes 120x200 and 150x200 include 2 poles), "Express Clip" top bar, 3M adhesive tape, bag with a business card pocket, individual carton box.

- construcción robusta de aluminio (100%)
- estabilizador de mástil
- tira „Express Clip“ - montaje instantáneo de la impresión
- bolsa reforzada de doble capa con cierre largo

El set incluye: roll up Basic cassette, mástil (los tamaños 120x200 y 150x200 incluyen 2 mástiles), tira a presión „Express Clip“, cinta adhesiva 3M, bolsa de transporte con ventana para tarjetas de visita, caja individual.

- aluminium anodisé épais et résistant
- stabilisateur du mât
- profilé „Express Clip“ - montage rapide des graphiques
- sac renforcé avec une longue fermeture

Le kit comprend: une cassette roll-up Basic, un mât (es tailles 120x200 et 150x200 comprennent 2 mâts), un profilé pince-afiche „Express Clip“, un ruban 3M, un sac de transport avec fenêtre pour une carte de visite, emballage en carton.

80x200	5907451668191	1,9 kg
85x200	5907451668061	2,1 kg
100x200	5907451668078	2,5 kg
120x200	5907451668085	3 kg
150x200	5907451668092	3,7 kg

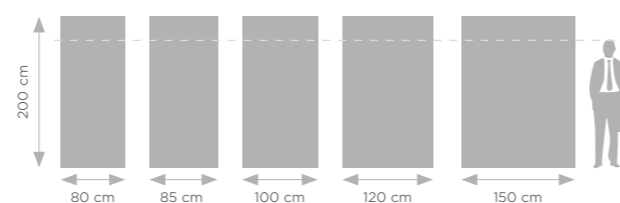

Recommended media and printing technology for this system:



PREMIUM



LONG ZIP BAG

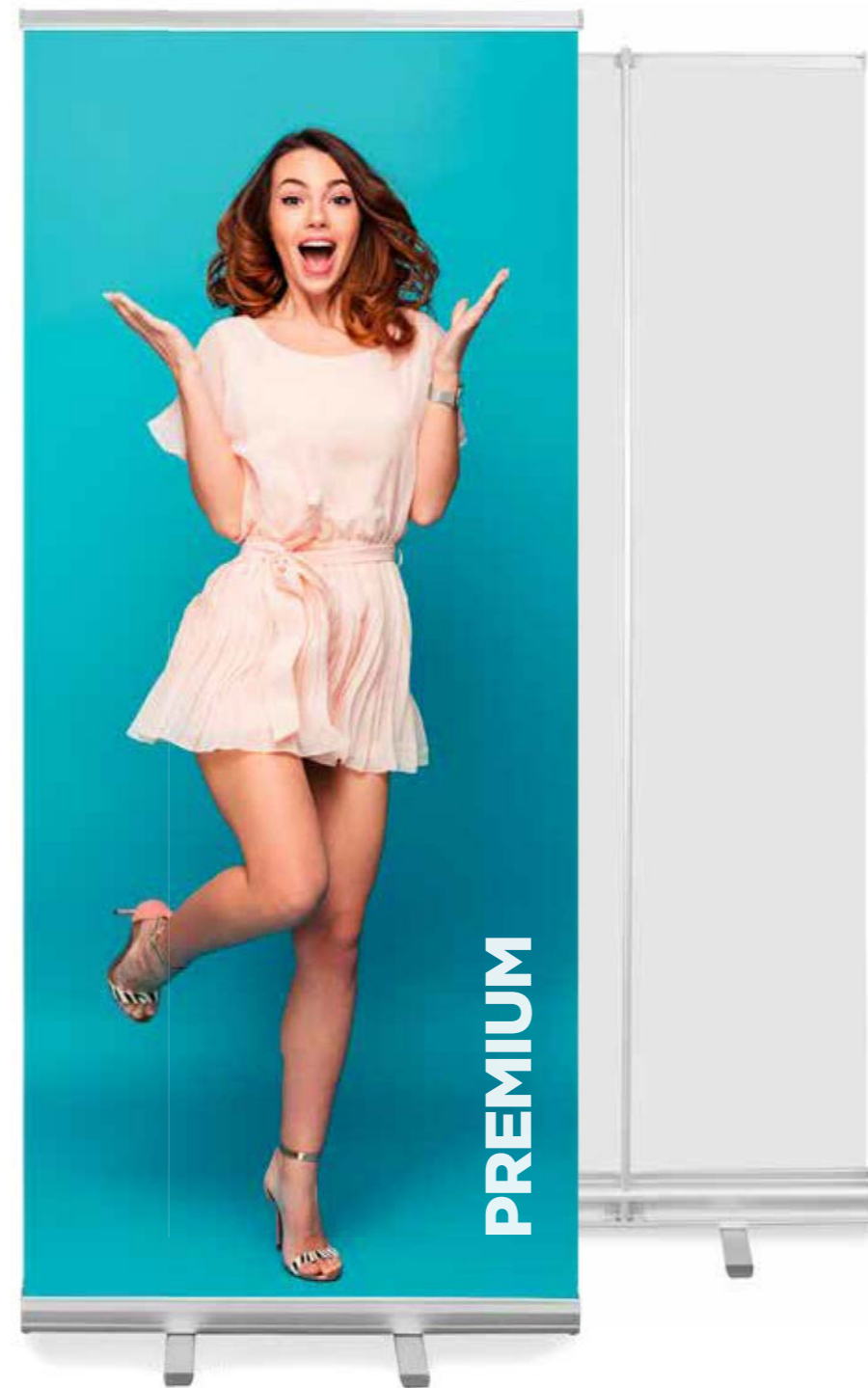

- solid, heavy construction
- reinforced rear panel with the pole stabilizer
- "Express Clip" top bar - quick and easy print assembly
- foot tips and side walls in dark elegant colour
- padded transport bag with a long zipper and trimming

This set includes: Premium roll up cassette, pole (sizes 120×200 and 150×200 include 2 poles), „Express Clip“ top bar, 3M adhesive tape, bag with a business card pocket, individual carton box.

- construcción sólida y pesada
- estabilizador de mástil
- tira „Express Clip“ para un montaje instantáneo de la impresión
- puntas y paredes laterales en un elegante color oscuro
- bolsa reforzada de doble capa con cierre largo

El set incluye: roll up Premium cassette, mástil (los tamaños 120×200 y 150×200 incluyen 2 mástiles), tira a presión „Express Clip“, cinta adhesiva 3M, bolsa de transporte con ventana para tarjetas de visita, caja individual.

- aluminium anodisé épais et résistant
- panneau arrière renforcé avec le stabilisateur de mât
- profilé „Express Clip“ - montage rapide des graphiques
- pointes de pieds et parois latérales dans une couleur sombre et élégante
- sac renforcé avec une longue fermeture

Le kit comprend: cassette roll-up Premium, un mât (es tailles 120×200 et 150×200 comprennent 2 mâts), un profilé pince-afiche „Express Clip“, un ruban 3M, un sac de transport avec fenêtre pour une carte de visite, emballage en carton.

80×200	5907451668009	2 kg
85×200	5907451660119	2,2 kg
100×200	5907451660126	2,7 kg
120×200	5907451660133	3,5 kg
150×200	5907451660140	4 kg

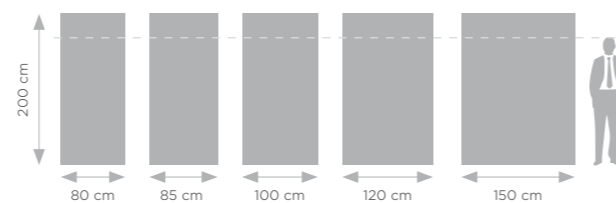

Recommended media and printing technology for this system:



PRO



LONG ZIP BAG



- 200x200 cm size available
- the thickest aluminium profile among standard cassettes
- heavy and very stable product
- "Express Clip" top bar - quick and easy print assembly
- padded transport bag with a long zipper and trimming

This set includes: Pro roll up cassette, pole (sizes 120x200, 150x200 and 200x200 include 2 poles), "Express Clip" top bar, 3M adhesive tape, bag with a business card pocket, individual box.

- disponible en tamaño 200x200 cm
- el perfil de aluminio más grueso de la oferta
- elevado peso y estabilidad del sistema
- tira „Express Clip“ para un montaje instantáneo de la impresión
- bolsa reforzada de doble capa con un cierre largo

El set incluye: roll up Pro cassette, mástil (los tamaños 120x200, 150x200, 200x200 incluyen 2 mástil), tira a presión „Express Clip“, cinta adhesiva 3M, bolsa de transporte con ventana para tarjetas de visita, caja individual.

- disponible en taille 200x200 cm
- le profilé aluminium le plus épais disponible dans l'offre
- poids élevé et grande stabilité du système
- profilé „Express Clip“ - montage rapide des graphiques
- sac renforcé avec une longue fermeture

Le kit comprend: cassette roll-up Pro, un mât (es tailles 120x200, 150x200, 200x200 comprennent 2 mâts), un profilé pince-affiche „Express Clip“, un ruban 3M, un sac de transport avec fenêtre pour une carte de visite, emballage en carton.

85x200	5907451660584	2,7 kg
100x200	5907451660591	3,1 kg
120x200	5907451660607	3,7 kg
150x200	5907451660614	4,7 kg
200x200	5907451660621	6,2 kg

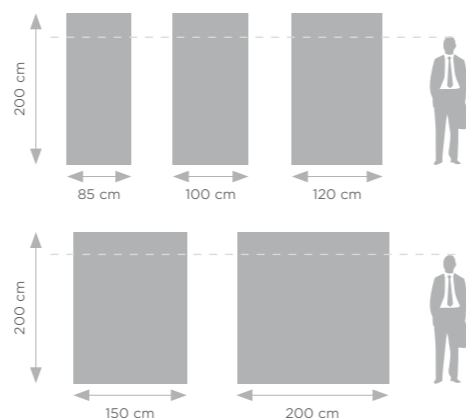

Recommended media and printing technology for this system:

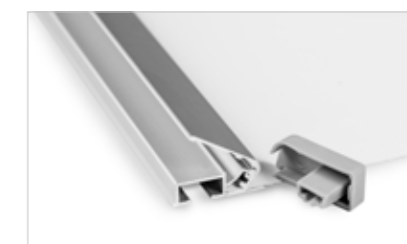
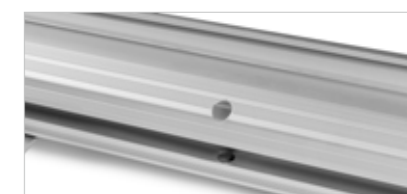
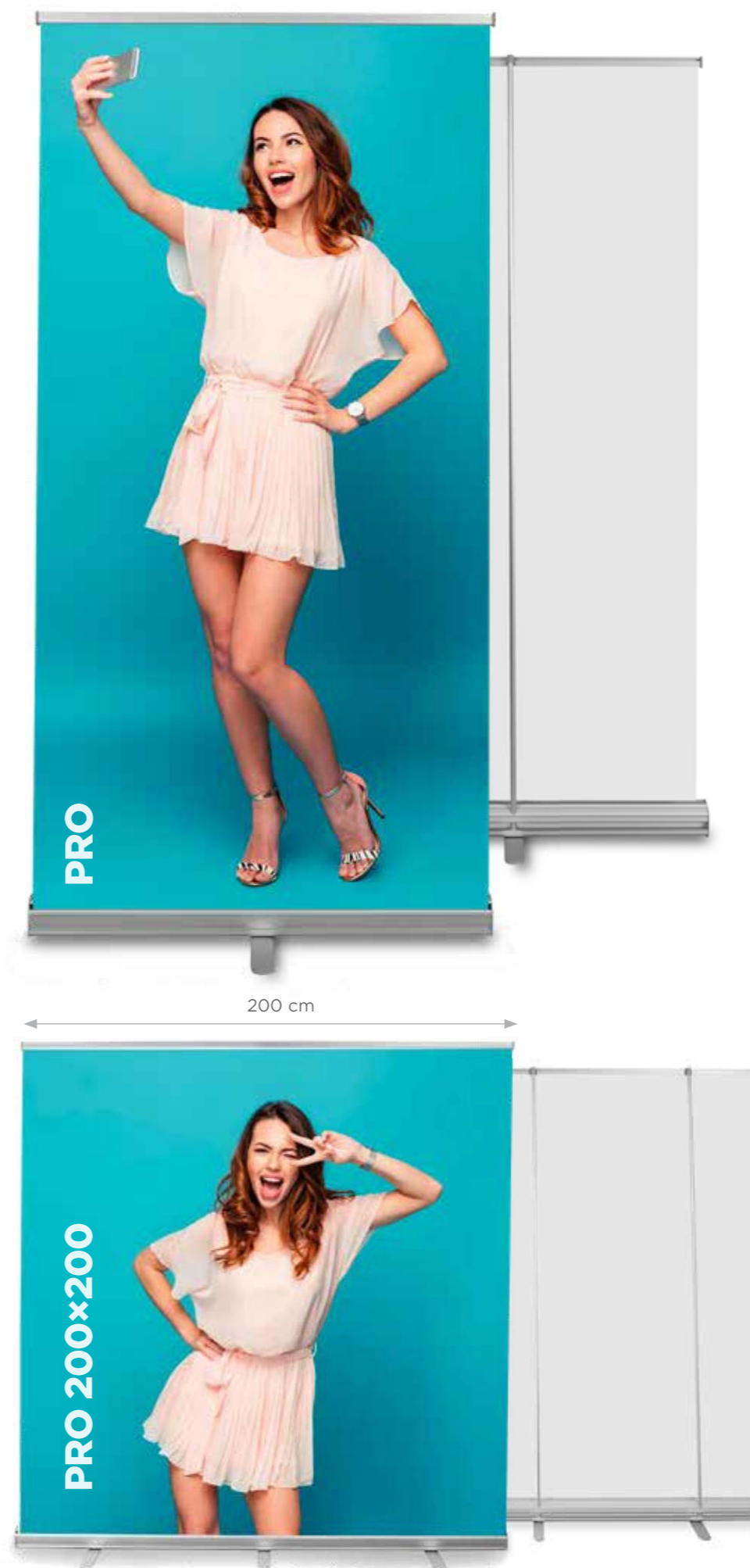

EXCLUSIVE

PREMIUM LINE

BEST SELLER

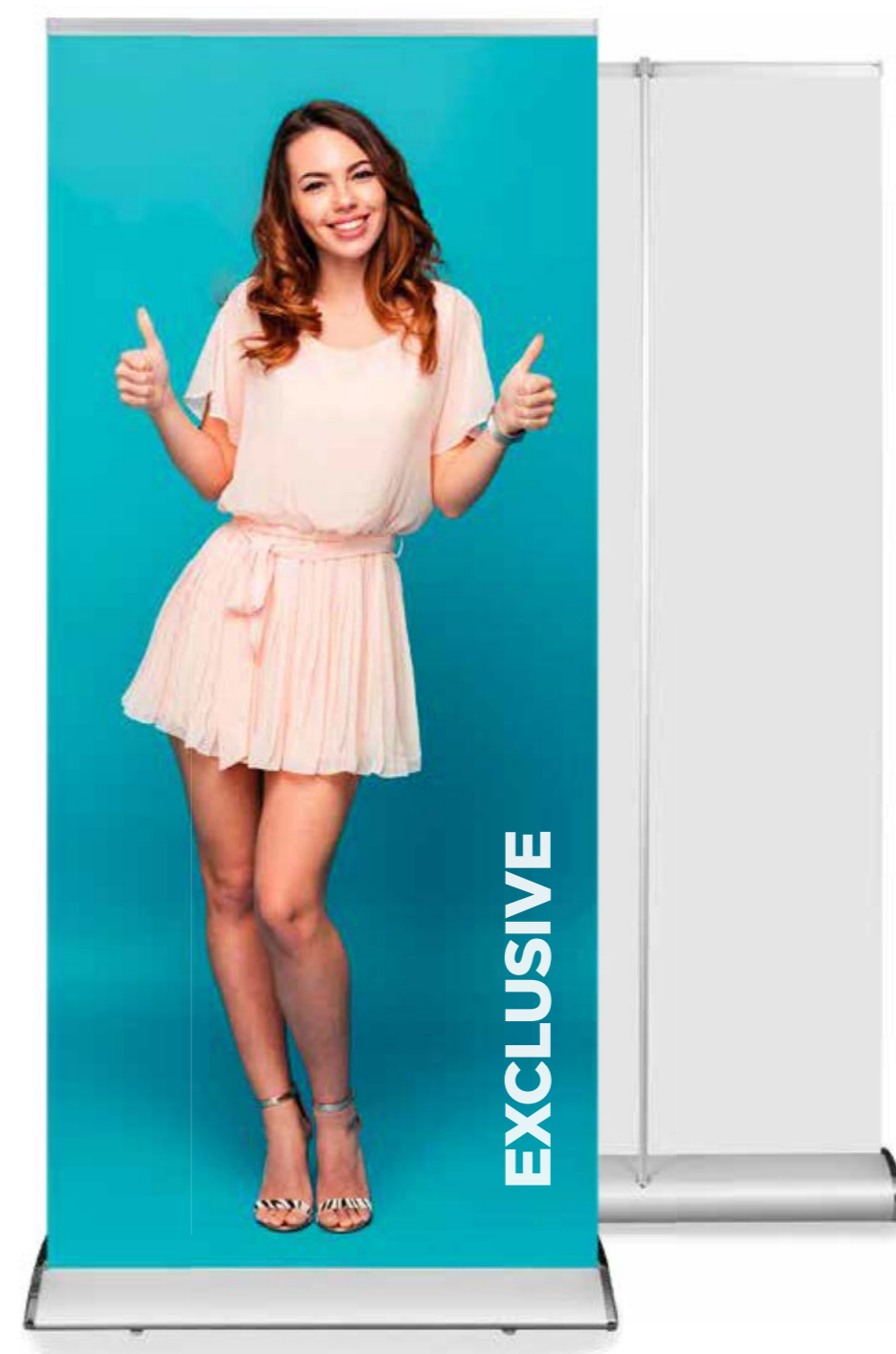

- elegant appearance
- 200x200 cm size available
- heavy and very stable product
- "Express Clip" top bar – quick and easy print assembly
- elegant carrying bag with a long zipper

This set includes: Exclusive roll up cassette, pole (sizes 120x200, 150x200 and 200x200 include 2 poles), "Express Clip" top bar, 3M adhesive tape, bag with a business card pocket, individual box.

- aspecto elegante y diseño único
- disponible en tamaño 200x200 cm
- la construcción más estable entre los roll up
- tira „Express Clip“ para un montaje instantáneo de la impresión
- bolsa elegante con cierre largo

El set incluye: roll up Exclusive cassette, mástil (los tamaños 120x200, 150x200, 200x200 incluyen 2 mástil), tira a presión „Express Clip“, cinta adhesiva 3M, bolsa de transporte con ventana para tarjetas de visita, caja individual.

- aspect élégant et design unique
- disponible en taille 200x200 cm
- la construction la plus stable parmi les bannières roll-up
- profilé „Express Clip“ - montage rapide des graphiques
- sac avec une longue fermeture

Le kit comprend: une cassette roll-up Exclusive, un mât (es tailles 120x200, 150x200, 200x200 comprennent 2 mâts), un profilé pince-affiche „Express Clip“, un ruban 3M, un sac de transport avec fenêtre pour une carte de visite, emballage en carton.

Size	Barcode	Weight
85x200	5907451660492	2,7 kg
100x200	5907451660508	3,2 kg
120x200	5907451660515	3,8 kg
150x200	5907451660522	4,8 kg
200x200	5907451660539	6,4 kg

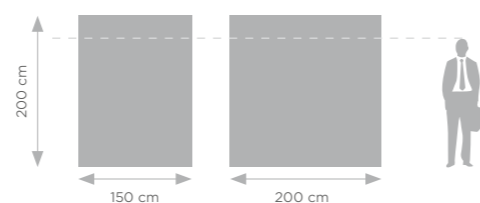
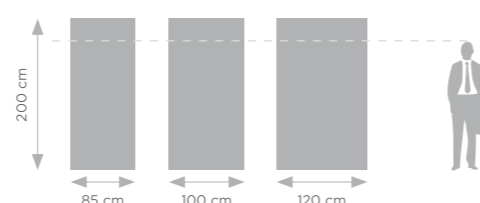

Recommended media and printing technology for this system:



EXCLUSIVE BLACK

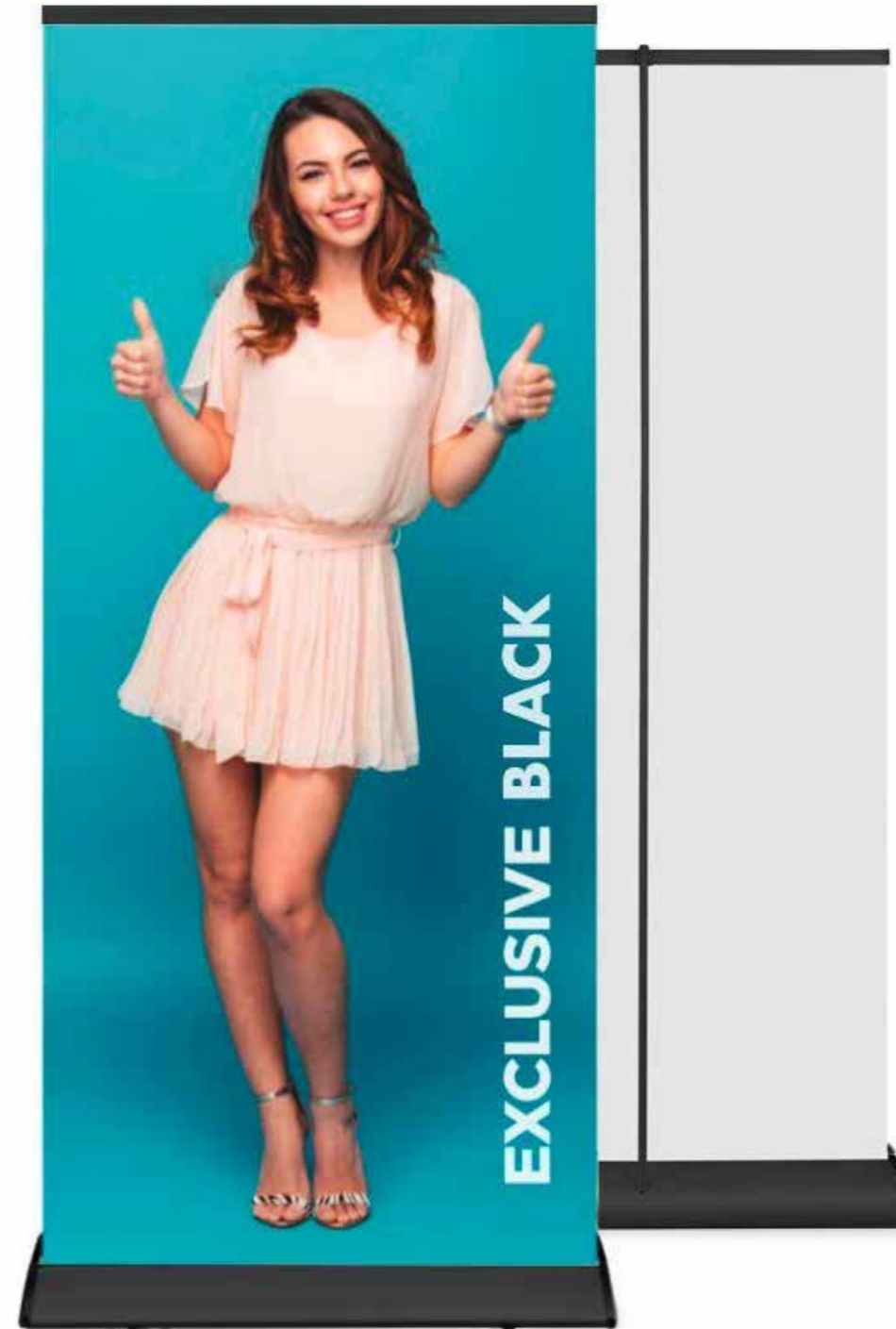

- elegant appearance
- 200x200 cm size available
- heavy and very stable product
- "Express Clip" top bar - quick and easy print assembly
- elegant carrying bag with a long zipper

This set includes: Exclusive Black roll up cassette, pole (120x200, 150x200 and 200x200 include 2 poles), "Express Clip" top bar, 3M adhesive tape, bag with a business card pocket, individual box.

- aspecto elegante y diseño único
- disponible en tamaño 200x200 cm
- la construcción más estable entre los roll up
- tira „Express Clip“ para un montaje instantáneo de la impresión
- bolsa elegante con cierre largo

El set incluye: roll up Exclusive Black cassette, mástil (los tamaños 120x200, 150x200, 200x200 incluyen 2 mástil), tira a presión „Express Clip“, cinta adhesiva 3M, bolsa de transporte con ventana para tarjetas de visita, caja individual.

- aspect elegant et design unique
- disponible en taille 200x200 cm
- la construction la plus stable parmi les bannières roll-up
- profilé „Express Clip“ - montage rapide des graphiques
- sac avec une longue fermeture

Le kit comprend: une cassette roll-up Exclusive Black, un mat (es tailles 120x200, 150x200, 200x200 comprennent 2 mâts), un profilé pince-affiche „Express Clip“, un ruban 3M, un sac de transport avec fenêtre pour une carte de visite, emballage en carton.

85x200	5907451666982	2,7 kg
100x200	5907451666975	3,2 kg
120x200	5904423600692	3,8 kg
150x200	5904423600708	4,8 kg
200x200	5904423600715	6,4 kg

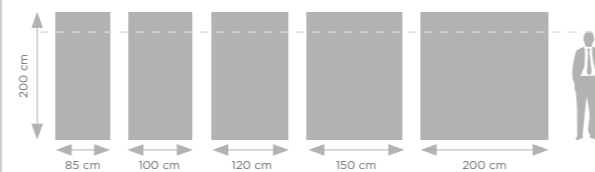

Recommended media and printing technology for this system:



EXCLUSIVE PLUS

NEW!

PREMIUM LINE

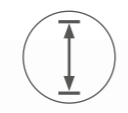

TELESCOPIC POLE

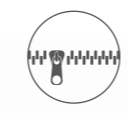

LONG ZIP BAG

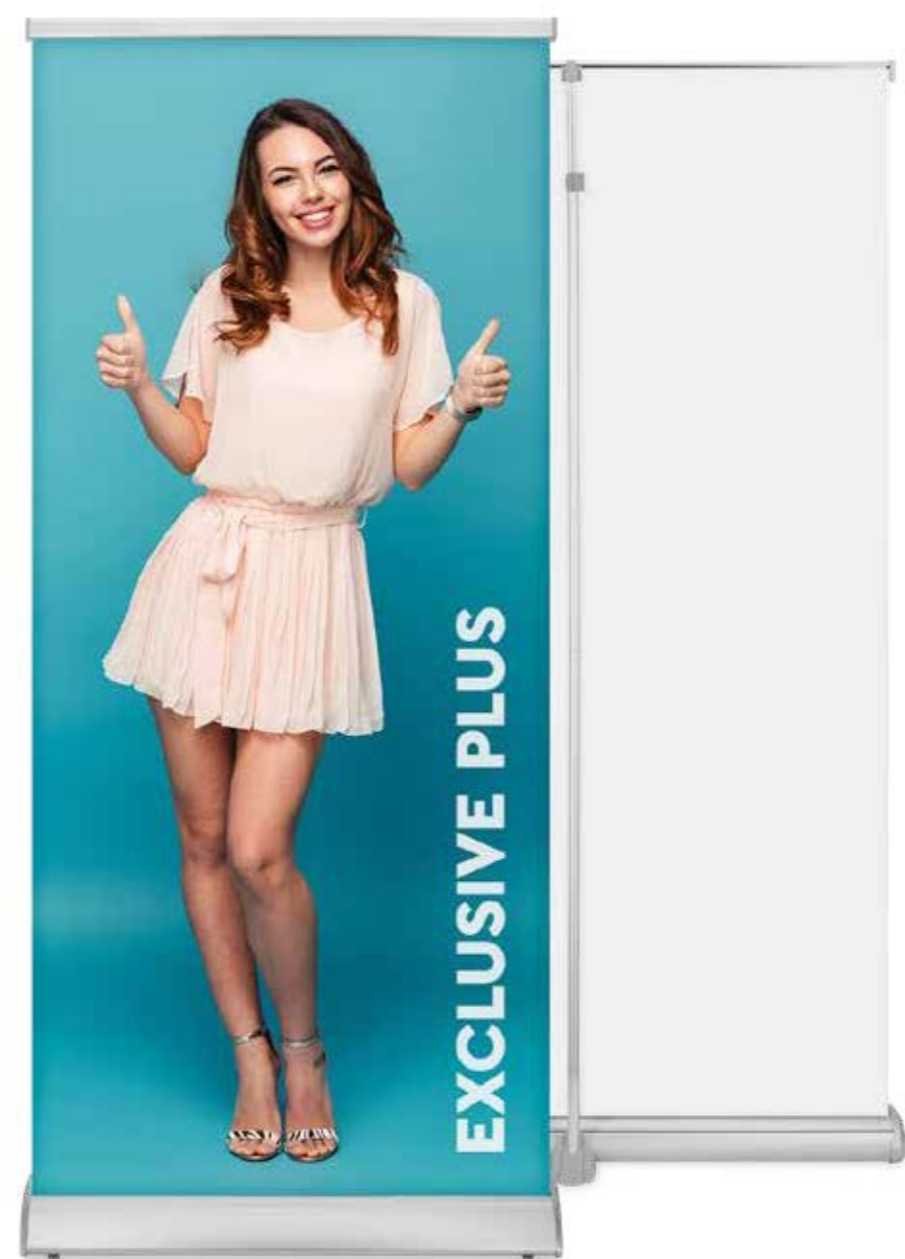

max 220 cm

- elegant appearance and unique design
- telescopic pole (up to 220 cm)
- exceptionally heavy, stable construction
- "Express Clip" top bar - very quick printout installation
- elegant carrying bag with a long zipper

The set contains: Exclusive Plus cassette, pole (sizes 120x220, 150x220 include 2 poles), "Express Clip" top bar, 3M adhesive tape, bag with a business card pocket, individual carton box.

- aspecto elegante y diseño único
- mástil telescópico (hasta 220 cm)
- estructura excepcionalmente pesada y estable
- barra "Express Clip": montaje instantáneo de la impresión
- bolsa con cremallera larga

El set incluye: roll up Exclusive Plus cassette, mástil (los tamaños 120x220, 150x220 incluyen 2 mástiles), tira a presión "Express Clip", cinta adhesiva 3M, bolsa de transporte con ventana para tarjetas de visita, caja de cartón individual.

- aspect élégant et design unique
- mât télescopique (jusqu'à 220 cm)
- structure extrêmement lourde et stable
- barre "Express Clip" - montage instantané de l'impression
- sac avec une longue fermeture

Le kit comprend: une cassette roll-up Exclusive Plus, un mât (es tailles 120x220, 150x220 comprennent 2 mâts), un profilé pince-affiche "Express Clip", un ruban 3M, un sac de transport avec fenêtre pour une carte de visite, emballage en carton.

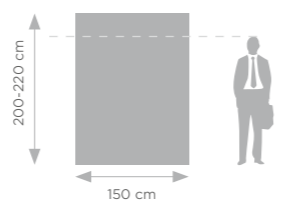
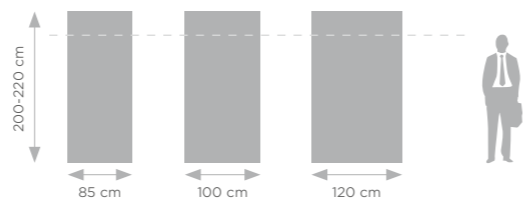

85x220	5904423600753	4,2 kg
100x220	5904423600760	5,2 kg
120x220	5904423600777	6,9 kg
150x220	5904423600784	7,4 kg



Recommended media and printing technology for this system:



WAVE

- 
GRAPHICS EXCHANGE SYSTEM
- 
TELESCOPIC POLE
- 
LONG ZIP BAG

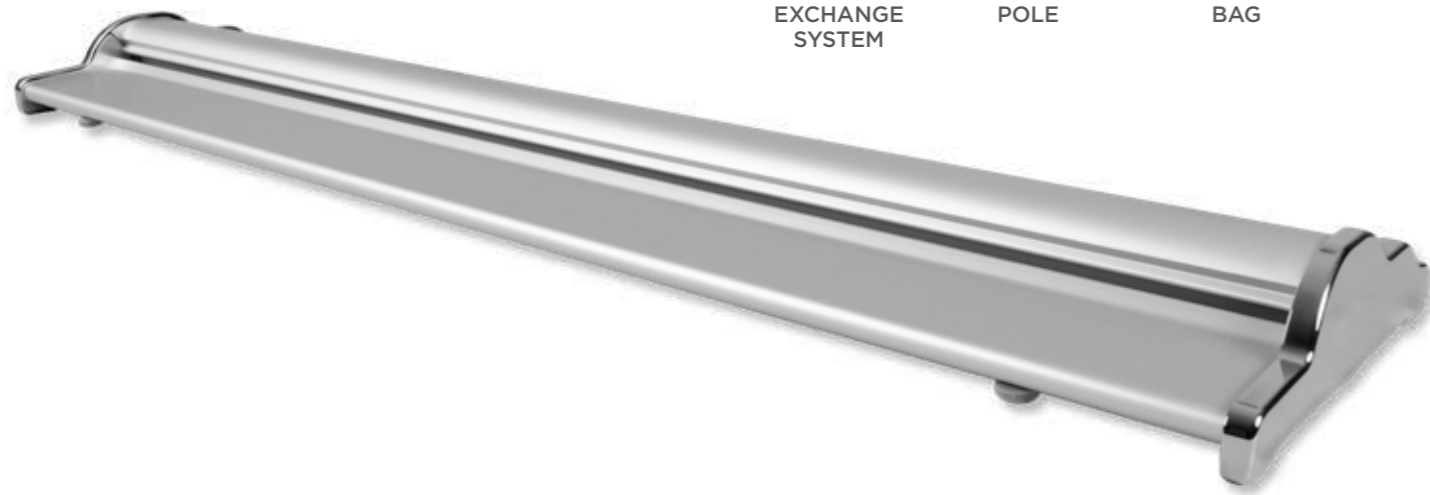

- adjustable pole (up to 220 cm)
- graphics exchange system
- elegant, stylish look
- "Express Clip" top bar - quick and easy print assembly
- padded bag with a long zipper

This set includes: WAVE roll up cassette, pole (sizes 120×200 and 150×200 include 2 poles), "Express Clip" top bar, padded bag with a business card pocket, individual box.

- mástil telescópico de hasta 220 cm
- sistema de intercambio gráfico
- diseño elegante e inusual
- tira „Express Clip“ para un montaje instantáneo de la impresión
- bolsa de doble capa con cierre largo

El set incluye: roll up Wave cassette, mástil (los tamanos 120×200 y 150×200 incluyen 2 mastil), tira a presión „Express Clip“, bolsa de transporte con ventana para tarjetas de visita, caja individual.

- mât réglable jusqu'à 220 cm
- système permettant d'échanger les images
- aspect élégant et insolite
- profilé „Express Clip“ - montage rapide des graphiques
- sac deux épaisseurs avec une longue fermeture

Le kit comprend: une cassette roll-up Wave, un mât (es tailles 120×200 et 150×200 comprennent 2 mats), un profilé pince-affiche „Express Clip“, un sac de transport avec fenêtre pour une carte de visite, emballage en carton.

		
85×200	5907451665831	2,6 kg
100×200	5907451665848	3,1 kg
120×200	5907451665855	3,7 kg
150×200	5907451665862	4,6 kg

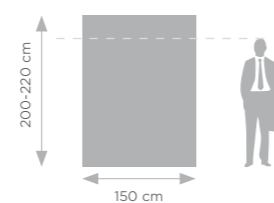
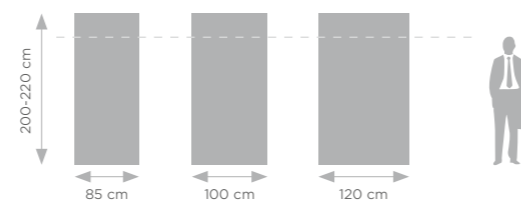

Recommended media and printing technology for this system:



CLIP

NEW!

PREMIUM LINE



GRAPHICS EXCHANGE SYSTEM

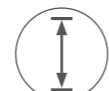

TELESCOPIC POLE



LONG ZIP BAG



max 220 cm

- telescopic pole up to 220 cm
- graphics exchange system
- very stable construction
- "Express Clip" top bar - quick and easy print assembly
- inner pocket in the bag for mast and batten
- padded bag with a long zipper

The set includes: Clip roll up cassette, pole, "Express clip" top bar, transport bag with business card pocket, individual box.

- mástil telescópico de hasta 220 cm
- sistema de intercambio gráfico
- construcción muy estable
- tira "Express Clip" para un montaje instantáneo de la impresión
- bolsillo interior en la bolsa para el mástil y los cables
- bolsa de doble capa con cierre largo

El set incluye: roll up Clip cassette, mástil, tira a presión "Express Clip", bolsa de transporte con ventana para tarjetas de visita, caja individual.

- mât réglable jusqu'à 220 cm
- système d'échange de graphiques
- construction très stable
- profilé „Express Clip” - montage rapide des graphiques
- poche intérieure dans le sac pour le mât et la latte
- sac deux épaisseurs avec une longue fermeture

Le kit comprend: une cassette roll-up Clip, un mât, un profilé pince-affiche "Express Clip", un sac de transport, emballage en carton.

85x200	5907451668498	4 kg
100x200	5907451668504	4,3 kg

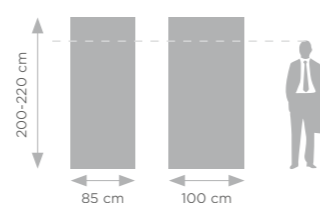

Recommended media and printing technology for this system:



TWIN



- two-sided roll up model: two separate printouts
- heavy and very stable product
- "Express Clip" top bar – quick and easy print assembly

This set includes: Twin roll up cassette, pole, "Express Clip" top bar, 3M adhesive tape, bag with a business card pocket, individual box.

- construcción estable
- modelo de doble cara = dos impresiones separadas
- tira „Express Clip“ para un montaje instantáneo de la impresión

El set incluye: roll up Twin cassette, mástil, tira a presión „Express Clip“, cinta adhesiva 3M, bolsa de transporte con ventana para tarjetas de visita, caja individual.

- présentation des visuels sur les deux faces
- structure stable, cassette très lourde
- profilé „Express Clip“ – montage rapide des graphiques

Le kit comprend: une cassette roll-up Twin, un mât, un profilé pince-affiche „Express Clip“, un ruban 3M, un sac de transport avec fenêtre pour une carte de visite, emballage en carton.

		
85x200	5907451660645	4 kg
100x200	5907451660652	4,7 kg

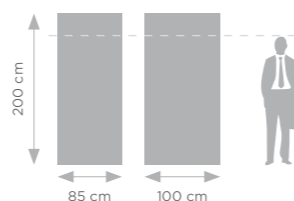



Recommended media and printing technology for this system:



ROLL UP ACCESSORIES

ROLL UP LIGHT

 If you need to illuminate the printout, our lamps, mounted directly on the roll-up pole, will be a perfect solution. Two variants are available: in LED and halogen technology. They will definitely improve the aesthetics of graphics.

 Si necesita iluminar la impresión, nuestras lámparas, montadas directamente en el poste roll up, serán la solución perfecta. Hay dos variantes disponibles: con tecnología LED y halógena. Sin duda, mejorarán la estética de los gráficos.

 Si vous avez besoin d'éclairer votre impression, nos lampes, montées directement sur le mât des bannières roll-up, sont idéales. Deux variantes sont disponibles: LED et halogène. Elles amélioreront sans aucun doute l'esthétique et la perception du graphisme.

HALOGEN



 5907451669945  0,3 kg

LED

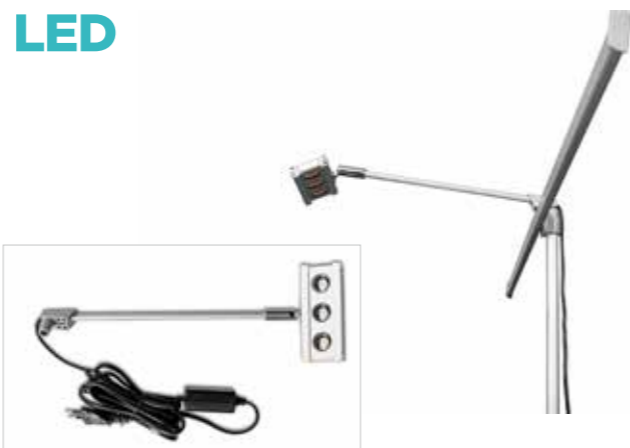



 5907451669938  0,3 kg

BLOCKOUTS



-  high class materials
- materials do not let light through
- opaque surface prevents unwanted reflexes
- high density and thickness

-  materiales de alta calidad
- los materiales no dejan pasar la luz
- la superficie opaca evita los reflejos no deseados
- alta densidad y grosor

-  matériaux de haute qualité
- les matériaux ne laissent pas passer la lumière
- la surface opaque empêche les reflets indésirables
- densité et épaisseur élevées

	Width (m)	
Standard 330 g	0,914	5907451668610
Standard 330 g	1,07	5907451669402
Standard 330 g	1,27	5907451668528
Standard 330 g	1,52	5907451667194
Premium 330 g	0,914	5907451663219
Premium 330 g	1,07	5907451663226
Premium 330 g	1,27	5907451663233
Premium 330 g	1,52	5907451663240
Premium B1 FR (flame retardant) 330 g	0,914	5907451667316
Premium B1 FR (flame retardant) 330 g	1,07	5907451667323
Premium B1 FR (flame retardant) 330 g	1,27	5907451667293
PVC Free 260 g	0,914	5907451663257
PVC Free 260 g	1,07	5907451667309



STANDS

X-BANNER COMPACT

- low cost system
- simple handling
- ultralight construction made of fiberglass

This set includes: complete X-banner system and a simple bag.

- coste del sistema muy bajo
- construcción ultraligera
- montaje sencillo

El set contiene: sistema X-banner Compact y bolsa de poliéster.

- coût du système très faible
- construction ultralégère en fibre de verre
- montage simple

Le kit comprend: un système X-banner Compact, un sac en polyester.

60x160	5907451660195	0,6 kg
80x180	5907451660201	0,8 kg

Recommended media and printing technology for this system:

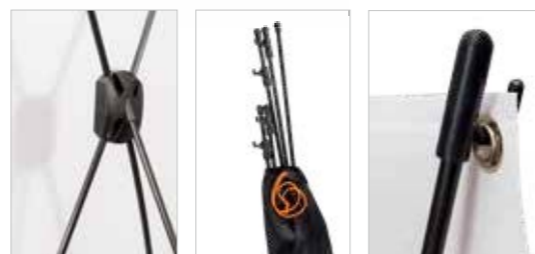
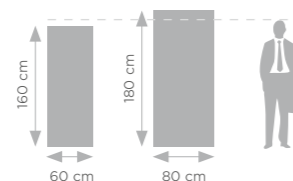

X-BANNER STANDARD

- improved model of X-banner system
- construction made of metal painted in black and fiberglass
- high quality
- ultralight, easy to carry and use

This set includes: complete X-banner system and a bag (the print-out also can fit in).

- modelo mejorado del sistema X-banner
- estructura fabricada en metal pintado en negro y fibra de vidrio
- alta calidad
- ultraligero, fácil de transportar y utilizar

El set incluye: sistema X-banner Standard y bolsa de transporte.

- modèle amélioré du système de bannière X (effectué en métal thermolaqué noir et il possède des bras flexibles en fibre de verre)
- construction ultralégère
- montage simple
- haute qualité des produits

Le kit comprend: un système X-banner Standard, un sac de transport (l'impression peut également tenir dans).

60x160	5907451660218	1,3 kg
80x180	5907451660225	1,4 kg
120x210	5907451660232	1,7 kg

Recommended media and printing technology for this system:

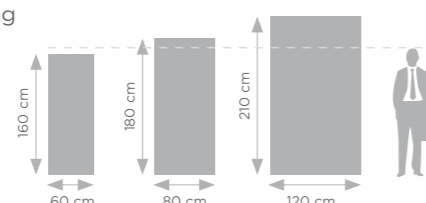

L-BANNER

- low cost system
- simple handling
- ultralight
- single and double sided version available

These sets include: complete L-banner system and a simple bag (the printout also can fit in).

- coste del sistema muy bajo
- construcción ultraligera
- versión de una y dos caras disponible

El set contiene: sistema L-banner y bolsa (en la que también cabe la impresión).

- coût du système très faible
- construction ultralégère
- montage simple
- version simple et double face disponible

Le kit comprend: un système L-banner, un sac de transport (l'impression peut également tenir dans).

Recommended media and printing technology for this systems:



L-BANNER PREMIUM



85x210	5907451660669	1,4 kg

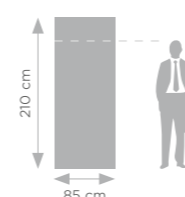

L-BANNER PREMIUM TWIN



85x210	5907451660683	2,40 kg
100x210	5907451660690	2,70 kg

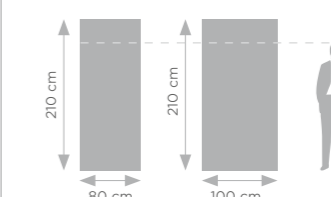

ATLANTIS EXPO

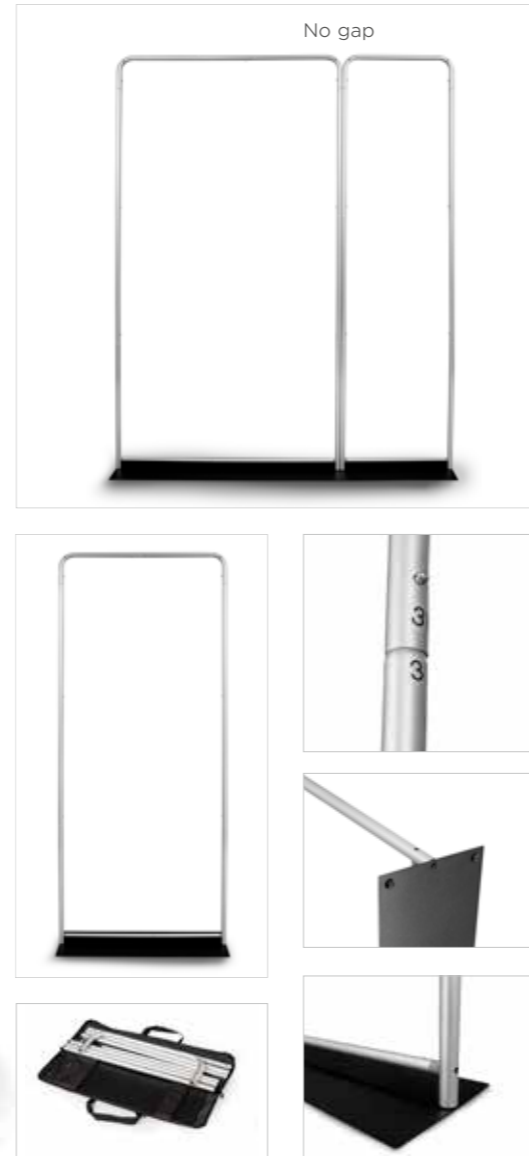

- base made of metal plate
- **very stable construction (profile - Ø 25 mm)**
- value for money
- simple handling
- double-sided system

This set includes: complete Expo system and a bag (the printout also can fit in).

- base de chapa metálica
- **perfil del sistema de aluminio (Ø 25 mm)**
- bajo coste del sistema
- gráficos a doble cara
- montaje sencillo y rápido

El kit incluye: sistema Atlantis Expo y bolsa de transporte.

- **profilé aluminium du système (Ø 25 mm)**
- les pieds ont été remplacés par une plaque métallique
- faible coût du système
- image recto-verso
- montage simple et rapide

Le kit comprend: un système Atlantis Expo, un sac de transport (l'impression peut également tenir dans).

60x230	5907451660409	4,30 kg
90x230	5907451660416	5,60 kg
120x230	5907451660423	8,00 kg
150x230	5907451660430	9,70 kg

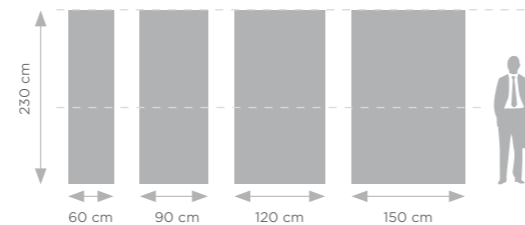

Recommended media and printing technology for this system:



Fabric
Sublimation printing



ADVERTISING WALLS

MEGA SEG™ SYSTEM

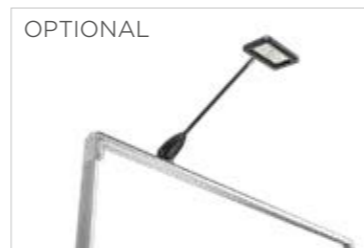
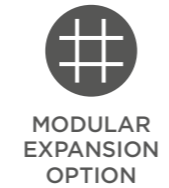

MEGA SEG SYSTEMS ARE DISTINGUISHED BY ITS PRE-ASSEMBLED DESIGN, WHICH SIMPLY NEEDS TO BE OPENED.

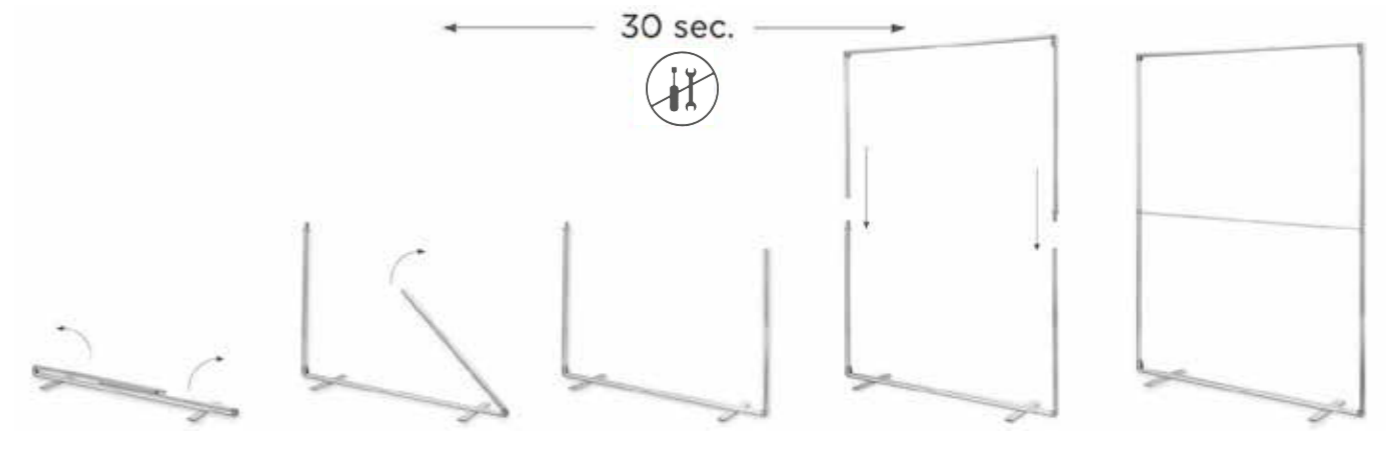

MEGA SEG SYSTEMS CAN BE CONNECTED TOGETHER USING SPECIAL CONNECTORS. THIS OFFERS ALMOST UNLIMITED POSSIBILITIES OF CREATING DIFFERENT SYSTEMS. CONNECTING THE PRODUCTS IN PARALLEL ALLOWS A SINGLE PRINT TO BE APPLIED, WITH NO VISIBLE GAPS BETWEEN THE SYSTEMS.



- ultralight, double-sided, modular system
- **flex system - faster and easier assembly thanks to its hinge-based construction**
- aluminium frame (4,2 cm)
- no tools assembly
- graphics mounted with silicone tape
- **several walls - one printout!**

The set includes: MEGA SEG system, a set of connectors (parallel - 4 pieces, top - 1 piece, bottom - 1 piece), transport bag.

- **flex sistema - montaje más rápido y sencillo gracias a su construcción con bisagras**

- marco de aluminio (4,2 cm)
- montaje sin herramientas
- impresión montada con cinta de silicona
- **¡varias soportes una impresión!**

El set incluye: sistema MEGA SEG™, juego de conectores (serie - 4 uds, superior - 1 ud, inferior - 1 ud), bolsa de transporte.

- **système flex - installation plus rapide et plus facile grâce à la conception basée sur les charnières**

- système modulaire ultraléger, double face
- montage sans outils
- cadre en aluminium (4,2 cm)
- l'image montée à l'aide d'une bande silicone
- **plusieurs panneaux - une seule impression!**

Le kit comprend: un système MEGA SEG™, un jeu de connecteurs (série - 4 pièces, supérieur - 1 pièce, inférieur - 1 pièce), un sac de transport.

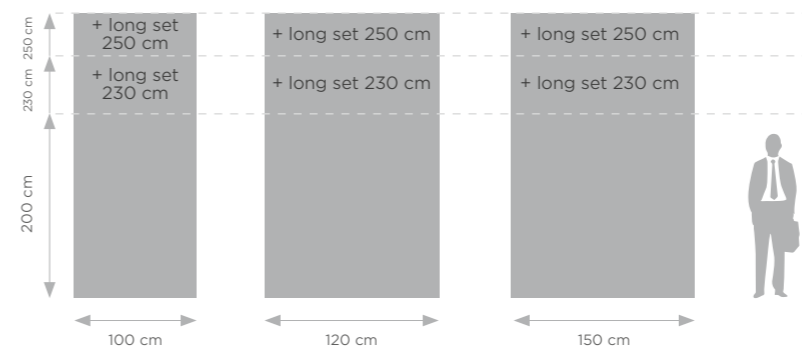

100x200	5907451668948	2,1 kg
120x200	5907451668931	2,6 kg
150x200	5907451668924	3,2 kg

Recommended media and printing technology for this system:

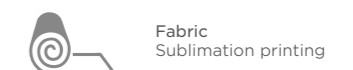

The Long Sets increase the height of the product up to 230 or 250 cm.

POP-UP STRAIGHT

BEST SELLER



- the best value for money
- "pop up" mechanism - express unfolding
- interchangeable briches

This set includes: Pop-up frame, set of construction bars, set of upper 3M magnetic bars, 3M magnetic tape, set of PVC boards.

- bajo precio/alta calidad
- sistema "pop up" - despliegue rápido del soporte
- las láminas intercambiables

El juego incluye: marco POP UP, juego de barras de construcción, juego de barras magnéticas superiores de 3M, cinta magnética de 3M, juego de tableros de PVC.

- prix bas/haute qualité
- système „pop up” - montage rapide
- panneaux interchangeables

Le kit comprend: un cadre Pop-Up, des barres de fixation pour les panneaux avec du ruban 3M, un jeu de barres de construction, une bande magnétique 3M et un jeu de panneaux avant et latéraux.

3x3 (in trolley case)	5907451660317	24 kg
3x3 (in counter case)	5907451666081	24 kg
3x4 (in trolley case)	5907451660324	28 kg
3x4 (in counter case)	5907451666098	28 kg

Case counter and trolley bag - page 86

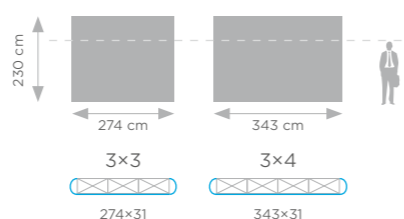

Recommended media and printing technology for this system:



POP-UP ARC

BEST SELLER



- the best value for money
- "pop up" mechanism - express unfolding
- interchangeable briches

This set includes: Pop-up frame, set of construction bars, set of upper 3M magnetic bars, 3M magnetic tape, set of PVC boards.

- bajo precio/alta calidad
- sistema "pop up" - despliegue rápido del soporte
- las láminas intercambiables

El juego incluye: marco POP UP, juego de barras de construcción, juego de barras magnéticas superiores de 3M, cinta magnética de 3M, juego de tableros de PVC.

- prix bas/haute qualité
- système „pop up” - montage rapide
- panneaux interchangeables

Le kit comprend: un cadre Pop-Up, des barres de fixation pour les panneaux avec du ruban 3M, un jeu de barres de construction, une bande magnétique 3M et un jeu de panneaux avant et latéraux.

3x3 (in trolley case)	5907451660331	24 kg
3x3 (in counter case)	5907451666104	24 kg
3x4 (in trolley case)	5907451660348	28 kg
3x4 (in counter case)	5907451666111	28 kg

Case counter and trolley bag - page 86

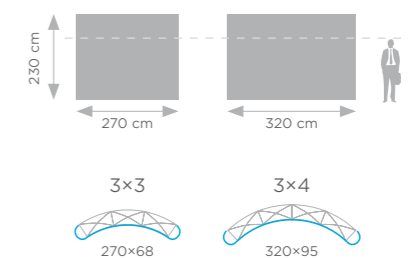

Recommended media and printing technology for this system:



STANDARD MAGNETIC POP-UP STRAIGHT



- special system of fast assembling element using built-in magnets
- "pop up" mechanism - express unfolding
- interchangeable bristles

This set includes: Standard Magnetic Pop-up frame, set of magnetic construction bars, set of upper 3M magnetic bars, 3M magnetic tape, set of PVC boards.

- sistema especial de montaje rápido con imanes integrados
- sistema „pop up” - despliegue rápido del soporte
- las láminas intercambiables

El juego incluye: marco Standard Magnetic Pop-up, juego de barras magnéticas de construcción, juego de barras magnéticas superiores de 3M, cinta magnética de 3M, juego de tableros de PVC.

- système „pop up” - montage rapide
- système spécial d'assemblage rapide d'un élément à l'aide d'aimants intégrés
- panneaux interchangeables

Le kit comprend: un cadre Standard Magnetic Pop-Up, des barres de fixation pour les panneaux avec du ruban 3M, un jeu de barres de construction, une bande magnétique 3M et un jeu de panneaux avant et latéraux.

3x3 (in trolley case)	5907451661024	22 kg
3x3 (in case counter)	5907451665985	22 kg
3x4 (in trolley case)	5907451661031	26 kg

Case counter and trolley bag - page 86

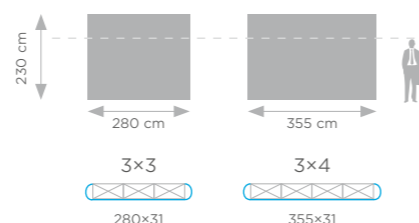

Recommended media and printing technology for this system:



STANDARD MAGNETIC POP-UP ARC



- special system of fast assembling element using built-in magnets
- "pop up" mechanism - express unfolding
- interchangeable bristles

This set includes: Standard Magnetic Pop-up frame, set of magnetic construction bars, set of upper 3M magnetic bars, 3M magnetic tape, set of PVC boards.

- sistema especial de montaje rapido con imanes integrados
- sistema „pop-up” - despliegue rapido del soporte
- las laminas intercambiables

El juego incluye: marco Standard Magnetic Pop-up, juego de barras magnéticas de construcción, juego de barras magnéticas superiores de 3M, cinta magnética de 3M, juego de tableros de PVC.

- système „pop up” - montage rapide
- système spécial d'assemblage rapide d'un élément à l'aide d'aimants intégrés
- panneaux interchangeables

Le kit comprend: un cadre Standard Magnetic Pop-Up, des barres de fixation pour les panneaux avec du ruban 3M, un jeu de barres de construction, une bande magnétique 3M et un jeu de panneaux avant et latéraux.

3x3 (in trolley case)	5907451660959	22 kg
3x3 (in case counter)	5907451665961	22 kg
3x4 (in trolley case)	5907451660966	26 kg
3x4 (in case counter)	5907451665978	26 kg

Case counter and trolley bag - page 86

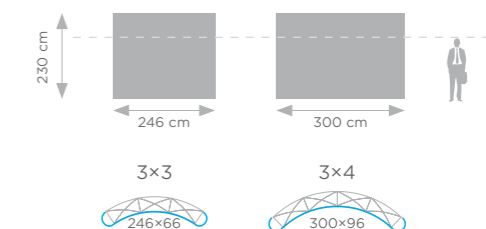

Recommended media and printing technology for this system:



PREMIUM MAGNETIC POP-UP STRAIGHT

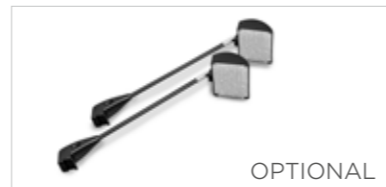
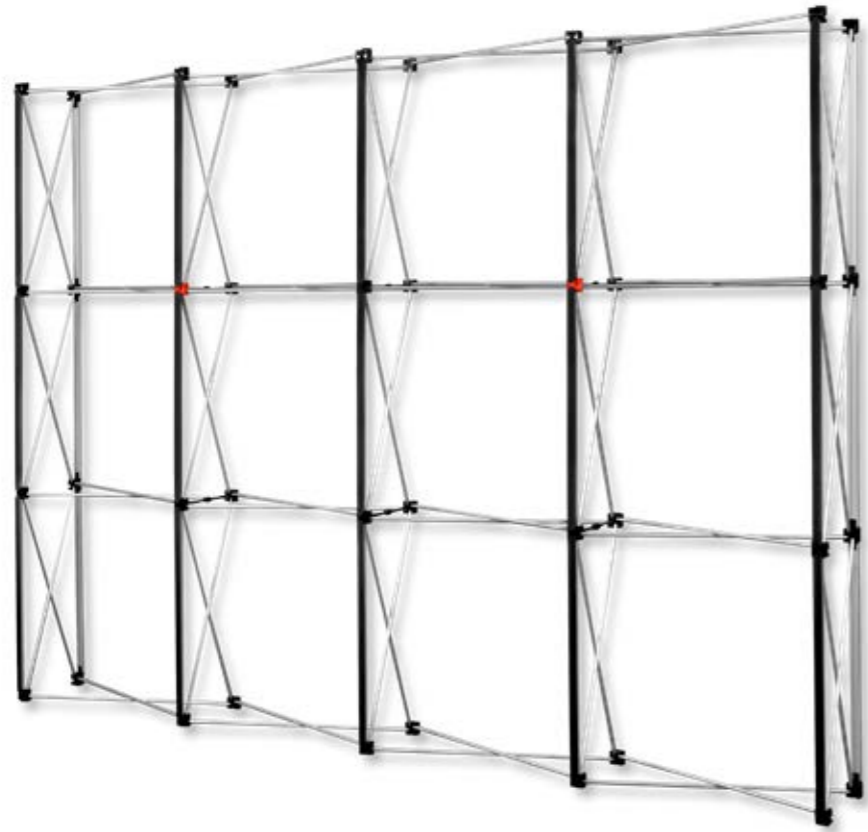

- high quality of construction
- "pop up" mechanism - express unfolding
- magnetic installation system
- interchangeable briches
- case counter

The set includes: Premium Magnetic Pop-up frame, top bars with adhesive tape for mounting PVC panels, a set of construction bars, a set of PVC panels, case counter.

- alta calidad de construcción
- sistema "pop up" - despliegue rápido del soporte
- montaje magnético de las lamas constructivas y los paneles
- las láminas intercambiables
- púlpito sobre ruedas

El juego incluye: marco Premium Magnetic Pop-Up, barras superiores con cinta adhesiva para el montaje de paneles de PVC, un juego de barras de construcción, un juego de paneles de PVC, púlpito sobre ruedas.

- très bonne qualité du produit
- système „pop up” - montage rapid
- assemblage magnétique des barres de construction et des panneaux
- panneaux interchangeables
- caisse comptoir à roulettes

Le kit comprend: un cadre Premium Magnetic Pop Up, des barres de fixation pour les panneaux, un jeu de barres de construction, un jeu de panneaux, une caisse comptoir à roulettes.

3x3	5907451666364	27 kg
3x4	5907451666371	31 kg

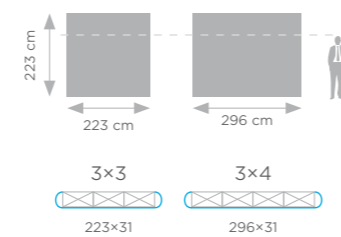

Recommended media and printing technology for this system:



PREMIUM MAGNETIC POP-UP ARC

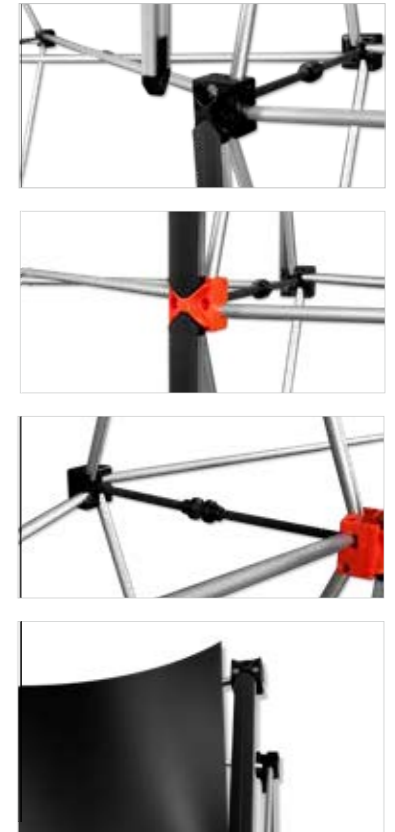
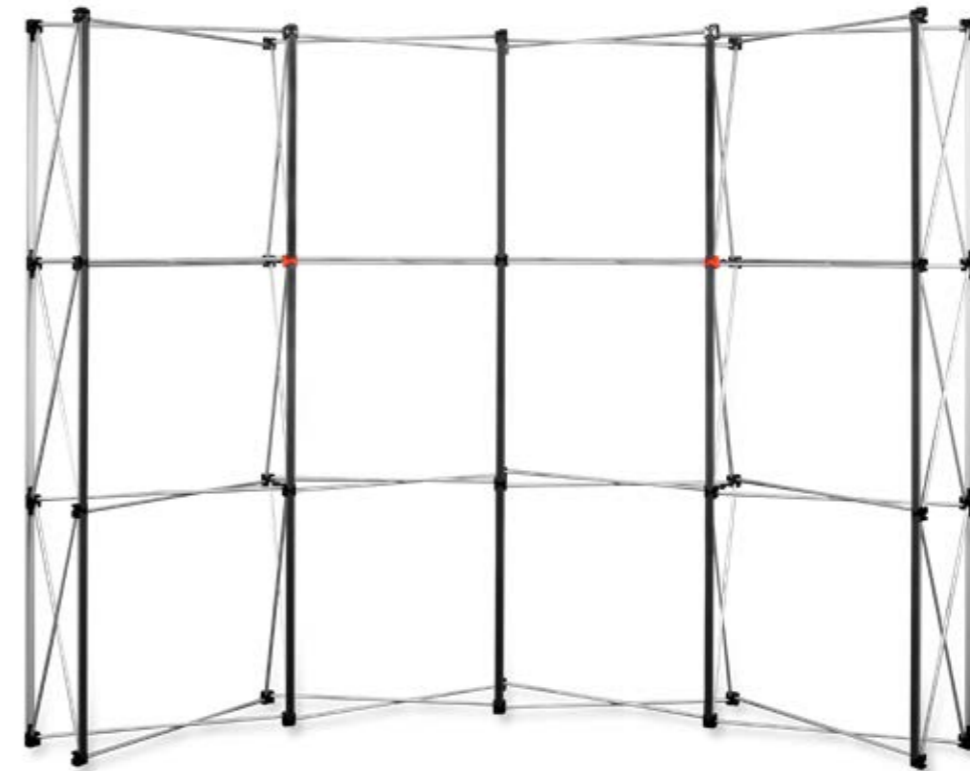

- high quality of construction
- "pop up" mechanism - express unfolding
- magnetic installation system
- interchangeable briches
- case counter

The set includes: Premium Magnetic Pop-up frame, top bars with adhesive tape for mounting PVC panels, a set of construction bars, a set of PVC panels, case counter.

- alta calidad de construcción
- sistema "pop up" - despliegue rápido del soporte
- montaje magnético de las lamas constructivas y los paneles
- las láminas intercambiables
- púlpito sobre ruedas

El juego incluye: marco Premium Magnetic Pop-Up, barras superiores con cinta adhesiva para el montaje de paneles de PVC, un juego de barras de construcción, un juego de paneles de PVC, púlpito sobre ruedas.

- très bonne qualité du produit
- système „pop up” - montage rapid
- assemblage magnétique des barres de construction et des panneaux
- panneaux interchangeables
- une caisse comptoir à roulettes

Le kit comprend: un cadre Premium Magnetic Pop Up, des barres de fixation pour les panneaux, un jeu de barres de construction, un jeu de panneaux, une caisse comptoir à roulettes.

3x3	5907451666388	27 kg
3x4	5907451666395	31 kg

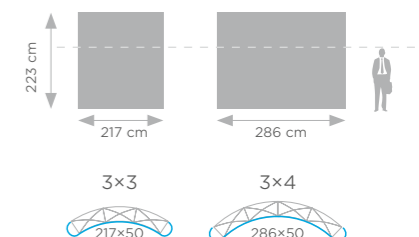

Recommended media and printing technology for this system:



BLACK PRO MAGNETIC POP-UP STRAIGHT

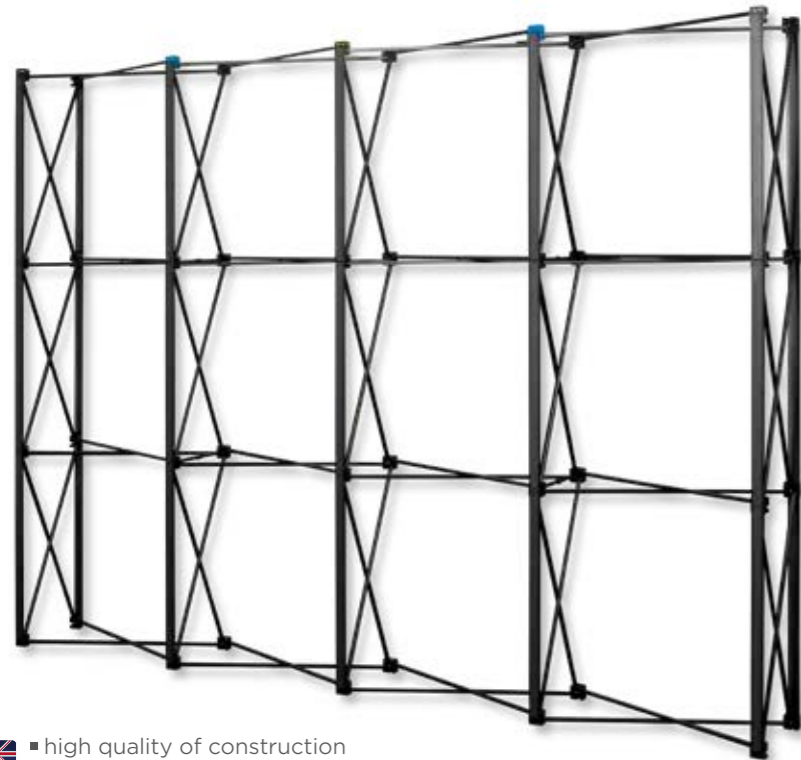

- high quality of construction
- "pop up" mechanism - express unfolding
- magnetic installation system
- interchangeable bristles
- case counter

The set includes: Black Pro Magnetic Pop-up frame, top bars with 3M adhesive tape for mounting PVC panels, a set of construction bars, a set of PVC panels, case counter.

- alta calidad de construcción
- sistema "pop up" - despliegue rápido del soporte
- montaje magnético de las lamas constructivas y los paneles
- las láminas intercambiables
- púlpito sobre ruedas

El juego incluye: marco Black Pro Magnetic Pop-Up, barras superiores con cinta adhesiva para el montaje de paneles de PVC, un juego de barras de construcción, un juego de paneles de PVC, púlpito sobre ruedas.

- la structure en aluminium épais garantit une très grande stabilité et la qualité supérieure du produit
- système „pop up” - montage rapid
- assemblage magnétique des barres de construction et des panneaux
- panneaux interchangeables
- une caisse comptoir à roulettes

Le kit comprend: un cadre Black Pro Magnetic Pop Up, des barres de fixation pour les panneaux, un jeu de barres de construction, un jeu de panneaux et une caisse comptoir à roulettes.

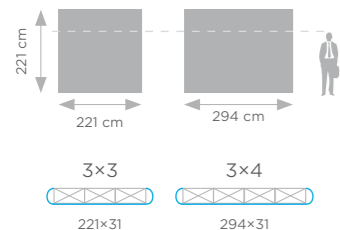

3x3	5907451666319	31 kg
3x4	5907451666326	34 kg

Recommended media and printing technology for this system:



Foil Solvent, UV, Latex

OPTIONAL

BLACK PRO MAGNETIC POP-UP ARC

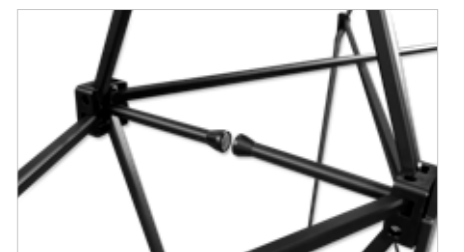
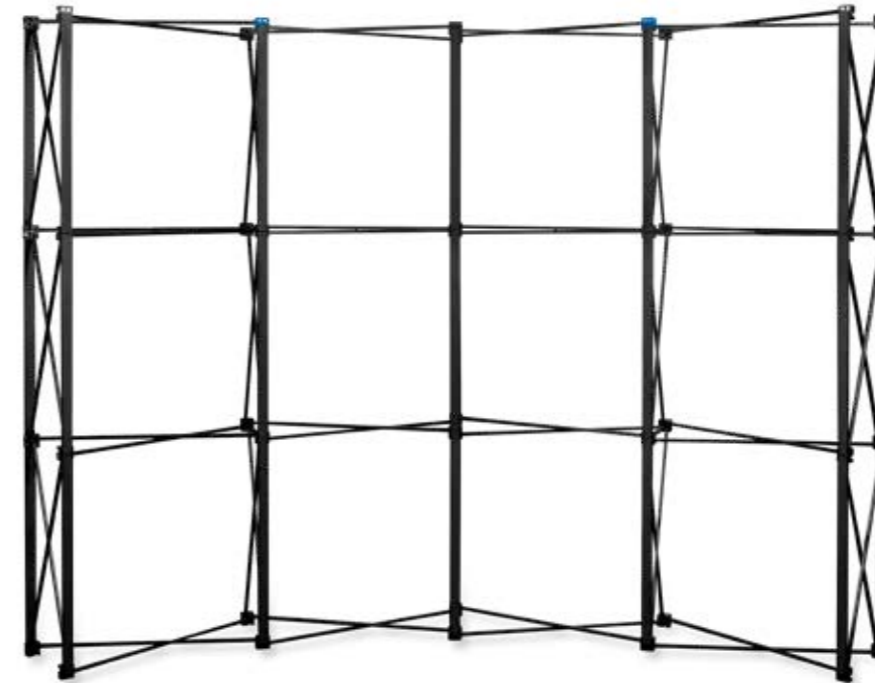

- high quality of construction
- "pop up" mechanism - express unfolding
- magnetic installation system
- interchangeable bristles
- case counter

The set includes: Black Pro Magnetic Pop-up frame, top bars with 3M adhesive tape for mounting PVC panels, a set of construction bars, a set of PVC panels, case counter.

- alta calidad de construcción
- sistema "pop up" - despliegue rápido del soporte
- montaje magnético de las lamas constructivas y los paneles
- las láminas intercambiables
- púlpito sobre ruedas

El juego incluye: marco Black Pro Magnetic Pop-Up, barras superiores con cinta adhesiva para el montaje de paneles de PVC, un juego de barras de construcción, un juego de paneles de PVC, púlpito sobre ruedas.

- la structure en aluminium épais garantit une très grande stabilité et la qualité supérieure du produit
- système „pop up” - montage rapid
- assemblage magnétique des barres de construction et des panneaux
- panneaux interchangeables
- une caisse comptoir à roulettes

Le kit comprend: un cadre Black Pro Magnetic Pop Up, des barres de fixation pour les panneaux, un jeu de barres de construction, un jeu de panneaux et une caisse comptoir à roulettes.

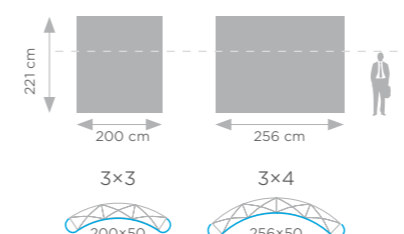

3x3	5907451666333	31 kg
3x4	5907451666340	34 kg

Recommended media and printing technology for this system:



Foil Solvent, UV, Latex

OPTIONAL

VELCRO POP-UP STRAIGHT

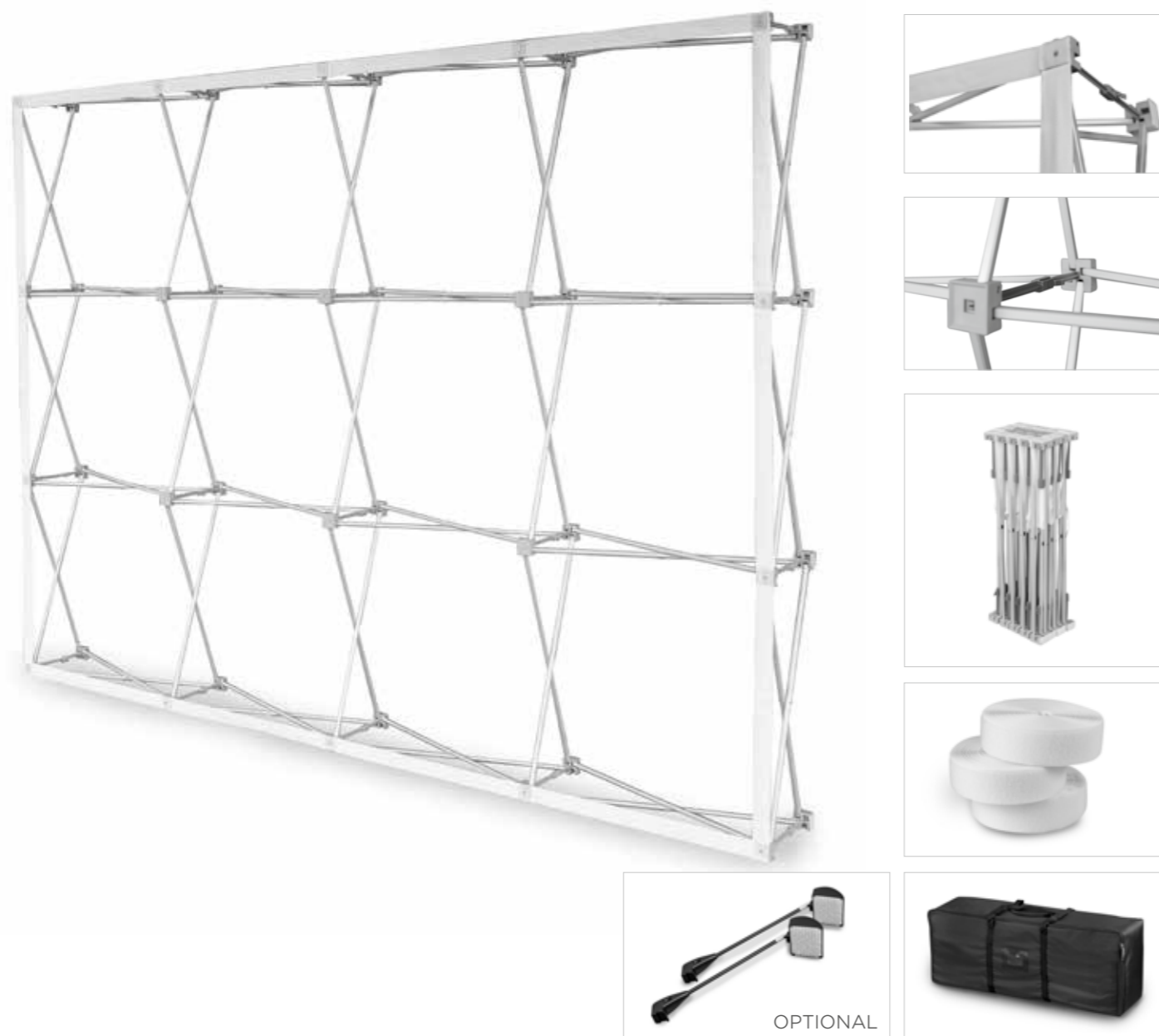

- wall designed for mounting textile graphics on it, using Velcro tape
- one piece graphics without PVC boards
- "pop up" mechanism - express unfolding

This set includes: Velcro Pop-up frame, Velcro tape, Canvas bag.

- pared diseñada para montar gráficos textiles en ella, utilizando cinta de velcro
- gráficos de una sola pieza sin tableros de PVC
- sistema "pop up" - despliegue rápido del soporte

El juego contiene: marco Velcro Pop-up, cinta de velcro para coser los gráficos, bolsa de transporte.

- système „pop up” - montage rapid
- impression fixée par velcro
- image = un élément de tissu

Le kit comprend: un cadre Velcro Pop-up, une bande Velcro à coudre dans l'image et un sac type Canvas.

3x3	5907451660973	8,5 kg
3x4	5907451660980	10 kg

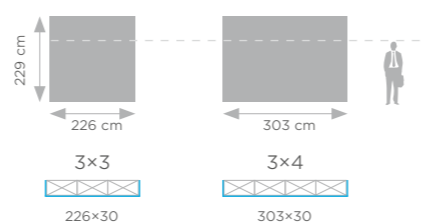

Recommended media and printing technology for this system:

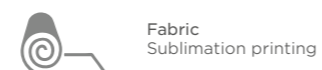

VELCRO POP-UP ARC



- wall designed for mounting textile graphics on it, using Velcro tape
- one piece graphics without PVC boards
- "pop up" mechanism - express unfolding

This set includes: Velcro Pop-up frame, Velcro tape, Canvas bag.

- pared diseñada para montar gráficos textiles en ella, utilizando cinta de velcro
- gráficos de una sola pieza sin tableros de PVC
- sistema "pop up" - despliegue rápido del soporte

El juego contiene: marco Velcro Pop-up, cinta de velcro para coser los gráficos, bolsa de transporte.

- système „pop up” - montage rapid
- impression fixée par velcro
- image = un élément de tissu

Le kit comprend: un cadre Velcro Pop-up, une bande Velcro à coudre dans l'image et un sac type Canvas.

3x3	5907451660997	8,5 kg
3x4	5907451661000	10 kg

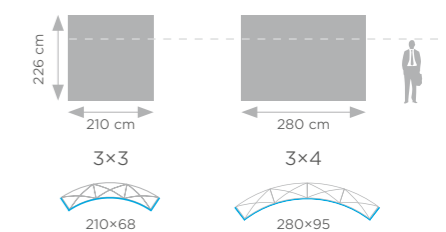

Recommended media and printing technology for this system:



ATLANTIS STRAIGHT

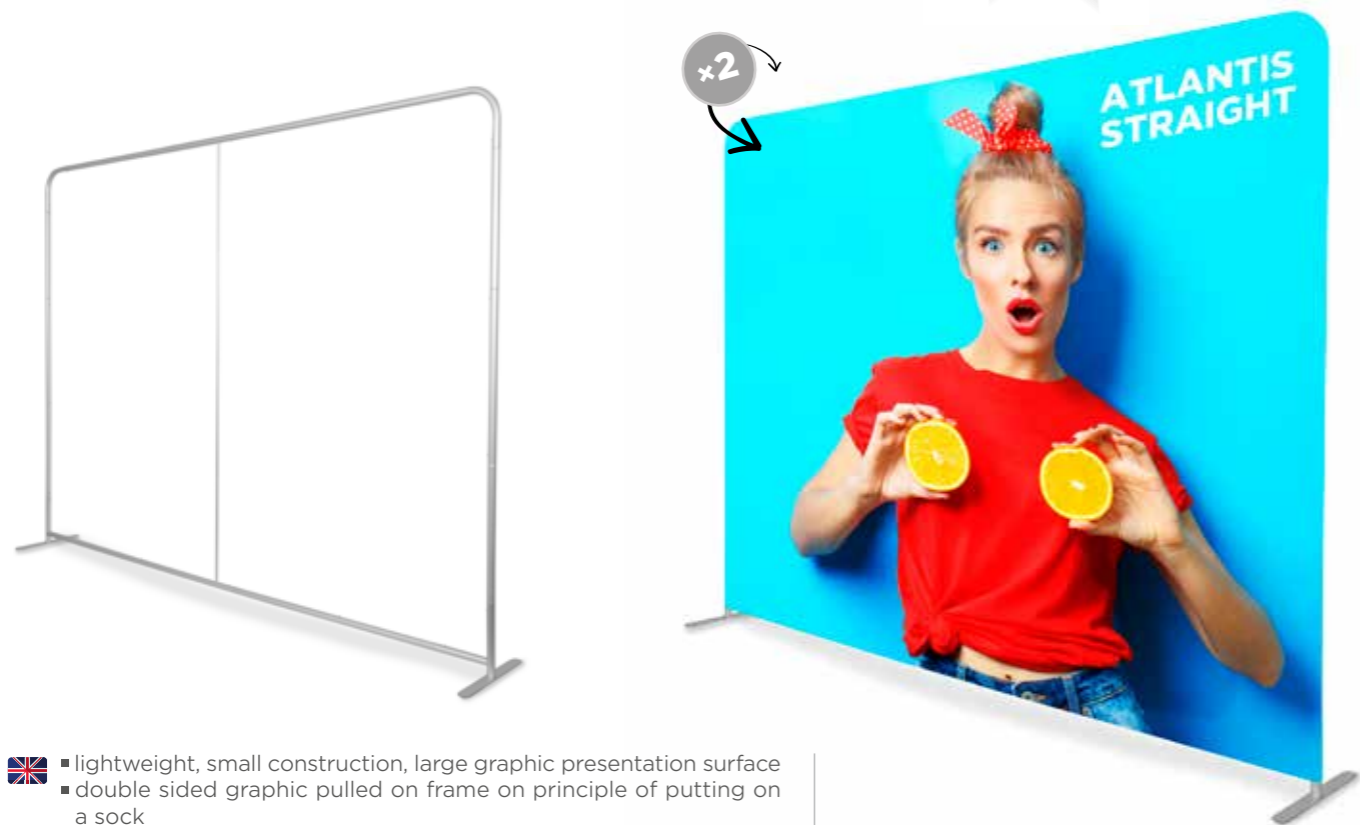

- lightweight, small construction, large graphic presentation surface
- double sided graphic pulled on frame on principle of putting on a sock
- quick assembly
- value for money

This set includes: Atlantis frame and a Canvas bag.

- ligero, construcción pequeña, gran superficie de presentación gráfica
- gráfico de doble cara colocado en el marco siguiendo el principio de poner un calcetín
- montaje rápido
- buena relación calidad-precio

El conjunto incluye: marco Atlantis, bolsa de transporte.

- l'image (imprimée sur tissu) est enfilée comme on enfle une chaussette
- construction ultralégère
- montage extrêmement facile
- prix attractif

Le kit comprend: un mur d'exposition Atlantis, un sac de transport type Canvas.

250x230	5907451661109	7 kg
300x230	5907451661116	8 kg
400x230	5907451661123	9 kg
590x230	5907451663769	15 kg

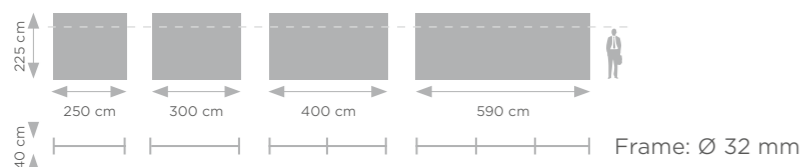

Recommended media and printing technology for this system:



OPTIONAL

ATLANTIS ARC



- thanks to the curved sides, part of the graphics is also visible from the side.
- lightweight, small construction, large graphic presentation surface
- double sided graphic pulled on frame on principle of putting on a sock
- quick assembly
- value for money

This set includes: Atlantis frame and a Canvas bag.

- gracias a los laterales curvos, parte de los gráficos también son visibles desde los lados
- ligero, construcción pequeña, gran superficie de presentación gráfica
- gráfico de doble cara colocado en el marco siguiendo el principio de poner un calcetín
- montaje rápido
- buena relación calidad-precio

El conjunto incluye: marco Atlantis, bolsa de transporte.

- l'image (imprimée sur tissu) est enfilée comme on enfle une chaussette
- construction ultralégère
- montage extrêmement facile
- prix attractif

Le kit comprend: un mur d'exposition Atlantis, un sac de transport type Canvas.

250x230	5907451661154	5 kg
300x230	5907451661161	6 kg
400x230	5907451661178	7 kg
530x230	5907451661185	10 kg

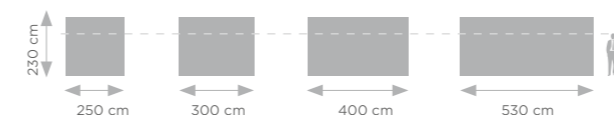

Recommended media and printing technology for this system:

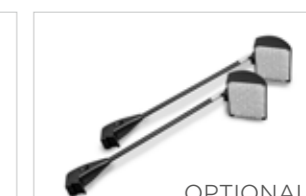
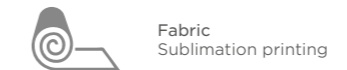

OPTIONAL

ATLANTIS S-SHAPE



- very impressive version of the Atlantis wall
- lightweight, small construction, large graphic presentation surface
- double sided graphic pulled on frame on principle of putting on a sock
- quick assembly
- value for money

This set includes: Atlantis frame, Canvas bag.

- una versión muy impresionante del Atlantis marco
- ligero, construcción pequeña, gran superficie de presentación gráfica
- gráfico de doble cara colocado en el marco siguiendo el principio de poner un calcetín
- montaje rápido
- buena relación calidad-precio

El conjunto incluye: marco Atlantis, bolsa de transporte.

- l'image (imprimée sur tissu) est enfilée comme on enfle une chaussette
- construction ultralégère
- montage extrêmement facile
- prix attractif

Le kit comprend: un mur d'exposition Atlantis, un sac de transport type Canvas.

250x230	5907451663097	5 kg
300x230	5907451661192	6 kg
400x230	5907451661208	7 kg
500x230	5907451661215	9 kg
650x230	5907451661222	11 kg

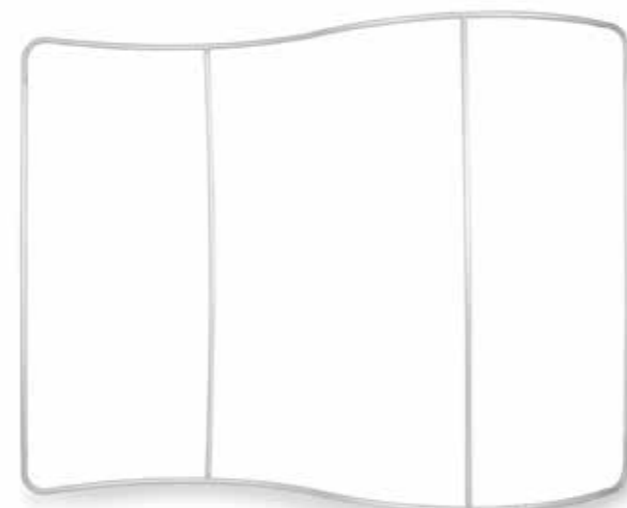
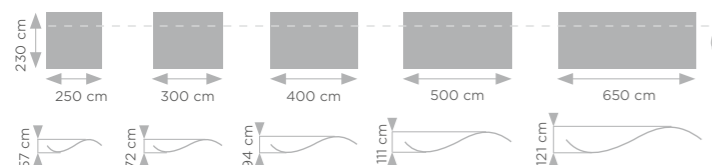

Frame: Ø 32 mm



OPTIONAL

Recommended media and printing technology for this system:



Fabric Sublimation printing

ATLANTIS U-SHAPE



- graphic pulled on frame on principle of putting on a sock
- extra legs make the system very stable

This set includes: Atlantis frame and a Canvas bag.

- gráfico colocado en el marco según el principio de ponerse un calcetín
- las patas adicionales hacen que el sistema sea muy estable

El conjunto incluye: marco Atlantis, bolsa de transporte.

- l'image (imprimée sur tissu) est enfilée comme on enfle une chaussette
- des jambes supplémentaires rend le système très stable

Le kit comprend: un mur d'exposition Atlantis, un sac de transport type Canvas.

250x230	5907451669884	5 kg
300x230	5907451661239	6 kg

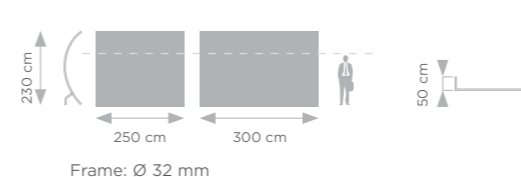

Frame: Ø 32 mm

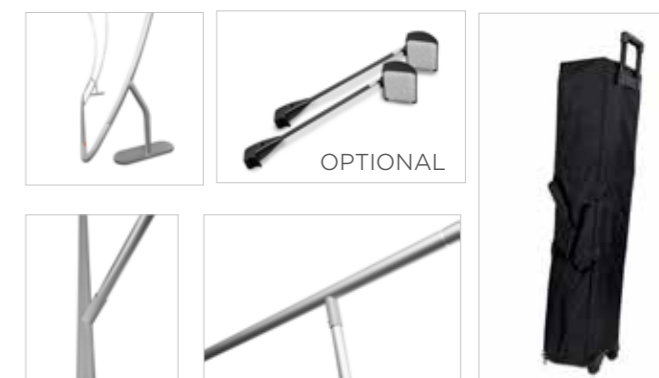

OPTIONAL

Recommended media and printing technology for this system:

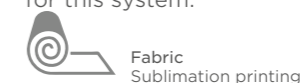

Fabric Sublimation printing

COMBI SYSTEMS

UK Shelving system for Atlantis (straight) walls. Thanks to this simple solution, each wall can become a complete, independent and very functional exhibition system. Perfect for promotional, educational and fair stands. The system has 3 horizontal black shelves made of thick plastic imitating wood, or 3 pockets for catalogs and leaflets, made of thick plexiglass. In the upper part of the system, there is a board on which a company logo or other graphics can be printed (foil).

ES Sistema de estanterías para marco Atlantis (rectas). Gracias a esta sencilla solución, cada pared puede convertirse en un sistema de exposición completo, independiente y muy funcional. Perfecto para stands promocionales, educativos y feriales. El sistema cuenta con 3 estantes horizontales negros fabricados en plástico grueso que imita la madera, o 3 bolsillos para catálogos y folletos, fabricados en plexiglas grueso. En la parte superior del sistema, hay un tablero en el que se puede imprimir el logotipo de la empresa u otros gráficos (lámina).

FR Système d'étagères conçu pour les murs mur d'image Atlantis (droits). Grâce à cette solution simple, chaque mur peut devenir un système d'exposition complet, indépendant et hautement fonctionnel. Il est idéal pour les stands promotionnels, éducatifs et de foire. Le système comprend horizontales noires en plastique épais qui ressemblent à du bois ou de 3 pochettes pour catalogues et brochures en acrylique épais. La partie supérieure du système est équipée d'un panneau sur lequel le logo de l'entreprise ou d'autres graphiques peuvent être imprimés (sur film).

COMBI 1



COMBI 2



The set contains the COMBI system only. The Atlantis wall must be purchased separately.

Combi 1	5907451665039	12 kg
Combi 2	5907451665022	8 kg

VERSUM

UK walls intended for big size frontlit banner graphics
 value for money
 adjustable frame, which can obtain various sizes
 stable construction

These sets include: Versum frame and a transport bag.

ES paredes diseñadas para grandes dimensiones gráficos frontales iluminados
 buena relación calidad-precio
 estructura ajustable, que puede adaptarse a varios tamaños
 construcción esta

El kit incluye: marco Versum plegable, bolsa de transporte.

FR destinés aux images de bannières de grande surface
 la structure fonctionne avec des tubes télescopiques
 grâce auxquels le cadre est réglable et peut avoir différentes dimensions
 bas prix du système

Le kit comprend: un cadre Versum, un sac de transport.

Recommended media and printing technology for this system:



VERSUM

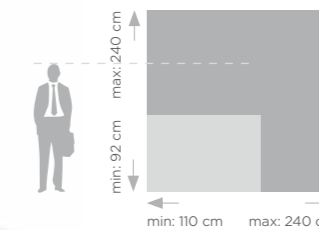
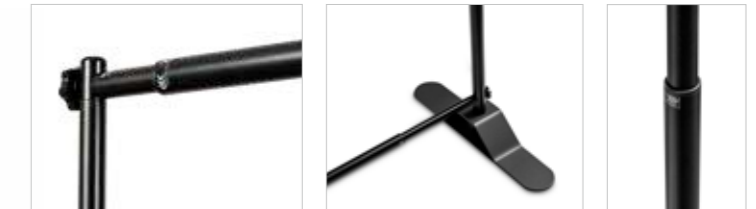

5907451661086	5,8 kg

Frame: Ø 22 mm

VERSUM XL

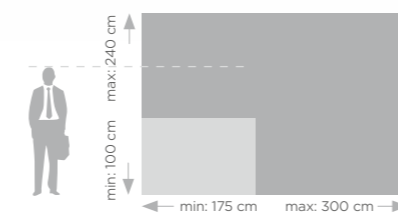
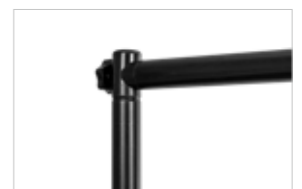

5907451661093	9,5 kg

Frame: Ø 32 mm



ADVERTISING WALL ACCESSORIES

BAGS AND CASES

I CASE COUNTER



- 2 in 1 – trolley case and a counter
 - excellent set together with the wall
 - varnished tabletop is an additional option
- This set includes: Counter, PVC Panel board and a tape for graphics assembly.

- 2 en 1: maleta con ruedas y mostrador
 - excelente conjunto junto con la pared
 - la mesa barnizada es una opción adicional.
- El conjunto incluye: pulpito sobre ruedas, panel de PVC y cinta para el montaje de gráficos.

- 2en1: sac à roulettes et comptoir
 - excellent ensemble avec le mur
 - le plateau de table verni est une option supplémentaire
- Le kit comprend: une caisse comptoir à roulettes, une bande magnétique 3M et un panneau pour coller l'image imprimée.

I CANVAS BAG



Recommended for walls with graphic not presented on PVC boards.

Recomendado para paredes sin gráficos impresos en tableros de PVC.

Recommandé pour les murs dont le graphisme n'est pas présenté sur PVC.

Canvas Bag	5907451662946	1 kg
Trolley case	5907451660867	5 kg
Counter	5907451660874	12 kg
Counter top	5907451663073	6 kg

I TROLLEY CASE



- additional padding makes this case very stable
- easy to carry thanks to wheels

- el acolchado adicional hace que esta maleta sea muy estable
- fácil de transportar gracias a sus ruedas

- un rembourrage supplémentaire rend cette valise très stable
- facile à transporter grâce à ses roulettes

LIGHTING

I HALOGEN



5907451660911

I LED



LED for Mega Seg system	5907451668887
LED for Pop-up & Atlantis walls	5907451660928
LED for Premium Pop-up walls	5907451666418

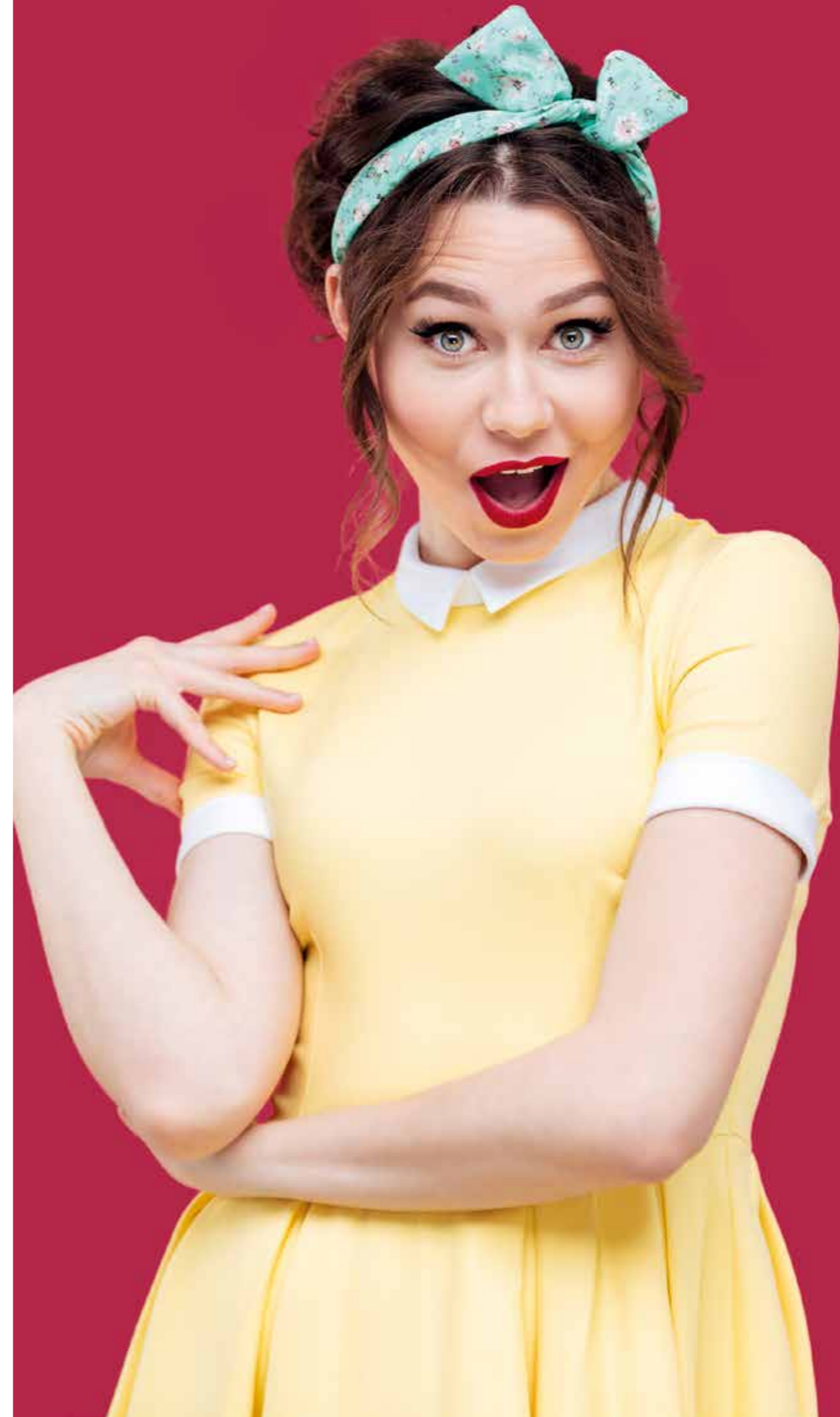

COUNTERS & BROCHURE HOLDERS

PROMO COUNTERS

- thanks to the simplicity of assembly, they have gained great popularity in many markets
- the walls of this system are made of cellular PVC, mounted to the wooden tabletop and wooden base with velcro straps
- ultralight counter

These sets include: counter top and base packed in transport bag, PVC panel packed in separate transport tube.

- gracias a la simplicidad de su montaje, han ganado gran popularidad en muchos mercados
- las paredes de este sistema están fabricadas en PVC celular, montadas sobre el tablero de madera y la base de madera con tiras de velcro
- mostrador ultraligero

El juego contiene: tablero de madera y base de madera embaladas en una bolsa de transporte, topper de PVC embalado en un tubo de transporte separado.

- apprécié avant tout pour la simplicité de montage
- plateau en bois solide
- les parois en PVC cellulaire sont assemblées au plateau et au socle à l'aide de fermetures velcro

Le kit comprend: un plateau en bois et un socle en bois emballés dans un sac de transport, un panneau PVC emballé dans un tube de transport séparé.

Recommended media and printing technology for this system:



PROMO 0

NEW STRONG TOP

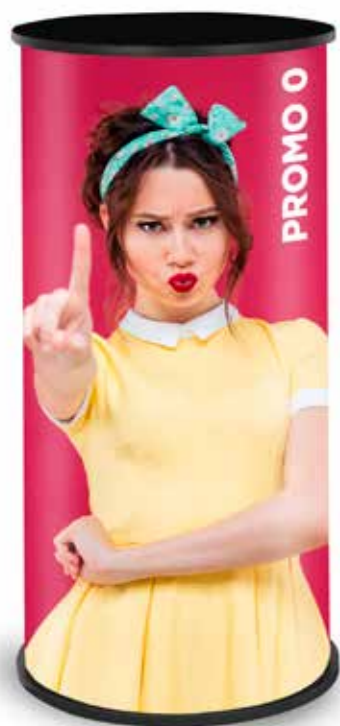

5907451661437



5 kg

Counter

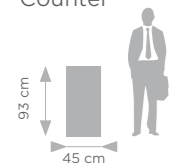

Table top



PROMO 1

NEW STRONG TOP



Product also available with shelf.



5907451661444



10 kg

Counter

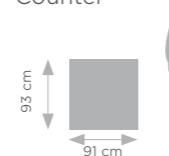
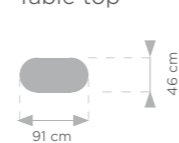

Table top



PROMO 2

BEST SELLER

NEW STRONG TOP

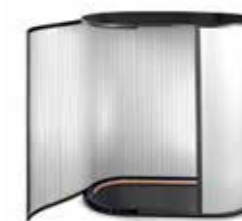

Product also available with shelf.



Counter

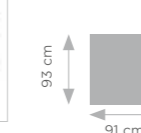
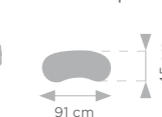

Table top



5907451661451



10 kg

PROMO 3

NEW STRONG TOP



Counter

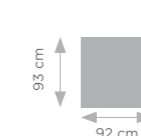
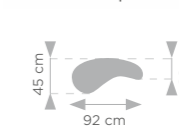

Table top



5907451663714



8 kg

PROMO 4

NEW STRONG TOP



Product also available with shelf.



Counter

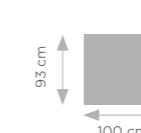
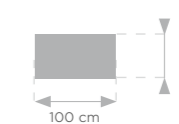

Table top



5907451669112



10 kg

PROMO 2 PLUS COUNTER

- the walls of this system are made of cellular PVC, mounted to the wooden tabletop and wooden base with velcro straps
- practical topper

This set includes: counter top, base and topper packed in transport bag, PVC panel packed in separate transport tube.

- las paredes de este sistema están fabricadas en PVC celular, montadas sobre el tablero de madera y la base de madera con tiras de velcro
- práctico topper

El juego incluye: tablero madera, base de madera y topper embalados en una bolsa de transporte, brida de PVC embalado en un tubo de transporte separado.

- plateau en bois solide
- assemblage à l'aide de fermetures velcro, sans outils
- topper pratique

Le kit comprend: dans le sac de transport - un plateau en bois, un socle en bois, un topper; dans le tube de transport - un panneau PVC.

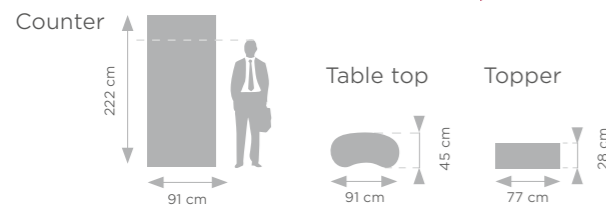

Recommended media and printing technology for this system:



Product also available with shelf.

POP-UP VELCRO COUNTER



- "pop up" mechanism - express unfolding
- graphics mounted with Velcro tape
- ultralight, useful, practical shelf in set

The set includes: counter Velcro, wooden top, velcro tape, wooden shelf, transport bag.

- mecanismo "pop up" - despliegue instantáneo del soporte
- fijación rápida de la impresión con velcro
- construcción ligera y estable
- estante práctico en el conjunto

El juego incluye: mostrador Velcro, tablero madera, velcro para coser los gráficos, estante de madera, bolsa de transporte.

- mécanisme „pop up” - dépliage rapide du cadre
- installation rapide de l'impression à l'aide de fermetures velcro
- construction légère et stable
- étagère pratique

Le kit comprend: un comptoir Velcro Pop-up, un plateau en bois, du Velcro pour coudre l'image, une étagère en bois, un sac de transport.



Recommended media and printing technology for this system:



TOPPER COUNTER

- counter made entirely of PVC board
 - ultralight and stable construction
 - perfect as a tool during supermarket promotions
- This set includes: Topper counter and a carrying bag.

- mostrador fabricado íntegramente con tablero de PVC
- estructura ultraligera y estable
- perfecto como herramienta durante las promociones en supermercados

Este conjunto incluye: mostrador Topper, bolsa de transporte.

- un comptoir léger et stable, entièrement réalisé en panneau PVC
- structure légère et stable
- topper pratique

Le kit comprend: un cadre du comptoir Topper, un sac de transport.

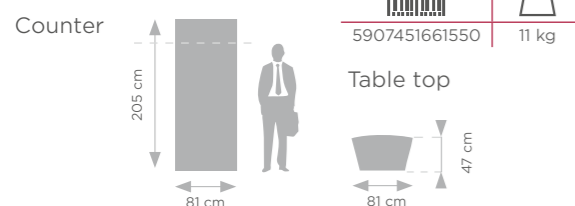

Recommended media and printing technology for this system:



PRESTON COUNTERS

- heavy, very solid and stable construction
- high quality and very impressive graphics mount using a silicone band
- thanks to the use of fabric as a graphic carrier, this counter can be illuminated from inside

These sets include: Preston counter and a transport bag.

- construcción pesada, muy sólida y estable
- gráficos de alta calidad y muy impresionantes montaje mediante una banda de silicona
- gracias al uso de tela como soporte gráfico, este mostrador puede iluminarse desde el interior

El juego incluye: mostrador Preston, bolsa de transporte.

- un comptoir très solide et résistant qui peut être rétroéclairé de l'intérieur
- l'installation de l'image à l'aide de bande silicone ne prend que quelques secondes
- le plateau en bois et le socle, „pieds” en métal

Le kit comprend: un comptoir Preston, un sac de transport.

Recommended media and printing technology for this system:



PRESTON OVAL

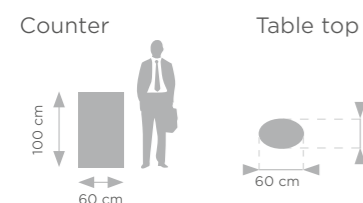

PRESTON TRIANGLE

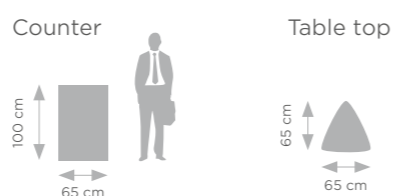

PRESTON WAIST



Counter



Table top

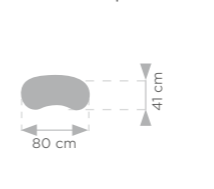

PRESTON RECTANGLE



Counter



Table top

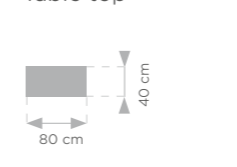

PRESTON XXL



Counter

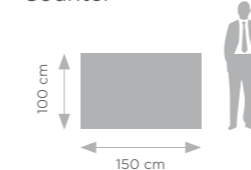

Table top



PRESTON AUTOMATIC COUNTERS

- automatic and very quick assembly
- stable base and sizable top
- perfect choice for fair and promoting purposes

These sets include: Preston counter and a transport bag.

- montaje automático y muy rápido
- base estable y superficie amplia
- la elección perfecta para ferias y promociones

El juego incluye: mostrador Preston, bolsa de transporte.

- dépliage automatique du comptoir
- construction solide
- un choix idéal pour les foires et les promotions

Le kit comprend: un comptoir Preston, un sac de transport.

Recommended media and printing technology for this system:  Fabric Sublimation printing

PRESTON AUTOMATIC OVAL



Counter Table top

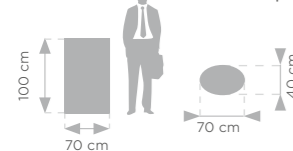

PRESTON AUTOMATIC RECTANGLE



Counter Table top

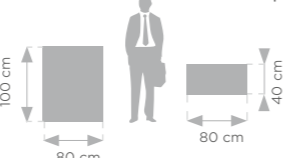

PRESTON AUTOMATIC OVAL LED



Counter Table top

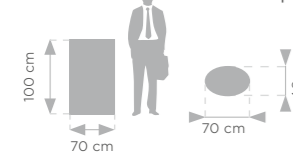

PRESTON AUTOMATIC RECTANGLE LED



Counter Table top

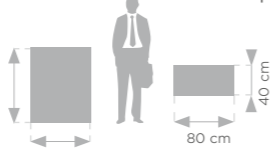

POP-UP COUNTERS

- POP-UP construction
- graphics mounted on PVC boards
- attractive appearance

The set includes: Pop Up counter, PVC panel, 3M magnetic tape, transport bag.

- mecanismo "pop-up" - despliegue instantáneo del soporte
- gráficos montados sobre paneles de PVC
- práctico estante y parte superior barnizada

El juego incluye: mostrador Pop-up, tablero de PVC, banda magnética, bolsa de transporte.

- mécanisme „pop-up” - dépliage rapide du cadre
- installation du panneau à l'aide d'aimants
- étagère pratique et plateau laqué

Le kit comprend: un comptoir Pop-Up, un panneau PVC, une bande magnétique, un sac de transport.

POP-UP 2x1



Counter Table top

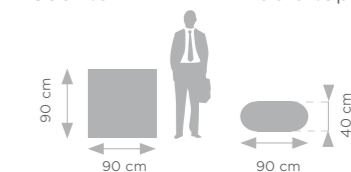

Recommended media and printing technology for this systems:



POP UP 2x2



Counter Table top



Recommended media and printing technology for this systems:



LUNIX™ COUNTER



- double-sided system
 - **wide aluminium profile (12 cm)**
 - integrated LED lighting
 - no tools assembly
 - silicon tape mounted printout
 - wheeled transport bag
- The set includes: LUNIX™ counter, power adapter, transport bag.

- sistema doble cara
 - **perfil ancho de aluminio (12 cm)**
 - iluminación LED integrada
 - montaje sin herramientas
 - impresión montada con cinta de silicona
 - bolsa de transporte con ruedas
- El conjunto incluye: mostrador LUNIX™, adaptador de corriente, bolsa de transporte.

- système double face
 - **large profilé en aluminium (12 cm)**
 - éclairage LED intégré
 - assemblage sans outils
 - impression sur ruban adhésif siliconé
 - sac de transport à roulettes
- Le kit comprend: un comptoir LUNIX™, une alimentation, un sac de transport.

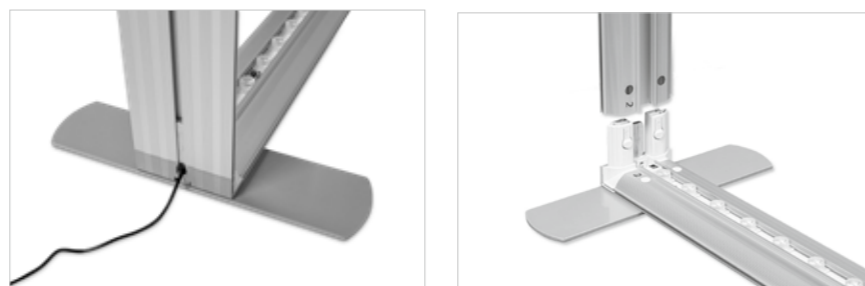

Recommended media and printing technology for this system:



LED BOX™ COUNTER



- double-sided LED system
 - durable aluminium frame (8 cm)
 - no tools assembly
 - silicon tape mounted printout
- The set includes: LED BOX counter, power adapter, transport bag.

- iluminación LED integrada
 - marco de aluminio resistente (8 cm)
 - montaje sin herramientas
 - impresión montada con cinta de silicona
- El conjunto incluye: mostrador LED BOX, adaptador de corriente, bolsa de transporte.

- rétroéclairé, double face et facile à utiliser
 - aluminium anodisé solide (8 cm)
 - montage sans outils
 - l'image montée à l'aide d'une bande silicone
- Le kit comprend: un comptoir LED BOX, une alimentation, un sac de transport.

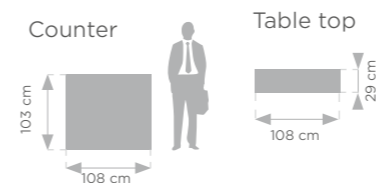
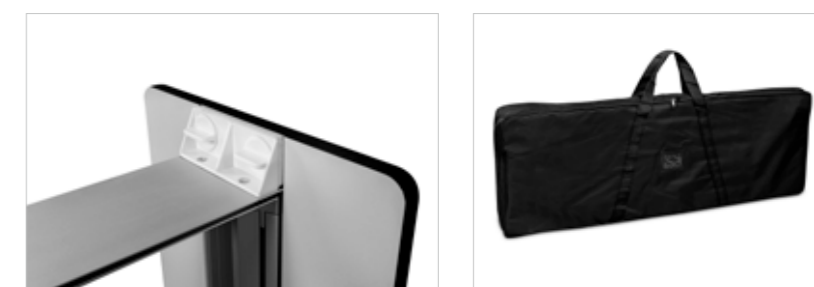
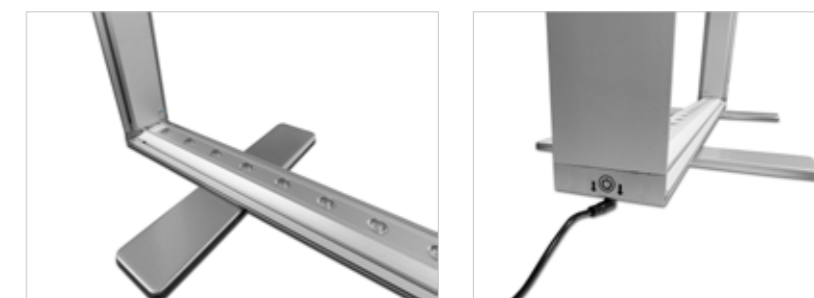

Recommended media and printing technology for this system:



LED BOX™ COUNTER WITH SHELF

NEW!

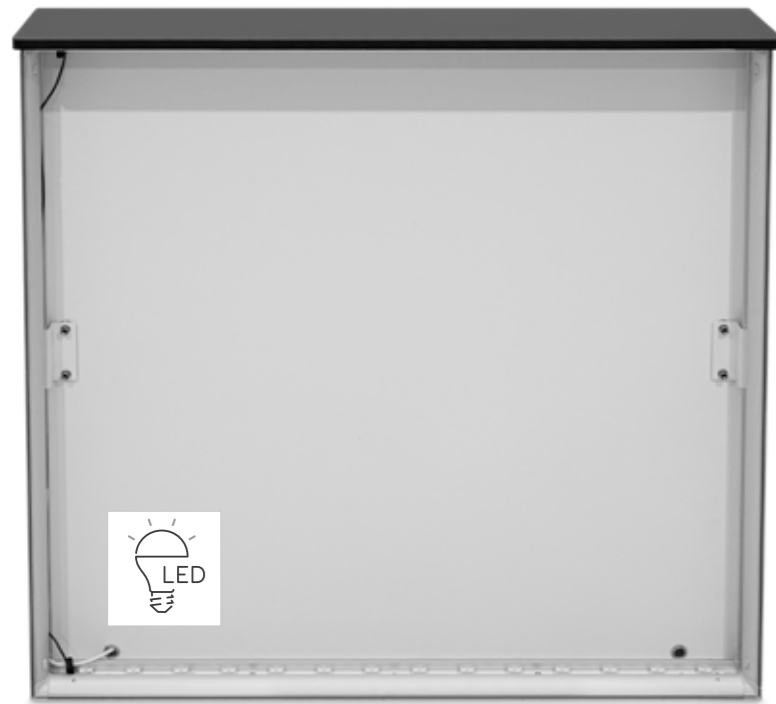

- LED
- NO TOOLS
- 6,5 cm
- ALUMINIUM PROFILE
- SILICONE TAPE MOUNTED PRINTOUT



- LED counter with practical shelf
- aluminium frame (6,5 cm)
- no tools assembly
- silicon tape mounted printout

The set includes: LED BOX with shelf counter, blackback material, power adapter, transport bag.

- mostrador LED con práctico estante
- perfil de aluminio (6,5 cm)
- montaje sin herramientas
- impresión montada con cinta de silicona

El conjunto incluye: LED BOX mostrador con estante, blackback material, adaptador de corriente, bolsa de transporte.

- comptoir LED avec étagère pratique
- profilé en aluminium (6,5 cm)
- montage sans outils
- impression montée sur ruban silicone

Le kit comprend : un comptoir LED BOX avec étagère, un blackback matériau, une alimentation, un sac de transport.

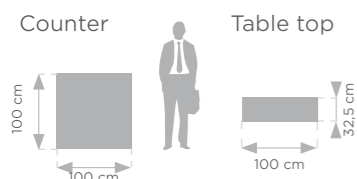

5907451666142 | 15 kg
Recommended media and printing technology for this system:



BACKLIGHT COUNTER

NEW!



- LED
- 70 LED BULBS
- SILICONE TAPE MOUNTED PRINTOUT
- NO TOOLS

- LED curtain enables the entire printout to be evenly illuminated

- the back of the curtain is opaque, which allows for even better highlighting of the graphics
- aluminium light strips
- aluminium profile (6.5 cm)

The set includes: BACKLIGHT counter, LED curtain, power adapter, transport bag.

- la cortina LED permite iluminar uniformemente toda la impresión

- la parte posterior de la cortina es opaca, lo que permite resaltar aún mejor los gráficos
- tiras de luz de aluminio
- perfil de aluminio (6,5 cm)

El conjunto incluye: mostrador BACKLIGHT, cortina LED, fuente de alimentación, bolsa de transporte.

- le rideau LED permet d'éclairer uniformément l'ensemble de l'impression

- l'arrière du rideau ne laisse pas passer la lumière, ce qui permet de mettre encore plus en valeur les graphismes
- bandes lumineuses en aluminium
- profilé en aluminium (6,5 cm)

Le kit comprend: un comptoir BACKLIGHT, rideau LED, une alimentation, un sac de transport.

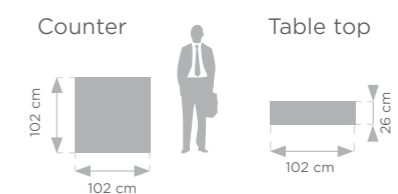

5907451662595 | 9,7 kg

Recommended media and printing technology for this system:





BROCHURE HOLDERS

MONTANA SILVER



- 
 - two-sided access to presented materials
 - designed for brochures in A4 and A3 format
 - small dimension after folding
 - made of aluminium and metal

- 
 - acceso por ambos lados a los materiales presentados
 - diseñado para folletos en formato A4 y A3
 - peso reducido, tamaño compacto cuando está plegado
 - fabricado en aluminio y metal

- 
 - accès aux documents présentés des deux côtés
 - conçu pour les brochures au format A4 et A3
 - faible poids, petites dimensions après le démontage
 - construction solide en aluminium





Product packed in transport bag or aluminium case.

		
A4	5907451660553	5,2 kg
A3	5907451669365	7,5 kg

MONTANA BLACK



- 
 - two-sided access to presented materials
 - designed for brochures in A4 and A3 format
 - small dimension after folding
 - made of aluminium and metal

- 
 - acceso por ambos lados a los materiales presentados
 - diseñado para folletos en formato A4 y A3
 - peso reducido, tamaño compacto cuando está plegado
 - fabricado en aluminio y metal

- 
 - accès aux documents présentés des deux côtés
 - conçu pour les brochures au format A4 et A3
 - faible poids, petites dimensions après le démontage
 - construction solide en aluminium

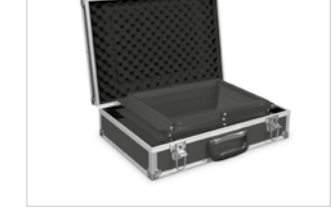

		
A4	5907451668962	5,2 kg
A3	5907451668955	7,5 kg

BOSTON



- bestseller
 - made entirely of metal, powder coated black
 - small dimension, lightweight frame
- superventas
 - fabricado íntegramente en metal, con recubrimiento en polvo negro
 - dimensiones reducidas, estructura ligera
- construction métallique légère
 - prix avantageux
 - les petites dimensions

A4 5907451660546 4,3 kg

ATLANTA



- solid metal construction
 - two-sided access to presented materials
 - small size after folding
- construcción metálica sólida
 - acceso por ambos lados a los materiales presentados
 - tamaño reducido tras plegarlo
- construction solide en métal
 - accès des deux côtés aux documents présentés
 - petites dimensions après le démontage

A4 5907451669051 6,6 kg

COLUMBIA



- pockets made of thick transparent plexiglass board
 - chromed base
 - a grip making it easy to handle
 - handy backpack included
- bolsillos fabricados en plexiglás transparente grueso
 - base cromada
 - asa que facilita su manejo
 - práctica mochila incluida
- porte-brochures d'une élégance exceptionnelle dont les poches ont été réalisées en plexiglas épais et transparent
 - le socle chromé
 - poignée facilitant le transport
 - sac à dos pratique pour le transport

A4 5907451660560 5 kg

LINCOLN



- extremely durable and strong stand
 - made of metal, powder coated gray and black
 - designed for catalogs and brochures in A4 format
 - bag included
- soporte extremadamente duradero y resistente
 - fabricado en metal, con recubrimiento en polvo gris y negro
 - diseñado para catálogos y folletos en formato A4
 - bolsa incluida
- construction exceptionnellement durable et solide
 - réalisé entièrement en métal, thermolaqué en gris et noir
 - conçu pour présenter les dépliants/catalogues au format A4
 - comprend un sac de transport

A4 5907451662489 6,5 kg

COUNTER DALLAS



- 🇬🇧 2in1 - counter and brochure holder
 - catalogs in A4 and A3 format will fit here
 - stable construction
- 🇪🇸 2 en 1 - mostrador + portafolletos
 - tamaño compacto cuando está plegado
 - construcción estable
- 🇫🇷 2en1 - comptoir et présentoir pour dépliants
 - petites dimensions après le démontage
 - Il sert à présenter les catalogues au format A4 et A3



5907451663592 10 kg

COUNTER CONCORD



- 🇬🇧 2in1 - counter and brochure holder
 - catalogs in A4 format will fit here
 - elegant table top made of light wood
 - counter folds into small dimensions and fits in a durable, elegant aluminum case
- 🇪🇸 2 en 1 - mostador + portafolletos
 - los catálogos en formato A4 caben aquí
 - tablero de madera
 - tamaño compacto una vez plegado
 - maletín de aluminio
- 🇫🇷 2en1 - comptoir + présentoir pour dépliants
 - le présentoir est conçu pour les dépliants/catalogues A4
 - plateau élégant en bois
 - petites dimensions après le démontage
 - valise en aluminium



A4 5907451660577 8 kg

VIRGINIA

- 🇬🇧 2in1 - info stand and brochure holder in one
 - A4 or universal pocket
 - snap frame for customized poster
 - very stable and strong system
- 🇪🇸 2 en 1: expositor informativo + portafolletos
 - placa informativa integrada
 - bolsillo para folletos de material acrílico grueso (A4 o universal)
- 🇫🇷 2en1 - stand d'information et porte-brochures
 - construction très solide en métal massif, thermolaqué en noir mat
 - plaque d'information intégrée
 - la poche pour dépliants est réalisée en acrylique très épais et conçue pour les formats maximum A4

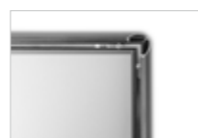

5907451664889 9 kg



POSTER FRAMES AND RAILS

POSTER RAILS

LISTONES PARA PÓSTERS
PROFILÉS PORTE-AFFICHES



- wide choice of sizes - custom sizes available on request
- possibility of mounting to a wall or ceiling
- "Express Clip" system - quick and simple assembly and graphics exchange
- thick profile made of anodized aluminum

This set includes: top rail with hooks and bottom rail.

- amplia variedad de tamaños - tamaños personalizados disponibles bajo pedido
- posibilidad de montaje en pared o techo
- sistema „Express Clip“ - montaje rápido y sencillo e intercambio de gráficos
- perfil grueso de aluminio anodizado

El juego incluye: riel superior con ganchos y riel inferior.

- grand choix de largeurs - les moulures peuvent être fabriquées sur mesure pour le client
- possibilité de fixation au mur ou au plafond
- système „Express Clip“ pour un montage et un remplacement
- rapides et faciles des graphiques
- aspect élégant
- profilé épais en aluminium anodisé

Le kit comprend: un profil supérieur avec crochets et un profil inférieur.

Recommended media and printing technology for this system:



STANDARD

40 cm (silver)	5907451662038	0,20 kg
60 cm (silver)	5907451661635	0,30 kg
85 cm (silver)	5907451660249	0,40 kg
100 cm (silver)	5907451660256	0,45 kg
120 cm (silver)	5907451660263	0,55 kg
150 cm (silver)	5907451660270	0,70 kg
200 cm (silver)	5907451660287	0,90 kg
60 cm (black)	5907451668344	0,30 kg
85 cm (black)	5907451668351	0,40 kg
100 cm (black)	5907451668368	0,45 kg
120 cm (black)	5907451668375	0,55 kg
150 cm (black)	5907451668382	0,70 kg
200 cm (black)	5907451668399	0,90 kg

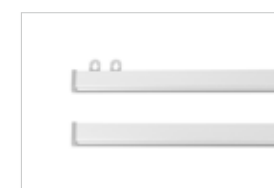

Available colours:



SLIM

40 cm	5907451662045	0,20 kg
60 cm	5907451662052	0,30 kg
85 cm	5907451662069	0,40 kg
100 cm	5907451662076	0,45 kg
120 cm	5907451662083	0,55 kg
150 cm	5907451662090	0,70 kg
200 cm	5907451663707	0,90 kg

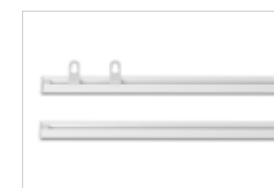

CLIP

40 cm	5907451662526	0,20 kg
60 cm	5907451662533	0,30 kg
85 cm	5907451662540	0,40 kg
100 cm	5907451662496	0,45 kg
120 cm	5907451662502	0,55 kg
150 cm	5907451662519	0,70 kg

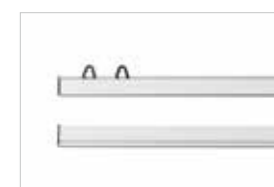

TWIN

40 cm	5907451662236	0,20 kg
60 cm	5907451662243	0,30 kg
85 cm	5907451662250	0,40 kg
100 cm	5907451662267	0,45 kg
120 cm	5907451662274	0,55 kg
150 cm	5907451662281	0,70 kg



VERTICO HANGING FRAMES



- aluminium profile: 25 mm**
 - poster cover with UV-filter protects the printout from fading graphic colours
 - "clip-clap" system - quick and simple assembly and graphics exchange
 - vertical or horizontal assembly
- perfil de aluminio: 25 mm**
 - cubierta para póster con filtro UV que protege la impresión contra la decoloración colores gráficos
 - sistema „clip-clap“ - montaje rápido y sencillo e intercambio de gráficos
 - montaje vertical u horizontal
- profil large (aluminium): 25 mm**
 - changement rapide de l'image grâce aux bords du cadre („clip-clap“)
 - couche avec filtre UV protégeant l'impression de la perte de couleurs
 - montage vertical ou horizontal
- doublesided aluminium frame: 32 mm**
 - mounted on the ceiling
 - simple and elegant design
 - "clip-clap" system - quick and simple graphics assembly and exchange
- perfil de aluminio de doble cara: 32 mm**
 - montado en el techo
 - diseño sencillo y elegante
 - sistema „clip-clap“ - montaje y cambio rápido y sencillo de los gráficos
- cadre en aluminium double face: 32 mm**
 - changement rapide de l'image grâce aux bords du cadre („clip clap“)
 - présentation de l'image des deux côtés
 - câble en acier assurant une suspension sûre du cadre

Recommended media and printing technology for this system: Paper Solvent, UV, Latex

A2	5907451665688	2,1 kg
A1	5907451665671	3,4 kg
B2	5907451665701	2,7 kg
B1	5907451665695	4,3 kg



SNAP FRAMES STANDARD

- aluminium profile: 25 mm**
 - poster cover with UV-filter protects the printout from fading graphic colours
 - "clip-clap" system - quick and simple assembly and graphics exchange
 - vertical or horizontal assembly
- perfil de aluminio: 25 mm**
 - cubierta para póster con filtro UV que protege la impresión contra la decoloración colores gráficos
 - sistema „clip-clap“ - montaje rápido y sencillo e intercambio de gráficos
 - montaje vertical u horizontal
- profil large (aluminium): 25 mm**
 - changement rapide de l'image grâce aux bords du cadre („clip-clap“)
 - couche avec filtre UV protégeant l'impression de la perte de couleurs
 - montage vertical ou horizontal

Recommended media and printing technology for this system: Paper Solvent, UV, Latex

SNAP FRAMES SILVER



A5	5907451662557	0,30 kg
A4	5907451661567	0,45 kg
A3	5907451661574	0,65 kg
A2	5907451661581	1,15 kg
A1	5907451661598	1,90 kg
A0	5907451661604	3,60 kg
B3	5907451662564	0,95 kg
B2	5907451661628	2,00 kg
B1	5907451661611	2,60 kg

SNAP FRAMES BLACK



A4	5907451664872	0,45 kg
A3	5907451664865	0,65 kg
A2	5907451664858	1,15 kg
A1	5907451664841	1,90 kg
B3	5907451665787	0,95 kg
B2	5907451665794	2 kg
B1	5907451665800	2,6 kg

SNAP FRAMES PREMIUM



- **aluminium profile: 32 mm**
- "clip-clap" system – quick and simple assembly and graphics exchange
- vertical or horizontal assembly
- poster cover with UV-filter protects the printout from fading graphic colours

- **perfil de aluminio: 32 mm**
- cubierta para póster con filtro UV que protege la impresión contra la decoloración colores gráficos
- sistema „clip-clap” - montaje rápido y sencillo e intercambio de gráficos
- montaje vertical u horizontal

- **profil large (aluminium): 32 mm**
- changement rapide de l'image grâce aux bords du cadre („clip-clap")
- couche avec filtre UV protégeant l'impression de la perte de couleurs
- montage vertical ou horizontal



A3	5907451664230	1,20 kg
A2	5907451664223	1,85 kg
A1	5907451664216	2,80 kg

Recommended media and printing technology for this system:



MAGNETIC FRAMES

MAGNETIC

- simple and elegant design
 - glossy anti-reflective foil holds the printout with magnetic strips
 - assembly without tools
 - value for money
- diseño sencillo y elegante
 - lámina brillante antirreflectante sujeta la impresión con tiras magnéticas
 - montaje sin herramientas
 - buena relación calidad-precio
- design simple et élégant
 - le film brillant anti-reflet maintient l'impression à l'aide de bandes magnétiques
 - montage sans outils
 - faible coût



A5 (silver)	6956526031285
A4 (silver)	6956526031278
A3 (silver)	6956526031261
A4 (black)	5907451663424
A3 (black)	5907451662670

MAGNETIC REWERS

- front-glued frame
 - double-sided
 - simple and elegant design
 - assembly without tools
- marco encolado por delante
 - doble cara
 - diseño sencillo y elegante
 - montaje sin herramientas
- cadre monté à l'avant
 - design simple et élégant
 - double face
 - assemblage sans outils



A4 (silver)	6956526031513
A3 (silver)	6956526031520
40x60 cm (silver)	6956526031537
A4 (black)	5907451665015



MAGNETIC SAFETY

- magnetic frame in warning version
 - necessary in production halls, warehouses, parking lots and places under special supervision
 - simple and elegant design
 - glossy anti-reflective foil holds the printout with magnetic strips
 - assembly without tools
- marco magnético en versión de advertencia
 - necesario en naves industriales, almacenes, aparcamientos y lugares bajo supervisión especial
 - diseño sencillo y elegante
 - lámina brillante antirreflectante que sujeta la impresión con tiras magnéticas
 - montaje sin herramientas
- cadre magnétique en version d'avertissement
 - indispensable dans les halls de production, les entrepôts, les parkings et les zones de haute sécurité
 - un film brillant anti-reflet maintient l'impression grâce à des bandes magnétiques fixées sur ce film et sur le cadre
 - montage sans outils





A4	5907451663486
A3	5907451663479

Recommended media and printing technology for this system:



DOOR SIGNS

SONIC

- 
 - one of the most popular wall door signs on the market
 - quick assembly
 - popular "clip-clap" system - graphics change takes few seconds
 - anti-reflective film included
 - mounting with fixing bolts or double-sided tape
 - value for money
- 
 - uno de los letreros para puertas de pared más populares del mercado
 - montaje rápido
 - popular sistema „clip-clap“ - el cambio de gráficos se realiza en pocos segundos
 - lámina antirreflectante incluida
 - montaje con tornillos de fijación o cinta adhesiva de doble cara
 - buena relación calidad-precio
- 
 - l'une des plaques de porte les plus populaires sur le marché
 - rapidité de changement de l'étiquette („clip-clap“)
 - film anti-reflet inclus
 - la plaque peut être montée à l'aide des vis incluses dans le kit ou avec du ruban adhésif double face





	
A6	6956526031179
A5	6956526031162
A4	6956526031155

Recommended media and printing technology for this system:



ELITE

- 
 - aspecto muy elegante
 - el más elegido para interiores de estilo moderno
 - el gráfico se puede sustituir desatornillando dos separadores que sujetan dos láminas de plexiglás
 - utilice este sistema si no necesita cambiar los gráficos con frecuencia
- 
 - aspecto muy elegante
 - el más elegido para interiores de estilo moderno
 - el gráfico se puede sustituir desatornillando dos separadores que sujetan dos láminas de plexiglás
 - utilice este sistema si no necesita cambiar los gráficos con frecuencia
- 
 - une élégance exceptionnelle
 - souvent choisi pour les intérieurs modernes
 - pour changer l'étiquette indicative, il suffit de dévisser les entretoises retenant les deux plaques de plexiglas
 - utiliser ce système si vous n'avez pas besoin de modifier les fréquemment les graphiques

	
A6	6956526032121
148x148 mm	6956526032138
A5	6956526032145
A4	6956526032169

Recommended media and printing technology for this system:



GERT

- 
 - modern design
 - classic ash-grey color which fits any interior design
 - graphics may be replaced with a single move, just by opening the plate clips
 - no tools required
- 
 - diseño moderno
 - color gris ceniza clásico que combina con cualquier diseño interior
 - los gráficos se pueden sustituir con un solo movimiento, simplemente abriendo los clips de la placa
 - no se necesitan herramientas
- 
 - série de plaques exceptionnellement élégantes qui se distinguent par leur aspect moderne
 - la couleur cendrée classique convenant à tous les intérieurs
 - vous pouvez changer l'étiquette indicative d'un seul geste et sans aucun outil, en ouvrant les fermoirs pression de la plaque

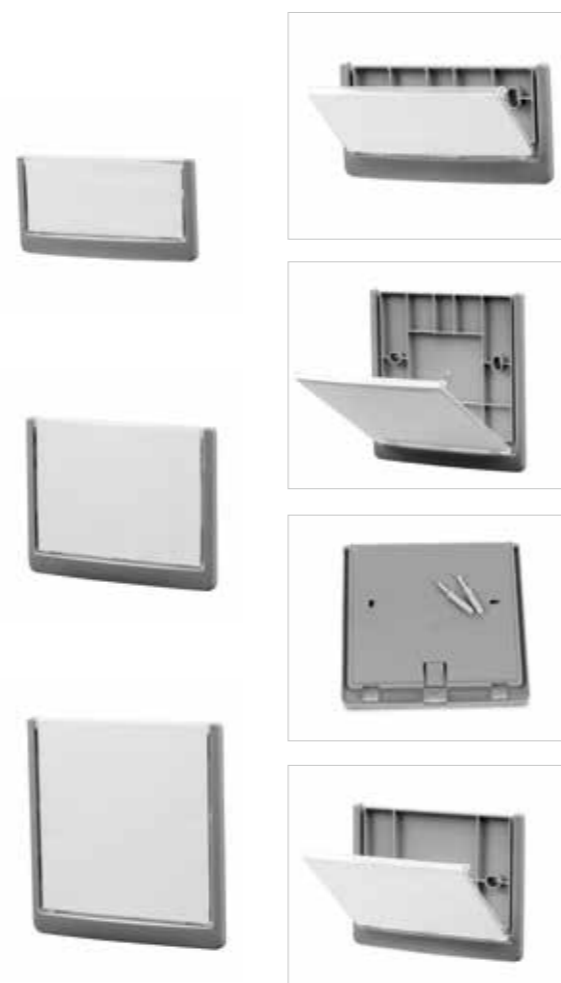



	
149x64 mm	6956526032084
149x105,5 mm	6956526032091
149x148,5 mm	6956526032107

Recommended media and printing technology for this system:



PURO

- 
 - modern look
 - easy content exchange
 - made of a very thick aluminium profile
 - mounting with double-sided tape
- 
 - aspecto moderno
 - fácil intercambio de contenido
 - fabricado con un perfil de aluminio muy grueso
 - montaje con cinta adhesiva de doble cara
- 
 - aspect moderne
 - échange facile du contenu
 - en profilé d'aluminium très épais
 - montage avec du ruban adhésif double face

	
180x50 mm	6956526031711
180x70 mm	6956526031728
210x90 mm	6956526031735

Recommended media and printing technology for this system:



MANTA



- 
 - minimalistic look
 - suitable for interiors designed in bright - Scandinavian style
 - this holder is equipped with a white frame on which front plexiglass pane is installed (with clips)
- 
 - aspecto minimalista
 - adecuado para interiores diseñados en estilo escandinavo luminoso
 - este soporte está equipado con un marco blanco en el que se instala un panel frontal de plexiglás (con clips)
- 
 - aspect minimaliste
 - convient aux intérieurs conçus dans un style lumineux - scandinave
 - ce support est équipé d'un cadre blanc sur lequel est installé
 - la vitre avant en plexiglas est installée (avec des clips)

	
A6	6956526050989
A5	6956526050996
A4	6956526051009

Recommended media and printing technology for this system:



ACRYLIC STANDS CRYSTAL

- 
 - double sided acrylic stand
 - ideal for placing on a table / counter in various public spaces, e.g. restaurants, banks, hotels
 - wide base ensures stability
 - versatile appearance
- 
 - soporte acrílico de doble cara
 - ideal para colocar sobre una mesa o mostrador en diversos espacios públicos, como restaurantes, bancos u hoteles
 - su base ancha garantiza la estabilidad
 - aspecto versátil
- 
 - support acrylique double face
 - idéal pour être placé sur des tables ou des comptoirs dans divers espaces publics, tels que les restaurants, les banques, les hôtels, etc.
 - la large base garantit la stabilité aspect neutre

Recommended media and printing technology for this system:





Paper
Solvent, UV, Latex

	
A7	6956526050132
A6	6956526050156
A5	6956526050163
A4	6956526050170



PLATINUM

- 
 - acrylic stand with a slight angle of inclination
 - minimalistic look
 - ideal for placing on a table / counter in the interiors of various public spaces, e.g. in banks, hotels, corporate receptions, etc.
 - wide base with interesting design guarantees stability
- 
 - soporte acrílico con un ligero ángulo de inclinación
 - aspecto minimalista
 - ideal para colocar sobre una mesa o mostrador en el interior de diversos espacios públicos, por ejemplo, en bancos, hoteles, recepciones corporativas, etc.
 - la base ancha con un diseño interesante garantiza la estabilidad
- 
 - support en acrylique avec un léger angle d'inclinaison
 - design minimaliste
 - idéal pour une utilisation sur les tables/comptoirs dans les lieux publics tels que les banques, les hôtels, les bureaux de réception, etc.
 - la large base au design intéressant garantit la stabilité

Recommended media and printing technology for this system:







Paper
Solvent, UV, Latex

	
A5	6956526053638
A4	6956526053645



VISTA HORIZONTAL

- 
 - heavy acrylic stand with a broad base
 - elegant look
 - horizontal graphic presentation
 - double-sided
- 
 - soporte acrílico pesado con una base ancha
 - aspecto elegante
 - presentación gráfica horizontal
 - doble cara
- 
 - support en acrylique solide avec une large base
 - design exceptionnellement élégant
 - présentation horizontale du contenu
 - double face

	
A6	6956526053775
A5	6956526053768
A4	6956526053751



Recommended media and printing technology for this system:



Paper
Solvent, UV, Latex



VISTA VERTIKAL

- 
 - heavy acrylic stand with a broad base
 - elegant look
 - vertical graphic presentation
 - double-sided
- 
 - soporte acrílico pesado con una base ancha
 - aspecto elegante
 - presentación gráfica vertical
 - doble cara
- 
 - support en acrylique solide avec une large base
 - design exceptionnellement élégant
 - présentation horizontale du contenu
 - double face

	
A6	6956526053737
A5	6956526053720
A4	6956526053713

Recommended media and printing technology for this system:



Paper
Solvent, UV, Latex



ROD SYSTEMS

- popular ROD system for wall to wall hanging adv boards
- made from high quality aluminium
- minimalistic and elegant appearance
- long steel rope (300 cm/400 cm) included
- adjustable steel rope length
- anchors and screws for mounting included

- popular sistema ROD para colgar carteles publicitarios de pared a pared
- fabricado en aluminio de alta calidad
- aspecto minimalista y elegante
- cable de acero largo (300 cm/400 cm) incluido
- longitud del cable de acero ajustable
- anclajes y tornillos para el montaje incluidos

- le système ROD populaire destiné à suspendre les panneaux publicitaires, fabriqué - en aluminium de haute qualité
- design minimaliste et élégant
- long câble en acier inclus (300 cm/400 cm)
- longueur de câble réglable
- chevilles et vis de fixation incluses

WALL TO WALL SYSTEM

PARED-PARED
SYSTÈME DE CÂBLES
MUR-MUR

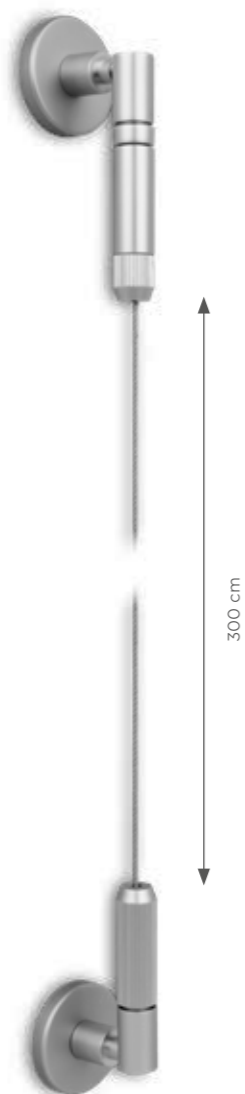

5907451664490 | 0,5 kg | ROD | 300 cm

WALL TO FLOOR/CEILING SYSTEM

PARED-SUELO/TECHO
SYSTÈME DE CÂBLES
MUR-SOL/PLAFOND

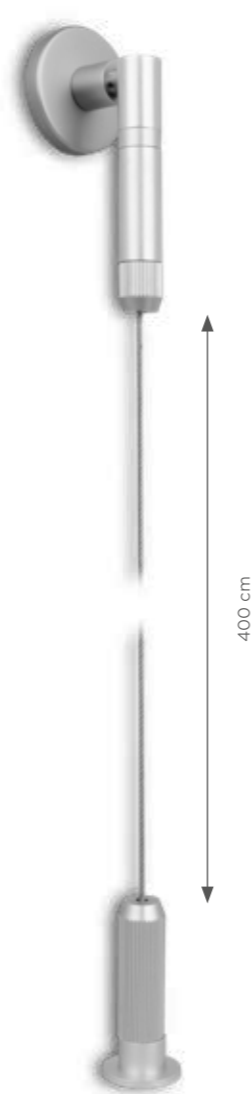

5907451664513 | 0,4 kg | ROD | 400 cm

CEILING TO FLOOR SYSTEM

TECHO-SUELO
SYSTÈME DE CÂBLES
PLAFOND-SOL

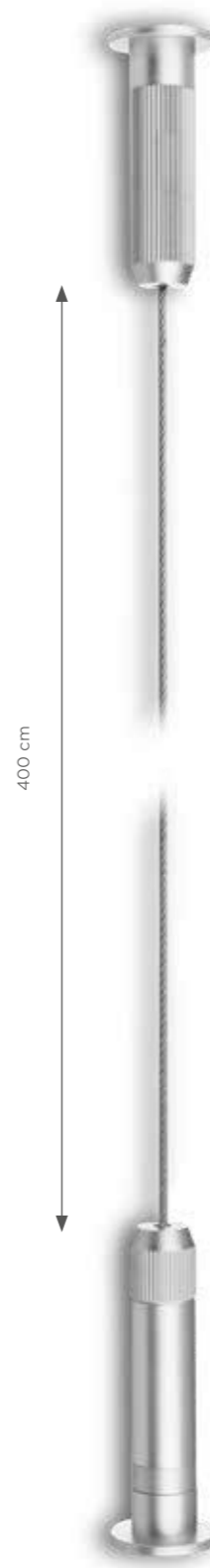

5907451664506 | 0,3 kg | ROD | 400 cm

CEILING TO BOARD SYSTEM

TECHO-TABLERO
SYSTÈME DE CÂBLES
PLAFOND-PANNEAU

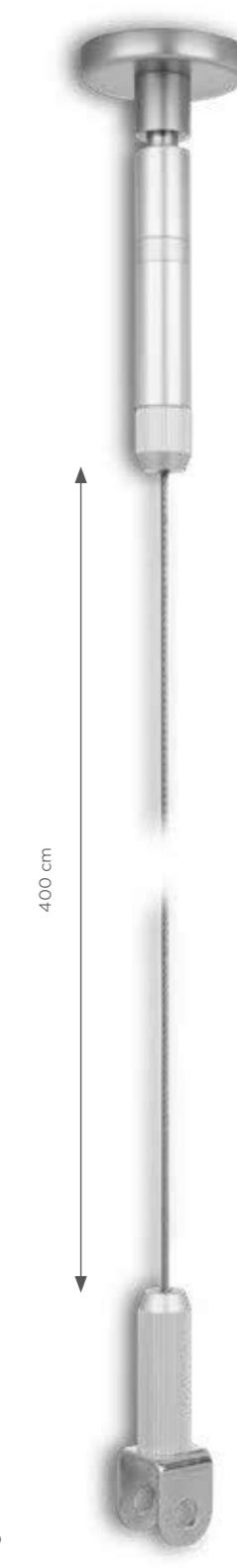

5907451664520 | 0,4 kg | ROD | 400 cm

ACCESSORIES



SINGLE-SIDE BOARD HOLDER

SOPORTE DE TABLERO
- UN LADO
FIXATION DU
PANNEAU
- UNILATÉRALE



5907451664537 0,1 kg

DOUBLE-SIDE BOARD HOLDER

SOPORTE DE TABLERO
- DOBLE CARA
FIXATION DU
PANNEAU
- BILATÉRALE



5907451664544 0,15 kg

STANDOFFS DISTANCIADOR ENTRETOISES



- designed for mounting all types of advertising boards
- made of aluminum
- high quality
- multiple sizes
- two color versions: black mat and silver satin

- diseñado para montar todo tipo de carteles publicitarios
- fabricado en aluminio
- alta calidad
- varios tamaños
- dos versiones de color: negro mate y plata satin

- conçu pour le montage de tous types de panneaux d'affichage
- en aluminium
- de haute qualité
- plusieurs tailles disponibles
- deux versions de couleurs: noir mat et argent satiné

SILVER SATIN



Size	Barcode	Product Code
13x13 mm		5907451664551
13x19 mm		5907451664575
15x20 mm		5907451664599
15x25 mm		5907451664612
19x19 mm		5907451664636
19x25 mm		5907451664650
25x29 mm		5907451664674
25x25 mm		5907451664698

SILVER MAT



Size	Barcode	Product Code
13x13 mm		5907451668108
13x19 mm		5907451668115
15x20 mm		5907451668122
15x25 mm		5907451668139
19x19 mm		5907451668146
19x25 mm		5907451668153
25x19 mm		5907451668160
25x25 mm		5907451668177

BLACK MAT



Size	Barcode	Product Code
13x13 mm		5907451664568
13x19 mm		5907451664582
15x20 mm		5907451664605
15x25 mm		5907451664629
19x19 mm		5907451664643
19x25 mm		5907451664667
25x19 mm		5907451664681
25x25 mm		5907451664704



PAVEMENT SIGNS

AURORA

- aluminium profile: 25 mm
 - double-sided
 - very resistant to weather conditions
 - clip-clap system - quick graphics exchange
 - poster cover with UV-filter protects the printout from fading colours
- The set includes: stand Aurora in a carton box.

- perfil de marco (aluminio): 25 mm
 - doble cara
 - muy resistente a las condiciones climáticas
 - sistema „clip-clap“ - intercambio rápido de gráficos
 - cubierta protectora con filtro UV que protege la impresión contra la decoloración de los colores
- El kit incluye: tablero publicitario Aurora, caja de cartón individual.

- profil large (aluminium): 25 mm
 - recto-verso
 - changement rapide de l'affiche (cadre clic-clac)
 - couverture dotée d'un filtre UV protégeant l'impression de la perte de couleurs
- Le kit comprend: un chevalet stop trottoir Aurora, une boîte en carton individuelle.

Recommended media and printing technology for this system:



AURORA SILVER



A2	5907451662021	6,75 kg
A1	5907451662151	9,00 kg
A0	5907451662144	12,60 kg
B2	5907451662182	5,00 kg
B1	5907451662175	9,20 kg

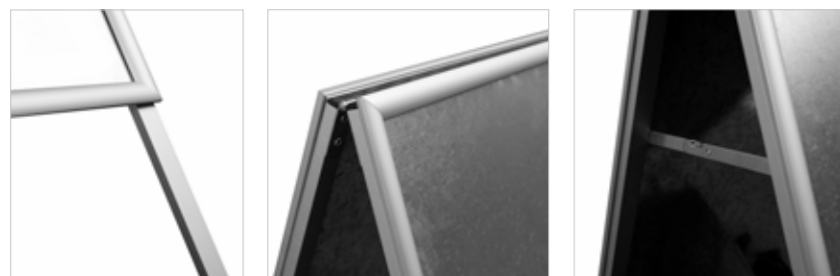

AURORA BLACK

A2	5907451664384	6,75 kg
A1	5907451664377	9,00 kg
A0	5904423600722	21,2 kg

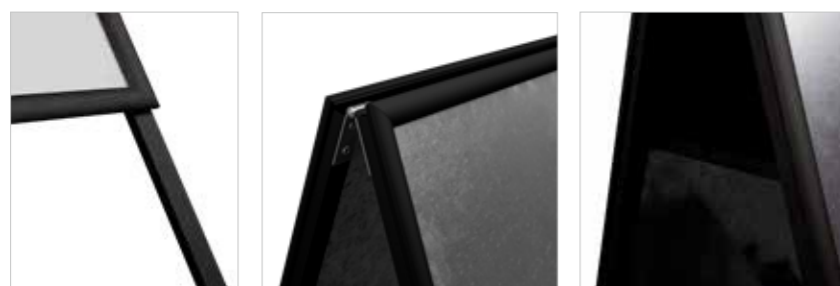

SPIDER



- aluminium profile: 32 mm
 - extremely stable even in strong winds
 - double sided
 - very weather resistant
 - clip-clap system - quick graphics exchange
 - poster cover with UV-filter protects the printout from fading colours
- This set includes: stand Spider in individual box.

- perfil de marci (aluminio): 32 mm
 - extremadamente estable incluso con vientos fuertes
 - doble cara
 - muy resistente a la intemperie
 - sistema „clip-clap“ - cambio rápido de gráficos
 - la cubierta del póster con filtro UV protege la impresión contra la decoloración
- El kit incluye: tablero publicitario Spider, caja de cartón individual.

- profil large (aluminium): 32 mm
 - chevalet stop trottoir très stable (cadre sur ressorts, pieds écartés) très résistant aux intempéries
 - changement rapide de l'affiche (cadre clic-clac)
 - recto-verso
 - couverture dotée d'un filtre UV protégeant l'impression de la perte de couleurs
- Le kit comprend: un chevalet stop trottoir Spider, une boîte en carton individuelle.



A1	5907451662205	8,8 kg

Recommended media and printing technology for this system:



HAMPTON

- **aluminium profile: 32 mm**
- base can be filled with water or sand
- extremely stable even in strong wind
- double sided
- very weather resistant
- clip-clap system – quick graphics exchange
- poster cover with UV-filter protects the printout from fading colours

This set includes: stand Hampton in a carton box.

- **perfil de marco (aluminio): 32 mm**
- la base se puede rellenar con agua o arena
- extremadamente estable incluso con viento fuerte
- doble cara
- muy resistente a la intemperie
- sistema „clip-clap“ – cambio rápido de gráficos
- la cubierta del póster con filtro UV protege la impresión contra la decoloración colores

El kit incluye: tablero publicitario Hampton embalado en dos cajas separadas.

- **profil large (aluminium): 32 mm**
- chevalet stop trottoir très stable (cadre sur ressorts, socle rempli d'eau)
- poignée et roulettes facilitant le transport
- changement rapide de l'affiche (cadre clic-clac)
- recto-verso
- couverture dotée d'un filtre UV protégeant l'impression de la perte de couleurs

Le kit comprend: un chevalet stop trottoir Hampton, une boîte en carton individuelle.

Recommended media and printing technology for this system:



HAMPTON SILVER



A1	5907451662014	15 kg
A0	5907451663554	22 kg
B2	5907451663325	18 kg
B1	5907451663561	13 kg



HAMPTON BLACK



A0	5904423600722	21,2 kg
A1	5907451662199	15 kg
B2	5907451665756	13 kg



HAMPTON PRO

NEW!

- **aluminium profile: 40 mm**
- **enhanced water resistance parameters**
- base can be filled with water or sand
- handle and wheels for easy transport
- extremely stable even in strong wind
- double sided
- clip-clap system – quick graphics exchange
- thick poster cover with UV-filter protects the printout from fading colours

The set includes: stand Hampton Pro in a carton box.

- **perfil de marco (aluminio): 40 mm**
- **parámetros de resistencia al agua mejorados**
- la base se puede rellenar con agua o arena
- extremadamente estable incluso con viento fuerte
- doble cara
- muy resistente a la intemperie
- sistema „clip-clap“ - cambio rápido de gráficos
- la cubierta del póster con filtro UV protege la impresión contra la decoloración colores

El kit incluye: tablero publicitario Hampton Pro embalado en dos cajas separadas.

- **profil large (aluminium): 40 mm**
- **paramètres de résistance à l'eau améliorés**
- la base peut être remplie d'eau ou de sable
- chevalet stop trottoir très stable (cadre sur ressorts, socle rempli d'eau)
- poignée et roulettes facilitant le transport
- changement rapide de l'affiche (cadre clic-clac)
- recto-verso
- couverture dotée d'un filtre UV protégeant l'impression de la perte de couleurs

Le kit comprend: un chevalet stop trottoir Hampton Pro, une boîte en carton individuelle.

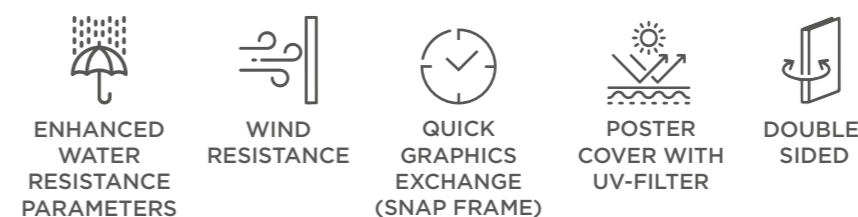

Recommended media and printing technology for this system:



HAMPTON PRO SILVER



A1	5907451666784	17 kg
----	---------------	-------



HAMPTON PRO BLACK

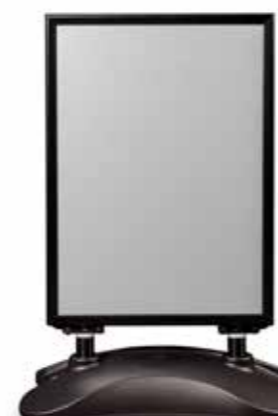

A1	5907451666791	17 kg
----	---------------	-------



SEG

NEW!

- aluminium profile: 25 mm**
 - fabric printout (SEG)
 - practical handle
 - a practical handle allows it to be easily transported

The set includes: SEG sidewalk sign (for self-assembly), individual carton box.
- perfil de marco (aluminio): 25 mm**
 - impresión en tela (SEG)
 - práctica asa
 - una práctica asa permite transportarlo fácilmente

El kit incluye: soporte SEG (para montaje propio), caja de cartón individual.
- profil large (aluminium): 25 mm**
 - impression sur tissu (SEG)
 - poignée pratique
 - une serrure spéciale empêche le produit de se replier accidentellement.

Le kit comprend: chevalet stop trottoir SEG (à monter soi-même), emballage en carton.



Recommended media and printing technology for this system:



Fabric Sublimation printing



5907451660379 4,5 kg

INFO STAND CHROMA

- aluminium profile: 25 mm**
 - double sided poster stand
 - ideal for use in various public spaces
 - easy installation of graphics via a sliding panel
 - stable construction

This set includes: Info stand Chroma in individual box.
- perfil de marco (aluminio): 25 mm**
 - soporte para carteles de doble cara
 - ideal para su uso en diversos espacios públicos
 - fácil instalación de gráficos mediante un panel deslizante
 - construcción estable

El kit incluye: soporte Chroma, caja de cartón individual.
- profil large (aluminium): 25 mm**
 - recto-verso
 - construction en aluminium solide
 - installation facile de graphiques grâce à un panneau coulissant

Le kit comprend: un support Chroma, une boîte en carton individuelle.



5907451664414 5,50 kg

INFO/MENU STAND PULADI

- adjustable angle, transparent frame**
 - stable steel base
 - exchange of graphics by sliding it into an acrylic frame
 - compact size when folded
 - product intended for directions and presenting information

The set includes: Puladi stand, assembly kit with a hex key, individual box.
- Ángulo ajustable, marco transparente**
 - base de acero estable
 - cambio de gráficos deslizando en un marco acrílico
 - tamaño compacto cuando está plegado
 - producto destinado a indicar direcciones y presentar información

El kit incluye: soporte Puladi, kit de montaje con llave Allen, caja de cartón individual.
- angle d'inclinaison du cadre réglable**
 - socle en acier très stable
 - changement rapide de l'image insertion dans le cadre
 - petites dimensions après le pliage
 - le produit est parfait pour tout espace public pour présenter les informations ou indiquer la direction

Le kit comprend: un support Puladi, un jeu de montage avec clé Allen, une boîte en carton individuelle.

	Barcode	Weight	Height
A4	6956526030080	2,2 kg	114 cm
A3	6956526030127	3,3 kg	120 cm

Recommended media and printing technology for this system:

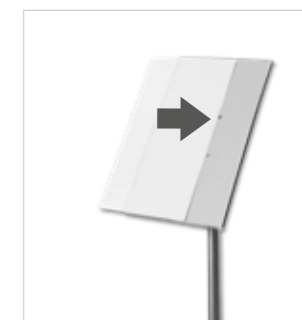

INFO/MENU STAND CLASSIC

- 
aluminium profile: 25 mm
 - base made of steel - very stable
 - adjustable frame angle
 - "clip-clap" system - quick graphics exchange
 - compact size when folded

The set includes: stand Classic, assembly kit with a hex key, individual box.

- 
perfil de marco (aluminio): 25 mm
 - base de acero - muy estable
 - Ángulo del marco ajustable
 - sistema „clip-clap“ - cambio rápido de gráficos
 - tamaño compacto cuando está plegado

El kit incluye: soporte Classic, kit de montaje con llave Allen, caja de cartón individual.

- 
profil large (aluminium): 25 mm
 - angle d'inclinaison du cadre réglable
 - socle en acier très stable
 - changement rapide de l'affiche (cadre clic-clac)
 - petites dimensions après le démontage

Le kit comprend: un support Classic, un jeu de montage avec clé Allen, une boîte en carton individuelle.

			
A4	6956526030257	2,4 kg	111 cm
A3	6956526030264	3,5 kg	115 cm

Recommended media and printing technology for this system:



INFO/MENU STAND PREMIUM

- 
aluminium profile: 25 mm
 - base made of iron
 - very elegant info stand
 - designed, among others for restaurant menu, directions, presentation of information boards etc.
 - clip-clap system - quick graphics exchange
 - the frame can be positioned vertically or horizontally

This set includes: stand Premium stand in a carton box.

- 
perfil de marco (aluminio): 25 mm
 - base de hierro
 - soporte informativo muy elegante
 - diseñado, entre otros, para restaurantes menú, indicaciones, presentación, de paneles informativos etc.
 - sistema „clip-clap“ - cambio rápido de gráficos
 - el marco se puede colocar en vertical o en horizontal

El kit incluye: soporte Premium, caja de cartón individual.

- 
profil large (aluminium): 25 mm
 - design élégant
 - socle en fer
 - possibilité de positionner le cadre verticalement ou horizontalement
 - changement rapide de l'image à l'aide des bords du cadre (clic-clac)
 - destiné entre autres: pour afficher les menus de restaurants, indiquer les directions, présenter les plaques d'information, etc.

Le kit comprend: un support Premium, une boîte en carton individuelle.

Recommended media and printing technology for this system:





PREMIUM SILVER



PREMIUM BLACK



			
A3	5907451664407	4,70 kg	126 cm
A2	5907451664391	5,00 kg	140 cm

			
A4	5907451667590	4 kg	125 cm
A3	5907451664438	4,70 kg	126 cm
A2	5907451664421	5,00 kg	140 cm

INFO/MENU STAND STANDARD

- 
aluminum profile: 25 mm
 - very elegant info stand
 - designed, among others for restaurant menu, directions, presentation of information boards etc.
 - clip-clap system - quick graphics exchange
 - the frame can be positioned vertically or horizontally
 - base made of iron

This set includes: stand Standard in a carton box.

- 
perfil de marco (aluminio): 25 mm
 - soporte informativo muy elegante
 - diseñado, entre otros, para menús de restaurantes, indicaciones, presentación de información, tableros, etc.
 - sistema „clip-clap“ - cambio rápido de gráficos
 - el marco se puede colocar en posición vertical u horizontal
 - base de hierro

El kit incluye: soporte Standard, caja de cartón individual.

- 
profil large (aluminium): 25 mm
 - socle en fer
 - possibilité de positionner le cadre verticalement ou horizontalement
 - changement rapide de l'image à l'aide des bords du cadre (clic-clac)
 - destiné entre autres: pour afficher les menus de restaurants, indiquer les directions, présenter les plaques d'information, etc.

Le kit comprend: un support Standard, une boîte en carton individuelle.

			
A4	5907451662106	3,70 kg	116 cm
A3	5907451664322	4,30 kg	121 cm

Recommended media and printing technology for this system:



METAL EASEL



- made of black powder painted metal
 - small size after folding
 - elegant case included
- The set includes: easel, transport case.

- fabricado en metal pintado con polvo negro
 - tamaño reducido una vez plegado
 - elegante estuche incluido
- El kit incluye: caballete plegable, elegante maletín.

- en métal peint par poudrage noir
 - petite taille après pliage
 - élégante mallette incluse
- Le kit comprend: un chevalet pliable, un étui élégant.



5907451663578



1,2 kg



WOODEN PRODUCTS

CHALKBOARD SIGNS CLASSIC

- profile: 35 mm
- elegant wooden frame
- versatile design-will fit into any space
- writing surface made of chalkboard
- ideal for restaurants and retail spaces

- perfil: 35 mm
- elegante marco de madera
- diseño versátil - se adapta a cualquier espacio
- superficie de escritura de pizarra
- ideal para restaurantes y espacios comerciales

- profil large: 35 mm
- cadre élégant en bois
- design polyvalent - s'adapte à tous les espaces
- la surface d'écriture sous forme de tableau noir est idéale
- pour les établissements de restauration et les espaces commerciaux

CLASSIC



S	51x90 cm	5907451669808	3,5 kg
M	60x100 cm	5907451664780	4 kg
L	61x118 cm	5907451669785	5,5 kg
XL	72x160 cm	5907451669778	9 kg

CLASSIC NATURAL



S	51x90 cm	5907451667484	3,5 kg
M	60x100 cm	5907451667347	4 kg
L	61x118 cm	5907451668535	5,5 kg
XL	72x160 cm	5907451667491	9 kg

CLASSIC RED



S	51x90 cm	5907451667736	3,5 kg
M	60x100 cm	5907451667743	3,5 kg
L	61x118 cm	5907451667750	5,5 kg
XL	72x160 cm	5907451667767	9 kg

CLASSIC BLACK



S	51x90 cm	5907451667668	3,5 kg
M	60x100 cm	5907451667330	3,5 kg
L	61x118 cm	5907451667651	5,5 kg
XL	72x160 cm	5907451667729	9 kg

CLASSIC GREEN



S	51x90 cm	5907451668269	3,5 kg
M	60x100 cm	5907451668276	3,5 kg
L	61x118 cm	5907451668283	5,5 kg
XL	72x160 cm	5907451668290	9 kg

CHALKBOARD SIGN PRO WATERPROOF

- profile: 60 mm**
 - weather resistant due to varnish coating
 - very durable construction
 - stability ensured by the weight - 21 kg
 - silver chain securing the legs

- perfil: 60 mm**
 - resistente a la intemperie gracias a su revestimiento de barniz
 - construcción muy duradera
 - estabilidad garantizada por su peso - 21 kg
 - cadena plateada que asegura las patas

- profil large: 60 mm**
 - résistant aux intempéries grâce à une couche de vernis
 - production européenne
 - stabilité assurée par le poids - 21 kg
 - chaîne argentée fixant les pieds



LIQUID CHALK MARKERS

- A set of 8 markers with liquid chalk for chalkboard writing. A perfect replacement for dusty chalk. The set consists of 8 markers in following vivid colours: white, yellow, orange, pink, red, light blue, violet, green. The markers have a dual, reversible chisel: round and flat. This enables writing in bold. Markers are non-toxic, unscented, and easily removed with water.

- Juego de 8 rotuladores con tiza líquida para escribir en pizarras. El sustituto perfecto de la tiza polvorienta. El juego consta de 8 rotuladores en los siguientes colores vivos: blanco, amarillo, naranja, rosa, rojo, azul claro, violeta y verde. Los rotuladores tienen una punta doble reversible: redonda y plana. Esto permite escribir con trazos gruesos. Los rotuladores no son tóxicos, no tienen olor y se eliminan fácilmente con agua.

- Lot de 8 marqueurs à craie liquide, pour écrire sur les tableaux noirs. Une excellente alternative à la craie traditionnelle poussiéreuse. Lot de 8 marqueurs aux couleurs vives : blanc, jaune, orange, rose, rouge, bleu, violet, vert. Chaque marqueur est doté d'une pointe à double face : ronde et plate. Cela permet d'écrire des lignes de différentes largeurs. Les marqueurs sont inodores et non toxiques et facilement lavables à l'eau.



5907451665480

CHALKBOARDS

PIZARRA DE TIZA TABLEAUX À CRAIE



- Classic chalkboards in wooden frames. **The frame profile is 3,5 cm.** The writing, black space is made of solid, durable HDF board. Chalk and liquid chalk markers can be used for writing on the HDF board. The chalkboards can be presented vertically and horizontally.

- Pizarras clásicas con marcos de madera. **El perfil del marco es de 3,5 cm.** La superficie para escribir, de color negro, está fabricada con tablero HDF sólido y duradero. Se puede escribir en el tablero HDF con tizas y rotuladores de tiza líquida. Las pizarras se pueden colocar en vertical y en horizontal.

- Tableau noir à craie avec surface d'écriture en panneau HDF résistant, recouvert d'un vernis spécial. **Le profil du cadre est de 3,5 cm.** Vous pouvez écrire au tableau à la craie ou avec les marqueurs craie liquide. Le tableau peut être accroché verticalement ou horizontalement.



Frame size	Blackboard size	Barcode	Weight
47x60 cm	40x53 cm	5907451669686	1,5 kg
47x79 cm	40x72 cm	5907451669679	1,8 kg
60x87 cm	53x80 cm	5907451669662	2,1 kg
80x100 cm	73x93 cm	5907451669655	3 kg

TABLE STANDS

SOPORTE DE PIZARRA SUPPORTS À CRAIE



- Double sided tabletop chalkboards in 3 sizes. The bottom is a brown wooden panel. Classic, plain look ensures fine presenting the stand in various spaces. The black board is made of durable HDF plate, that makes it possible to write with chalk or liquid chalk markers on it.

- Pizarras de mesa de doble cara en 3 tamaños. La parte inferior es un panel de madera marrón. Su aspecto clásico y sencillo garantiza una buena presentación del soporte en diversos espacios. La pizarra negra está fabricada con un panel HDF resistente, lo que permite escribir con tizas o rotuladores de tiza líquida.

- Un support à craie double face pour présenter les informations est idéal pour être placé sur une table/un comptoir dans divers espaces publics, par exemple dans les restaurants, les banques, les hôtels, etc. La surface à craie (HDF résistant) permet un changement facile et rapide des informations notées. Le socle en bois garantit la stabilité du produit et son aspect élégant.



	Blackboard size	Barcode
A6	10x15 cm	5907451669624
A5	15x21 cm	5907451669631
A4	21x30 cm	5907451669648

EASEL

 A wooden easel will be perfect as a display in stores, galleries or restaurants. Classic look and stable construction are the distinctive features of this product. The easel has an adjustable tilt angle. The bottom shelf and upper handle ensure reliable hold of the frame or picture.

 Un caballete de madera será perfecto como expositor en tiendas, galerías o restaurantes. El aspecto clásico y la construcción estable son las características distintivas de este producto. El caballete tiene un ángulo de inclinación ajustable. El estante inferior y el asa superior garantizan una sujeción fiable del marco o del cuadro.

 Chevalet en bois qui possède une structure très stable et légère. L'étagère inférieure et la poignée supérieure assurent un maintien solide du cadre ou du tableau. Une grande amplitude de réglage permet la présentation de tableaux de différentes tailles. Le chevalet peut être plié rapidement et sans effort ce qui facilite son rangement et son transport. Le produit constitue une solution idéale pour les personnes qui recherchent un présentoir classique et élégant pour un magasin, une galerie ou un restaurant.

EASEL NATURAL



5907451669716

Chalkboard not included

EASEL MAHOGANY



5907451669143

Chalkboard not included

EASEL WHITE



5907451668979

Chalkboard not included

EASEL BLACK



5907451668986

Chalkboard not included



LOUNGERS

WOODEN LOUNGER

(4 PIECES OR FOR SELF-ASSEMBLY)



- sturdy pine construction
 - 3-stage backrest adjustment
 - high load capacity (120 kg)
 - special locking elements prevent the lounger from uncontrolled folding
- The product meets PN-EN 581-1:2017-04 oraz PN-EN 581 1-2:2016-02 requirements.

- estructura de pino resistente
- ajuste del respaldo en 3 posiciones
- capacidad de carga de hasta 120 kg
- elementos de bloqueo especiales que evitan el plegado incontrolado de la tumbona

El producto cumple los requisitos de las normas PN-EN 581-1:2017-04 y PN-EN 581 1-2:2016-02.

- la construction solide en bois de pin
- réglage du dossier en 3 étapes
- capacité de charge jusqu'à 120 kg
- des éléments de verrouillage spéciaux empêchent le pliage incontrôlé de la chaise longue

Le produit répond aux exigences des normes PN-EN 581-1:2017-04 et PN-EN 581 1-2:2016-02. Vous trouverez le rapport de test ci-dessous.



Lounger material not included



4 pieces	5907451668788	2,5 kg / 1 piece
self-assembly	5907451668795	2,5 kg

ALUMINIUM LOUNGER

NEW!

- 4-stage backrest adjustment
 - high load capacity to 130 kg
 - solid, aluminium construction
- The set includes: lounger, individual carton box.

- ajuste del respaldo en 4 posiciones
 - gran capacidad de carga: hasta 130 kg
 - estructura sólida de aluminio
- El conjunto incluye: tumbona, caja de carton individual.

- réglage du dossier en 4 étapes
 - capacité de charge jusqu'à 130 kg
 - structure en aluminium
- Le kit comprend: une chaise, une boîte en carton individuelle.



Lounger material not included



	5907451660386	3,2 kg



QUEUE BARRIER

PREMIUM BARRIER

High quality barrier posts with a tape winding system. The post weight was raised to 7.5 kg, and the tape extended to 225 cm. The winding head is integrated with the post, and its replacement is very simple and quick. The tape used in the head is a car seat belt, extremely strong and durable (red colour - exchangeable).

Postes de barrera de alta calidad con un sistema de enrollado de cinta. El peso del poste se ha aumentado a 7,5 kg y la cinta se ha extendido hasta 225 cm. El cabezal de enrollado está integrado en el poste y su sustitución es muy sencilla y rápida. La cinta utilizada en el cabezal es un cinturón de seguridad de coche, extremadamente resistente y duradero (color rojo, intercambiable).

Poteaux de barrière de haute qualité avec enrouleur de sangle automatique. Le poids du poteau a été augmenté jusqu'à 7,5 kg et la sangle a été rallongée pour atteindre 225 cm. Grâce à son poids élevé, même avec une sangle aussi longue, le poteau reste très stable. L'enrouleur de sangle est intégré au poteau et son remplacement est très simple et rapide. La sangle utilisée dans l'enrouleur est une ceinture de sécurité de voiture. Le matériau est exceptionnellement solide et durable et il ne s'effilochera jamais.

PREMIUM BLACK



PREMIUM CHROME



PREMIUM WHITE



REPLACEMENT HEADS

CABEZAL DE RECAMBIO
ÉCHANGE DE TÊTES
CONTRE DES POTEAUX



HOTEL BARRIER

Hotel barrier well known in many markets in the two most popular colors: gold and silver. Extremely stable, high quality. It will not only be a system to control people, but also an interior decoration for restaurants, clubs or hotels.

Barrera de hotel muy conocida en muchos mercados, disponible en los dos colores más populares: dorado y plateado. Extremadamente estable y de alta calidad. No solo será un sistema para controlar el paso de personas, sino también un elemento decorativo para restaurantes, clubes u hoteles.

Poteaux cordon d'hôtel bien connus sur plusieurs marchés, disponibles dans deux des couleurs les plus populaires : or et argent. Extrêmement stables et de haute qualité. Ils ne seront pas seulement un élément de la gestion du flux de personnes, mais aussi une décoration intérieure pour les restaurants, les clubs ou les hôtels.



ROYAL CHROME

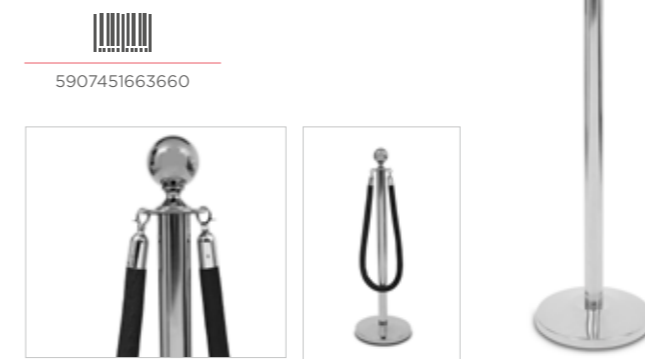

MODERN CHROME

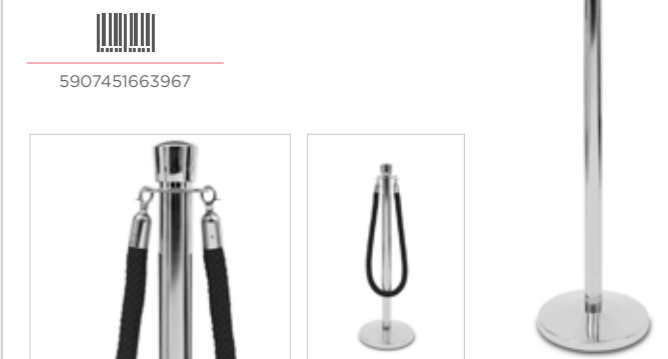

ROYAL GOLD

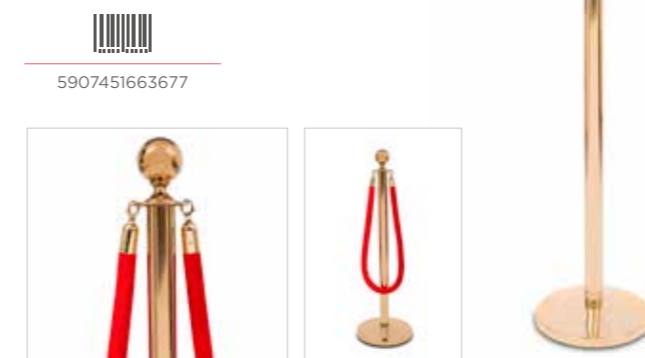

MODERN GOLD

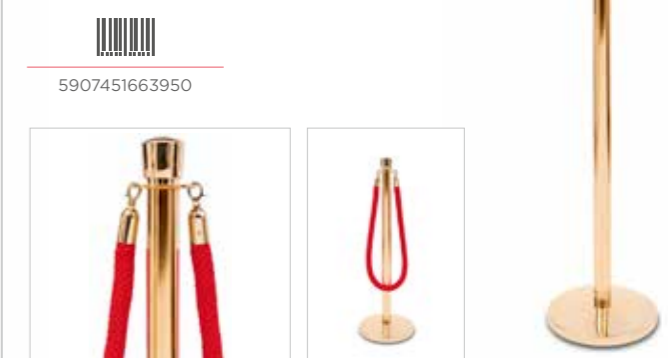

VELVET BORDER

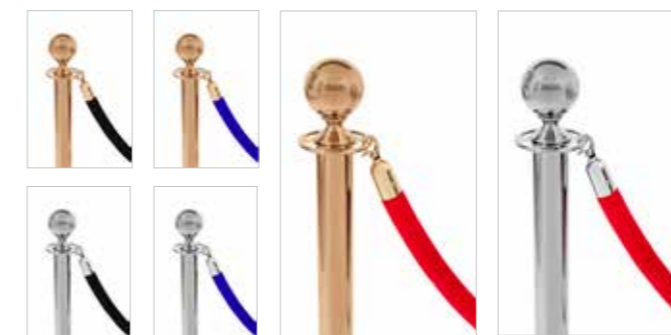

Borders available with silver or gold claps.
Bordes disponibles con cierres plateados o dorados.
Les bordures sont disponibles avec des claps argentés ou dorés.

LACED BORDER

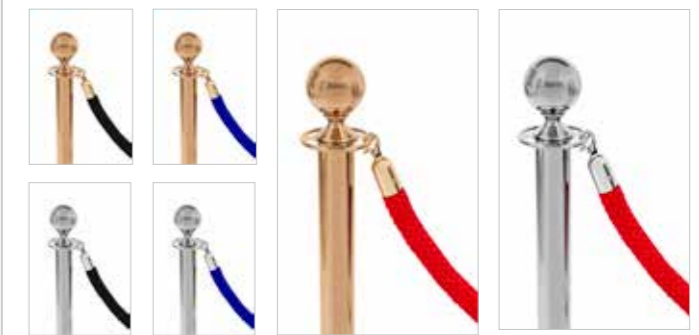

BARRIER POST INFO FRAME

MARCO PARA POSTE
PORTE-AFFICHES POUR LES POTEAUX

 Double-sided A4 information frame applied on the top of barrier post. Available in two colors: chrome and black mat.

 Marco informativo A4 de doble cara aplicado en la parte superior del poste de barrera. Disponible en dos colores: cromado y negro mate.

 Panneau d'information double face au format A4, fixé sur un poteau de barrière.

INFO FRAME CHROME



5907451662403

INFO FRAME BLACK



5907451662397

WALL MOUNTED HEAD

WANDBASE
SUPPORT MURAL

 A belt in another colour is available by purchasing a replacement head in our store.

 Un cinturón de otro color está disponible comprando un repuesto Entra en nuestra tienda.

 Support mural avec enrouleur pour rétracter la sangle. Il sera utile dans les endroits où il n'y a pas assez d'espace pour placer des poteaux. Vous pouvez remplacer la couleur de la sangle en achetant une tête de remplacement dans notre magasin.



black 5907451665053

red 5907451663318



FLAG POLES

STANDARD POLE

One pole many shapes:
(Example shapes)



- one pole - many shapes
- low cost pole
- quick assembly
- aluminium + fiberglass
- fits to all types of our bases

This set includes: Standard pole and taffeta sack.

- 1 mástil - múltiples formas
- mástil de bajo coste
- montaje rápido
- aluminio + fibra de vidrio
- se adapta a todos nuestros tipos de bases

Este conjunto incluye: mástil Standard y saco de tafetán.

- construction en aluminium et en fibre de verre
- un mât - plusieurs formes
- installation rapide
- prix bas
- s'adapte à tous les types de bases

Le kit comprend: un mât Standard, un sac en polyester.

S	5907451662298	0,40 kg	290 cm
M	5907451662304	0,50 kg	350 cm
L	5907451662311	0,60 kg	450 cm
XL	5907451662328	0,80 kg	550 cm

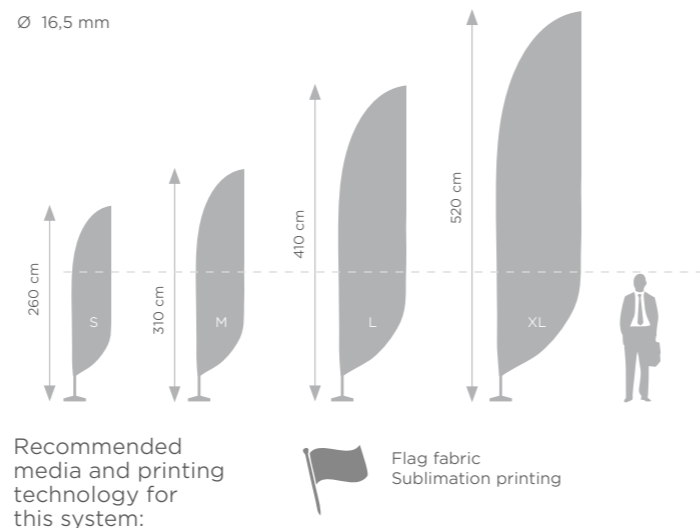

STANDARD PLUS POLE

One pole many shapes:
(Example shapes)



FULL FIBERGLASS



STRENGTH AND DURABILITY

- full fiberglass
- one pole - many shapes
- quick assembly
- fits to all types of our bases

This set includes: Standard Plus pole, a polyester bag.

- fibra de vidrio completa
- 1 mástil - múltiples formas
- ensamble rápido
- se adapta a todo tipo de nuestras bases

Este set incluye: mástil Standard Plus, bolsa de poliéster.

- construction en fibre de verre
- un mât - plusieurs formes
- montage rapide
- convient à tous les types de nos bases

Le kit comprend: un mât Standard Plus, un sac en polyester.

S	5904423600654	0,40 kg	290 cm
M	5904423600661	0,50 kg	340 cm
L	5904423600678	0,60 kg	450 cm
XL	5904423600685	0,80 kg	550 cm

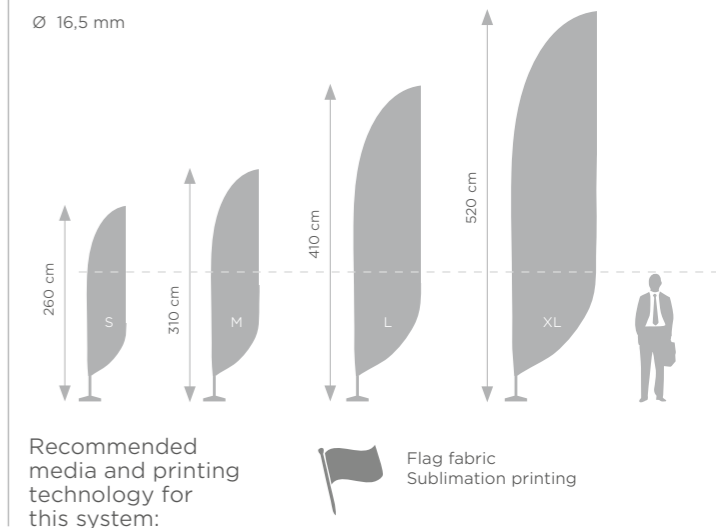
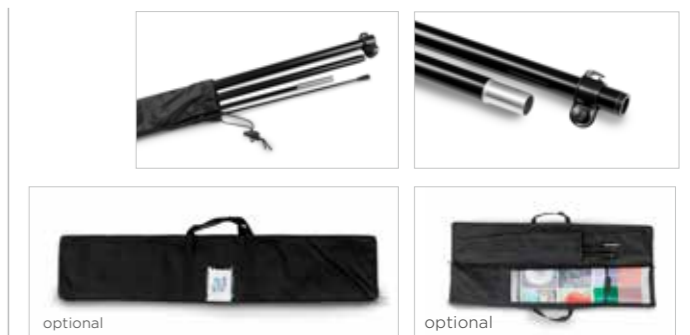

PRO POLE

One pole many shapes:
(Example shapes)



FULL FIBERGLASS



STRENGTH AND DURABILITY

- one pole - many shapes
- mast made entirely of fiberglass
- high quality
- quick assembly
- fits to all types of our bases

This set includes: PRO pole and taffeta sack.

- fibra de vidrio completa
- 1 mastil - multiples formas
- alta calidad
- montaje rápido
- se adapta a todo tipo de nuestras bases

El kit contiene: mástil PRO, bolsa de poliéster.

- construction en fibre de verre
- haute qualité
- un mât - plusieurs formes
- assemblage rapide
- s'adapte à tous les types de bases

Le kit comprend: un mât PRO, un sac en polyester.

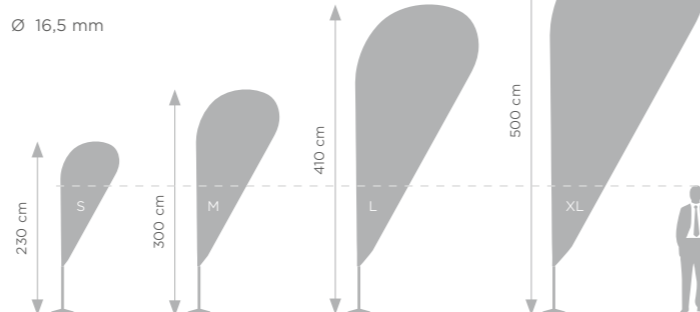
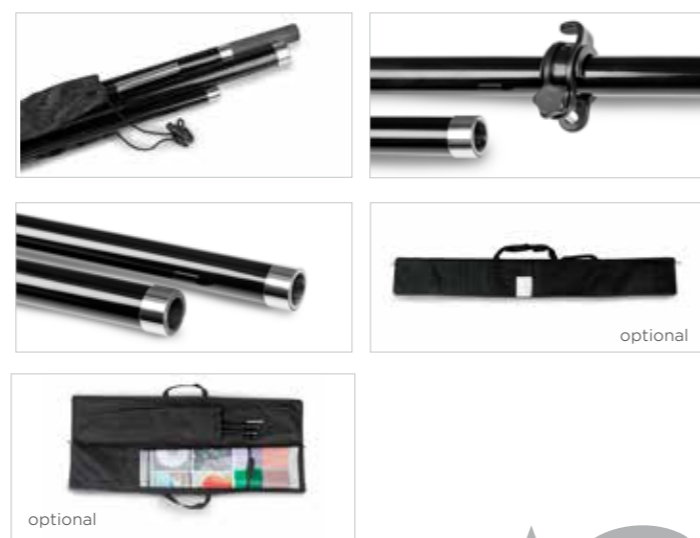

Recommended media and printing technology for this system:



	Barcode	Weight	Height
S	5907451662335	0,50 kg	290 cm
M	5907451662342	0,60 kg	340 cm
L	5907451662359	0,70 kg	450 cm
XL	5907451662366	0,95 kg	560 cm

H POLES

- large advertising space
- even in the absence of wind
- quick and easy assembly
- fits to all kinds of our bases
- full aluminium

This set includes: H pole and taffeta sack.

- gran espacio publicitario
- incluso en ausencia de viento
- montaje rápido y sencillo
- se adapta a todo tipo de nuestra bases
- aluminium completo

El kit contiene: mástil H, bolsa de poliéster.

- grande surface publicitaire
- présentation de l'image imprimée même en l'absence de vent
- montage simple et rapide
- s'adapte à tous les types de bases
- construction en aluminium

Le kit comprend: un mât H, un sac en polyester.

Recommended media and printing technology for this system:

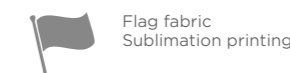

	Barcode	Weight
S	5907451663271	0,80 kg
M	5907451662441	0,90 kg
L	5907451663288	1,20 kg

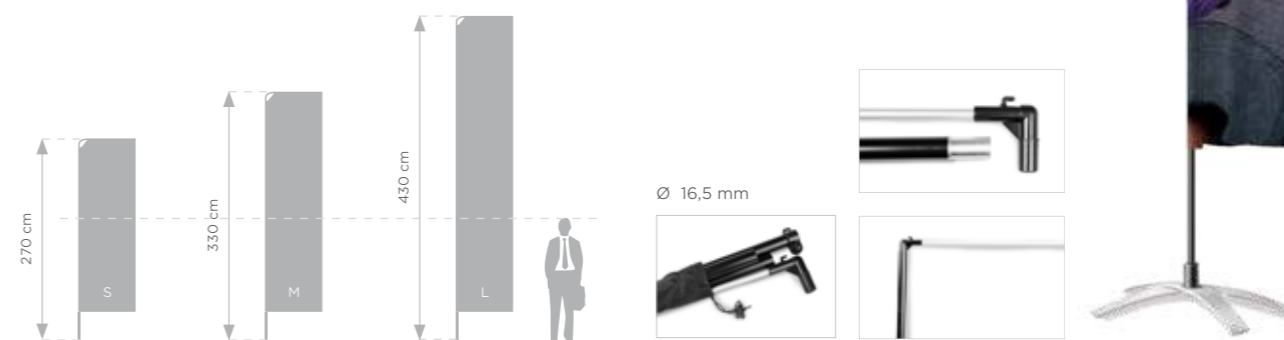

AVENUE

- Great for parking in shopping centers, car dealerships, alleys and city promenades. This set includes: upper and lower double pole, clamps, rubber pads, zips to protect flag/banner.

- Ideal para aparcar en centros comerciales, concesionarios de coches, callejones y paseos de la ciudad. Este set incluye: doble polo superior e inferior, abrazaderas, almohadillas de goma, cremalleras para proteger mástil/estandarte.

- Ce produit devient de plus en plus populaire, notamment pour l'utilisation dans les parkings des centres commerciaux, chez les concessionnaires automobiles, sur les avenues et les promenades urbaines. Le kit comprend: une potence supérieure et inférieure, des pinces, des tampons en caoutchouc, des fermetures éclair pour protéger le drapeau/la bannière.

Recommended media and printing technology for this system:

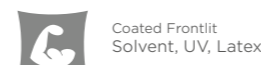
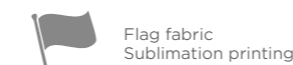

	Barcode	Height
Single sided	5907451663523	66 cm
Double sided	5907451663530	66 cm
Single sided	5907451667705	80 cm
Double sided	5907451667712	80 cm

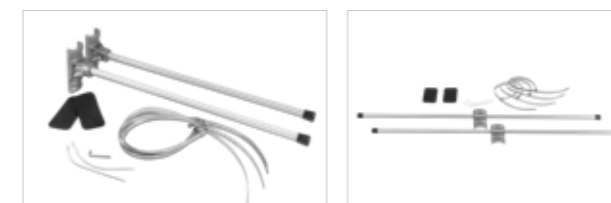

Ø 16,5 mm



TUBE FEATHER FLAGPOLE

NEW!

- exceptionally strong construction
- entirely of aluminium
- flag pole compatible with all bases in our product range
- available in a string bag or zip bag

The set includes: tube flag pole feather, string bag/zip bag.

- construcción excepcionalmente resistente
- completamente de aluminio
- mástil de bandera compatible con todas las bases de nuestra gama de productos
- disponibles en bolsa de corda o bolsa con cremallera

El set incluye: mástil pluma, bolsa de cuerda/bolsa con cremallera.

- construction exceptionnellement solide
- entièrement en aluminium
- mât de drapeau compatible avec toutes les bases de notre gamme de produits
- disponibles dans un sac à ficelle ou un sac zippé

Le kit comprend: un mât Plume, un housse en polyester/un sac.

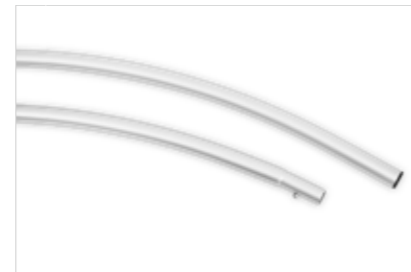

S (string bag)	5907451665930	0,70 kg	265 cm
M (string bag)	5907451665947	0,90 kg	340 cm
L (string bag)	5907451665954	1,15 kg	435 cm
S (zip bag)	5907451665497	0,70 kg	265 cm
M (zip bag)	5907451665503	0,90 kg	340 cm
L (zip bag)	5907451665510	1,15 kg	435 cm

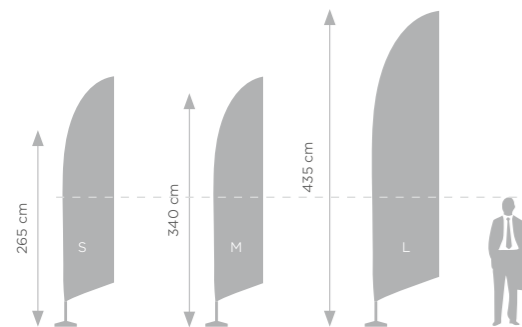

Ø 16,5 mm

Recommended media and printing technology for this system:



TUBE H FLAGPOLE

NEW!

- exceptionally strong construction
- entirely of aluminium
- flag pole compatible with all bases in our product range
- available in a string bag or zip bag

The set includes: tube flag pole H, string bag/zip bag.

- construcción excepcionalmente resistente
- completamente de aluminio
- mástil de bandera compatible con todas las bases de nuestra gama de productos
- disponibles en bolsa de corda o bolsa con cremallera

El set incluye: mástil H, bolsa de cuerda/bolsa con cremallera.

- construction exceptionnellement solide
- entièrement en aluminium
- mât de drapeau compatible avec toutes les bases de notre gamme de produits
- disponibles dans un sac à ficelle ou un sac zippé

Le kit comprend: un mât H, un housse en polyester/un sac.

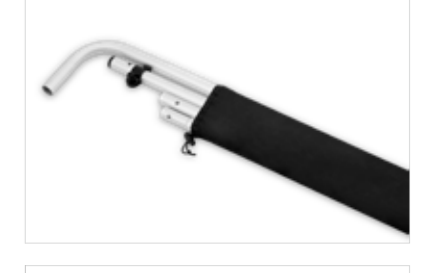

S (string bag)	5907451667774	1,1 kg	305 cm
M (string bag)	5907451667781	1,3 kg	375 cm
L (string bag)	5907451667798	1,4 kg	415 cm
S (zip bag)	5907451665527	1,1 kg	305 cm
M (zip bag)	5907451665534	1,3 kg	375 cm
L (zip bag)	5907451665541	1,4 kg	415 cm

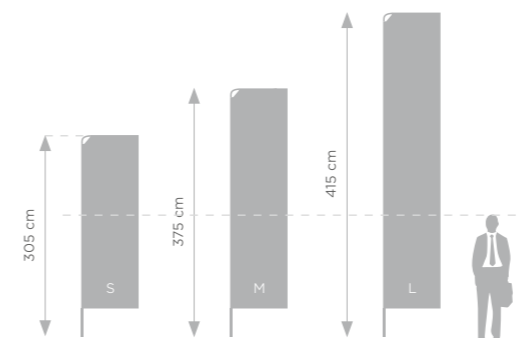

Ø 16,5 mm

Recommended media and printing technology for this system:



POLE BASE

PLATE

PLACA
PLATINE

- square plate made of heavy cast iron
- perfect base and stabilization for every flag
- base mounted to the ground using pins
- hollow handle makes it easy to carry
- placa cuadrada hecha de hierro fundido pesado
- base perfecta y estabilización para cada mástil
- la base se monta a tierra mediante pasadores
- el mango hueco facilita su transporte
- plaque carrée en fonte lourde
- base et stabilisation idéales pour tout drapeau
- base fixée au sol à l'aide d'épingles
- poignée creuse pour faciliter le transport

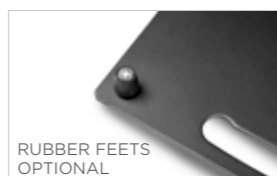

RUBBER FEETS
OPTIONAL

Weight	Barcode	Dimensions
4 kg	5907451661765	30x30 cm
6 kg	5907451661772	35x35 cm
8 kg	5907451661789	39x39 cm
12 kg	5907451661796	48x48 cm

Pin Ø 16,5 mm

RUBBER BASE WITH ROTATOR

NEW!

BASE DE GOMA CON ROTADOR
BASE EN CAOUTCHOUC AVEC ROTATEUR

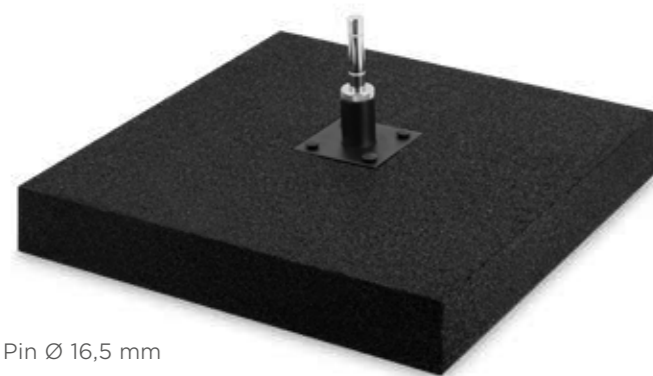

Pin Ø 16,5 mm

- very heavy rubber base with stainless steel rotator
- the rotator is compatible with all flag poles in our offer
- base de goma muy pesada con rotador de acero inoxidable
- el rotador es compatible con todos los mástiles de bandera de nuestra oferta
- base en caoutchouc très lourde avec rotateur en acier inoxydable
- le rotateur est compatible avec tous les mâts de drapeau de notre gamme

Barcode	Weight
5904423600821	10 kg
5904423601071	12 kg
5904423600838	15 kg
5907451664803	19 kg

TWISTER



Pin Ø 16,5 mm

- An accessory that allows you to create a unique advertising medium using two poles.
- Accesorio que permite crear un medio publicitario único utilizando dos mástiles.
- Accessoire permettant de créer un support publicitaire unique à l'aide de deux mâts.

Barcode	Weight
5907451662410	0,8 kg

FLAT CROSS

BASE EN CRUZ PLANA
PIED EN CROIX PLAT

- for use on flat and soft grounds
- can be attached to the ground with pins
- can be additionally loaded with a water bag
- para uso en suelos planos y blandos
- puede fijarse a tierra con pasadores
- además, se puede cargar con una bolsa de agua
- a utiliser sur sol plat ou meuble
- elle peut être fixée avec des broches
- la base peut aussi être lestée avec une charge roue d'eau



Barcode	Weight	Dimensions	Pin
5907451661857	2,3 kg	60x53 cm	Pin Ø 16,5 mm

TUBE CROSS

BASE EN CRUZ
PIED EN CROIX

- elegant base designed mainly for indoor interiors
- can be additionally loaded with a water bag
- diseño de base elegante principalmente para interiores interiores
- puede cargarse además con una bolsa de agua
- base métallique élégante pour mâts de drapeau
- à l'extérieur, lestez la base avec une charge roue d'eau pour augmenter la stabilité du système

TUBE CROSS GREY



Barcode	Weight	Dimensions	Pin
5907451661864	1,4 kg	82x70 cm	Pin Ø 16,5 mm

TUBE CROSS BLACK



Barcode	Weight	Dimensions	Pin
5907451669044	1,4 kg	82x70 cm	Pin Ø 16,5 mm

WATER BAG

SACO DE AGUA
CHARGE ROUE D'EAU

- additional load
- after filled with water, it reaches a weight of up to 10 kg
- particularly suitable for high poles.
- carga adicional
- tras llenarse de agua, alcanza un peso de hasta 10 kg
- especialmente adecuado para mástil altos
- charge roue d'eau ronde utilisée pour lester les bases
- lorsqu'elle est remplie d'eau, elle peut peser jusqu'à 10 kg
- surtout utile pour fixer des drapeaux hauts



Barcode	Weight	Dimensions
5907451661871	0,5 kg	Ø 50 cm

Ø 50 mm



POLE BASE

WATER TANK RECIPIENTE DE AGUA PIED PARASOL

- bestseller
- made of thick plastic with a terminal hole for the mast
- after filled with water, it can weigh up to 20 kg

- bestseller
- hecho de plástico grueso con un orificio terminal para el mástil
- tras llenarse de agua, puede pesar hasta 20 kg

- best-seller
- fabriqué en matière plastique épaisse avec un trou de serrage pour le mât
- une fois remplie d'eau, elle peut peser jusqu'à 20 kg



5907451663189	0,40 kg

WATER TANK WITH ROTATOR

NEW!

- made of thick, flexible plastic
- stainless steel rotator
- after filled with water, it can weigh up to 20 kg

- fabricado en plástico grueso y flexible.
- rotador de acero inoxidable
- una vez lleno de agua, puede pesar hasta 20 kg

- fabriqué en plastique épais et souple
- rotateur en acier inoxydable
- une fois rempli d'eau, il peut peser jusqu'à 20 kg



Pin Ø 16,5 mm

5907451668313	0,40 kg

WATER TANK WITH PIN

NEW!

- made of thick, flexible plastic
- stainless steel pin
- after filled with water, it can weigh up to 20 kg

- fabricado en plástico grueso y flexible.
- pasador de acero inoxidable
- una vez lleno de agua, puede pesar hasta 20 kg

- fabriqué en plastique épais et souple
- goupille en acier inoxydable
- une fois rempli d'eau, il peut peser jusqu'à 20 kg



Pin Ø 16,5 mm

5907451668306	0,40 kg

CARBASE AUTOBASE PIED DE VOITURE

- metal base designed for salons and car stores
- mounted under the car wheel
- optionally a rotator can be used

- base metálica diseñada para salones y tiendas de coches
- montado bajo la rueda del coche
- opcionalmente se puede usar un rotador

- base métallique conçue pour être placée chez les concessionnaires automobiles
- monté sous la roue de la voiture
- un rotateur peut être utilisé en option



Pin Ø 16,5 mm

5907451661925	1,6 kg

BAYONET SINGLE OR DOUBLE BAYONETA INDIVIDUAL O DOBLE PIED PIQUET SIMPLE OU DOBLE

BEST SELLER

- bestseller
- designed for fixing poles to soft grounds
- made of stainless steel
- equipped with a rotator

- bestseller
- diseñado para fijar mástil a suelos blandos
- fabricado en acero inoxidable
- equipado con un rotador

- best-seller
- qui fixent les mâts au sol meuble
- fabriqué en acier inoxydable
- équipé d'un rotateur

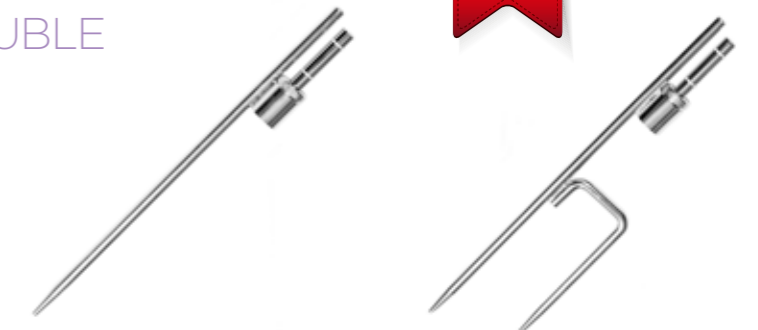

single	5907451661888	0,95 kg
double	5907451661895	1,25kg

Rotator Ø 16,5 mm

DRILL TALADRO PIED FORANT

- perfect for fastening poles to grass and sand
- it has practical, folding handles that help screw the base to the ground
- made of plastic, includes a rotator

- perfecto para sujetar postes a la hierba y la arena
- tiene manijas prácticas y plegables que ayudan a atornillar el base al suelo
- hecho de plástico, incluye un rotador

- le pied forant convient à la fixation de mâts dans le sable et la pelouse
- il est doté de poignées pliables pratiques qui facilitent le vissage de la base au sol
- le pied forant est fabriqué en matière plastique durable



5907451661918	0,7 kg

Rotator Ø 16,5 mm

ROTATORS

ROTATOR 90°

- integrated with a cast iron plate
- ability to attach the base to a hard surface
- set does not include dowels and fastening screws

- integrado con una placa de hierro fundido
- capacidad para fijar la base a una superficie dura
- el juego no incluye varillas ni tornillos de fijación

- intégré dans la plaque en fonte
- la base peut être fixée sur une surface dure
- chevilles et vis de fixation non incluses



5907451661932



0,80 kg

ROTATOR 45°

- used for attaching the poles to the wall
- the set does not include dowels and fastening screws

- usado para sujetar los postes a la pared
- el juego no incluye varillas ni tornillos de fijación

- utilisé pour fixer les mâts au mur
- intégré dans la plaque en fonte
- chevilles et vis de fixation non incluses



5907451661949



0,80 kg

ROTATOR

- made of stainless steel
- a great replacement for standard mandrels used in such bases as: plate, flat cross, auto base
- allows free rotation of the mast in accordance with the direction of the wind

- fabricado en acero inoxidable
- un gran reemplazo de los mandriles estándar usados en estas bases as: placa, cruz plana, base automática permite
- la libre rotación del mástil según la dirección del viento

- en acier inoxydable
- remplace avantageusement les goupilles standard dans les bases telles que les plaques, les barres transversales plates, les bases auto
- permet au mât de tourner librement dans la direction du vent



5907451661840



0,45 kg



TENT FRAMES



TIENDAS
CADRE DE TENTE



- tent racks made of two types of materials: steel or aluminium
 - several sizes available
 - Everest - lightweight design, ideal for frequent change of location
 - Blanc - heavy, durable construction, powder coated white
- The set includes: foldable tent frame, mounting accessories, trolley bag.

- portapuestas para tiendas de campaña fabricadas con dos tipos de materiales: acero o aluminio
 - varias tallas disponibles
 - Everest - diseño ligero, ideal para cambios frecuentes de ubicación
 - Blanc - construcción pesada y duradera, blanco recubierto en polvo
- El set incluye: armazón plegable de tienda de campaña, accesorios de montaje, bolsa con ruedas.

- cadres de tentes fabriquées en deux types de matériaux: acier ou aluminium
 - disponibles en plusieurs tailles
 - Everest - construction plus légère, idéale pour les déplacements fréquents.
 - Blanc - construction lourde et durable, peinte en blanc
- Le kit comprend: un cadre de tente pliable, accessoires de montage, un sac de transport.

		
BLANC (steel) 2,5x2,5	5907451661697	23 kg
BLANC (steel) 3x3	5907451661703	25 kg
BLANC (steel) 3x4,5	5907451661710	32 kg
BLANC (steel) 3x6	5907451661727	44 kg
EVEREST (aluminium) 3x3	5907451661734	17 kg
EVEREST (aluminium) 3x4,5	5907451661741	21 kg
EVEREST (aluminium) 3x6	5907451661758	32 kg

Print assembly modules:

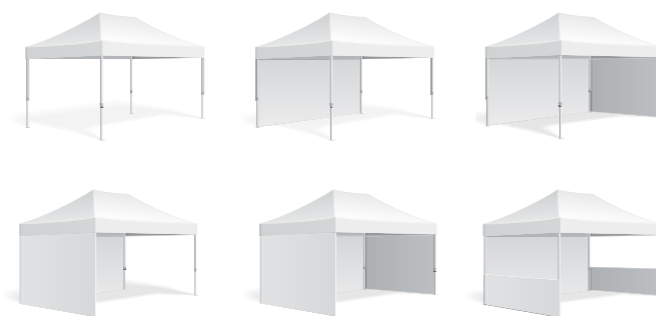

Recommended media and printing technology for this system:

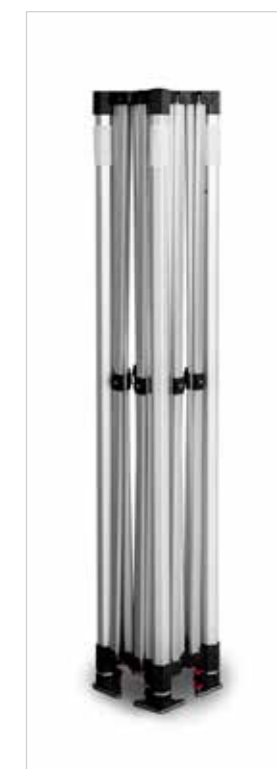
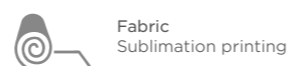

TENT CANOPY

TECHOS PARA ARMAZÓN DE CARPA
TOIT POUR CADRE DE TENTE

- | | | |
|---|--|--|
| <ul style="list-style-type: none"> ■ waterproof ■ durable colours (resistant to UV radiation) ■ resistant to tearing (polyester 250-270 g) | <ul style="list-style-type: none"> ■ impermeabilidad ■ mayor resistencia al desgarro ■ fácil de limpiar (poliéster 250-270 g) | <ul style="list-style-type: none"> ■ imperméable à l'eau ■ résistance accrue à la déchirure (en polyester 250-270 g) ■ facile à nettoyer ■ couleurs durables (résistantes aux rayons UV) |
|---|--|--|



	Barcode	Weight
3x3 white	5907451666272	3,9 kg
3x3 blue	5907451666289	3,9 kg
3x3 black	5907451666302	3,9 kg
3x3 red	5907451666296	3,9 kg
3x4,5 white	5907451666760	5 kg
3x4,5 blue	5907451666746	5 kg
3x4,5 black	5907451666777	5 kg
3x4,5 red	5907451666753	5 kg
3x6 white	5907451666715	8 kg
3x6 blue	5907451666739	8 kg
3x6 black	5907451666708	8 kg
3x6 red	5907451666722	8 kg

ACCESSORIES

HORSESHOE (of cast iron)



Barcode	Weight
5907451661963	5 kg

WATER TANK FOR TENT LEGS (of plastic)



Barcode	Weight
5907451669990	1 kg + 14 l

SANDBAG SINGLE



Barcode	Weight
5907451663332	0,1 kg + 12 kg

SANDBAG DOUBLE



Barcode	Weight
5907451661987	0,3 kg + 18 kg

FLAG BASE



Barcode	Weight
5907451661956	1 kg

HALFBAR (of aluminium)



Length	Barcode	Weight
3 m	5907451661994	1,2 kg
4,5 m	5907451662007	1,6 kg



TABLES

- solid construction (polyethylene + steel)
- perfect for outdoor event
- non-slips pads on legs
- foldable
- special handle ensures easy transport (122, 180x75)

- construcción sólida (polietileno + acero) - perfecto para eventos al aire libre
- protectores antideslizantes en las patas
- plegable
- un mango especial facilita la facilidad transporte (122, 180x75)

- construction robuste (polyéthylène + acier)
- idéal pour les événements en plein air
- embouts antidérapants
- pliable
- poignée spéciale pour faciliter le transport (122, 180x75)

COCKTAIL TABLE 80



5907451664957 | 8 kg

EVENT TABLE 180x75

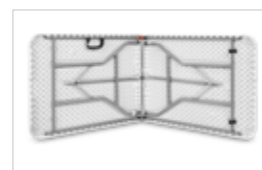
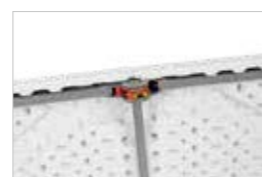

5907451664988 | 12 kg

EVENT TABLE ROUND 122

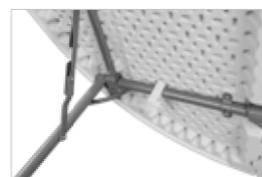

5907451664964 | 11 kg

TABLE HEADER

- simple assembly
- great, original advertising area
- header mounted to rectangular tables
- ensamblaje simple
- gran área publicitaria original
- cabecera montada en mesas rectangulares
- grande surface publicitaire originale
- montage de la tête de lit sur des tables rectangulaires
- l'image est installée sur la construction du topper de la même manière qu'on „enfile une chaussette”



5907451664971 | 1,5 kg

TABLECLOTH

- flexible tablecloth
- made of polyester and elastine
- washable, no need to be ironed
- mantel flexible
- fabricado en poliéster y elastina
- lavable, no hace falta planchado
- elle ne se plisse pas
- elle est lavable et ne nécessite pas de repassage
- élastique

TABLECLOTH 80



white 5907451664926 | 0,5 kg
black 5907451665220 | 0,5 kg

TABLECLOTH 122



white 5907451664933 | 0,5 kg
black 5907451665213 | 0,5 kg

TABLECLOTH 180



white 5907451664940 | 0,5 kg
black 5907451665206 | 0,5 kg

WE MEET
EXPECTATIONS

PRO
-MEDIA-
PLUS

Szubinska 32, 60-114 Poznan, Poland

+48 61 307 60 62

www.promediaplus.pl



This catalog with your company's logo.

*Download from www.promediaplus.pl, put your logo
and data on, print out and use as a great sales tool.*