

2025

KATALOG PRODUKTÓW

SYSTEMY REKLAMOWE DLA DRUKARNI
I AGENCJI REKLAMOWYCH

PRO
-MEDIA-
PLUS

WYCHODZIMY
NAPRZECIW
OCZEKIWANIOM



O NAS / ABOUT US

 Jesteśmy jednym z największych producentów i dystrybutorów systemów reklamowych w Europie. W naszej ofercie znajdziesz m.in. roll upy, maszty flagowe, produkty drewniane, potykacze, stelaże namiotów i wiele więcej.

 We are one of the largest manufacturer and distributor of advertising media and display systems in Europe. Our offer includes a.o.: roll-ups, ad. walls, flag poles, wooden products, tent frames and much more.



GWARANTUJEMY / WE GUARANTEE:



INDYWIDUALNE
WARUNKI



DOSTĘP DO OFERTY
ONLINE 24/7





SZYBKĄ DOSTAWĘ
DO KRAJÓW UE

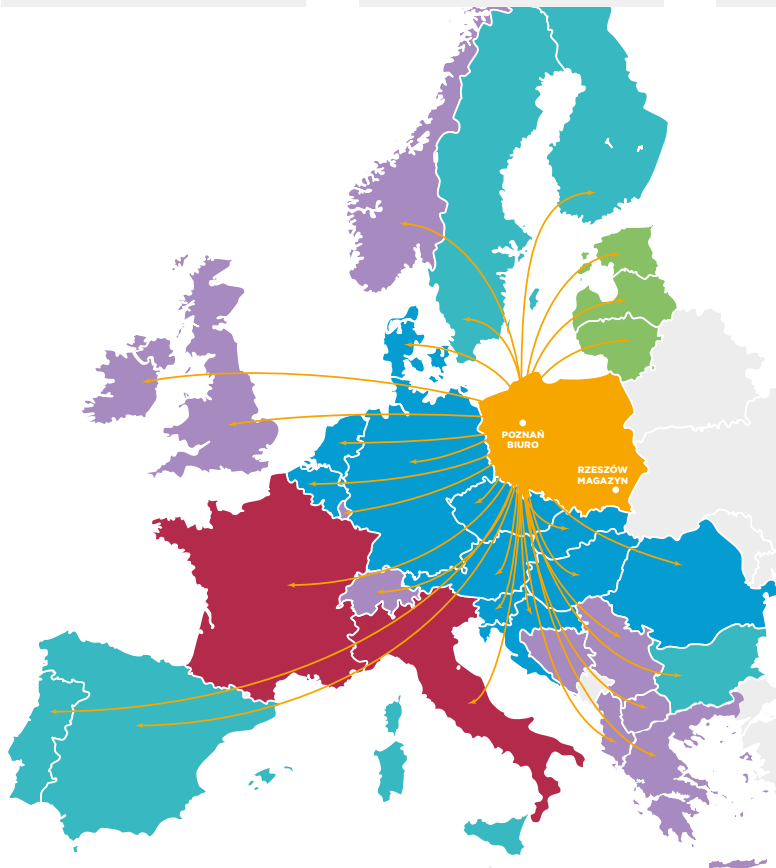

WSPARCIE TECHNICZNE
WYNIKAJĄCE Z 20 LAT
DOŚWIADCZENIA



	 Palety	 Paczki		
Obszar 1	24 h	GEIS	24 h	FEDEX
Obszar 2	48 h	GEIS	3 dni	UPS
Obszar 3	2-4 dni	RABEN	2-3 dni	UPS
Obszar 4	3-5 dni	RABEN	3 dni	UPS
Obszar 5	4-7 dni	RABEN	4-5 dni	UPS
Obszar 6	termin ustalany indywidualnie			

Podane powyżej terminy dostaw dotyczą dni roboczych. Terminy mogą się zmienić w zależności m.in. od warunków atmosferycznych.

DOŁĄCZ DO NAS / JOIN US:
WWW.PROMEDIAPLUS.COM

SPIS TREŚCI

INDOOR

LED It's time to shine!	5
System LUMIX™	6
LED BOX™	8
LED BOX™ Srebrny	8
LED BOX™ Czarny	9
LED BOX™ Flex	10
LED BOX™ Plus	12
LED BOX™ Wall Frame	13
Trybunka LUMIX™	14
Trybunka LED BOX™	15
Trybunki Preston Automatic LED	16
Preston Automatic LED Oval	16
Preston Automatic LED Prostokąt	16

ROLL UP	17
Compact	18
Standard	20
Standard Plus	22
Classic	24
Basic	26
Premium	28
Pro	30
Exclusive	32
Exclusive Black	34
Wave	36
Twin	38
Standard Black	40
Akcesoria do rollupów	42

STANDY	43
X-Banner Compact	44
X-Banner Standard	44
L-Banner Premium	45
L-Banner Premium Twin	45
Atlantis Expo	46

ŚCIANKI REKLAMOWE	47
System Mega Seg™	48
Pop-Up Prosta	50
Pop-Up Łukowa	51
Standard Magnetic Pop-Up Prosta	52
Standard Magnetic Pop-Up Łukowa	53
Premium Magnetic Pop-Up Prosta	54
Premium Magnetic Pop-Up Łukowa	55
Black Pro Magnetic Pop-Up Prosta	56

Black Pro Magnetic Pop-Up Łukowa	57
Velcro Pop-Up Prosta	58
Velcro Pop-Up Łukowa	59
Atlantis Prosta	60
Atlantis Łukowa	61
Atlantis S	62
Atlantis U	63
Ścianka konferencyjna	63
Combi 1	64
Combi 2	64
Versum	65
Versum XL	65
Akcesoria do ścianek	66

STOISKA TARGOWE	67
LUMIX™	68
Akcesoria do stoisk targowych LUMIX™	70
Uchwyt na monitor	70
Locker Set	70
System półek	70

TRYBUNKI I STOJAKI NA ULOTKI	71
Trybunki Promo	72
Promo 0	72
Promo 1	72
Promo 2	73
Promo 3	73
Promo 4	73
Trybunki Preston	74
Preston Oval	74
Preston Trójkąt	74
Preston „Nerka”	75
Preston Prostokąt	75
Preston XXL	75
Velcro Pop-Up	76
Pop-Up 2x1	76
Pop-Up 2x2	76
Promo 2 Plus	77
Topper	77
Trybunki Preston Automatic	78
Preston Automatic Oval	78
Preston Automatic LED Oval	78
Preston Automatic Prostokąt	78
Preston Automatic LED Prostokąt	78
Trybunka LUMIX™	79

Trybunka LED BOX™	79
Stojaki na ulotki	80
Montana Srebrna	80
Montana Czarna	81
Boston	82
Atlanta	82
Columbia	83
Lincoln	83
Trybunka Dallas	84
Trybunka Concord	84
Virginia	84

RAMKI I LISTWY PLAKATOWE	85
Listwy plakatywne	86
Standard	87
Slim	87
Clip	87
Twin	87
Ramki OWZ podwieszane Vertico	88
Ramki OWZ Standard	89
Ramki OWZ Srebrne	89
Ramki OWZ Czarne	89
Ramki OWZ Premium	90
Ramki Magnetic	91
Magnetic	91
Magnetic Rewers	91
Magnetic BHP	91
Tabliczki przydrzwiowe	92
Sonic	92
Gert	92
Elite	93
Puro	93
Manta	93
Stojaki akrylowe	94
Crystal	94
Platinum	94
Vista	95
Systemy linkowe	96
System ściana-ściana	96
System ściana-podłoga/sufit	96
System sufit-podłoga	97
System sufit-tablica	97
Akcesoria	98
Dystanse	98

OUTDOOR

POTYKACZE	99
Aurora	100
Spider	101
Hampton	102
Hampton Pro	103
Info Stand Chroma	104
Info/Menu Stand Puladi	105
Info/Menu Stand Classic	106
Info/Menu Stand Standard	106
Info/Menu Stand Premium	107
Ształuga metalowa	108

PRODUKTY DREWNIANE	109
Potykaniec Classic	110
Classic	110
Classic Naturalny	110
Potykaniec PRO Wodoodporny	111
Markery kredowe	111
Tablice kredowe	112
Stojaki kredowe	112
Ształugi	113
Leżaki	114

SŁUPKI ODGRADZAJĄCE	116
Słupki Premium	116
Główce wymienne do słupków	116
Słupki hotelowe	117
Royal Chrom	117
Modern Chrom	117
Royal Złoty	117
Modern Złoty	117
Border Welurowy	117
Border Pleciony	117
Ramki informacyjne na słupki	118
Głowica naścienna	118

MASZTY FLAGOWE	119
Maszty Standard	120
Maszt PRO	121
Twister Standard	122
Twister Shark Fin	122
Maszt H	123
Avenue	123
Podstawy do flag	124
Rotatory	128

STELAŻE DO NAMIENTÓW	129
Stelaże do namiotów	130
Dachy do namiotów	132
Akcesoria	132

MEBLE EVENTOWE	133
Stoły	134
Stół koktajlowy 80	134
Stół 180x75	134
Stół okrągły 122	134
Topper do stołu 180x75	135
Obrusy	135
Obrus do stołu 80	135
Obrus do stołu 122	135
Obrus do stołu 180	135
Krzeseła	136
Krzesełko składane	136
Krzesełko koktajlowe	136
Pokrowce na krzesło koktajlowe	136

Podane w katalogu wymiary i wagi produktów mają charakter orientacyjny. Mogą się nieznacznie różnić w zależności od partii dostawy.
The product dimensions and weights shown in the catalogue are indicative. They may vary slightly depending on the delivery batch.

WYBRANE NOWOŚCI

HAMPTON PRO

Potykaniec wyjątkowo odporny na warunki atmosferyczne. Dzięki szerokiej ramie aluminiowej (40 mm) osadzonej na sprężynach, produkt dostosowuje się do siły wiatru. Podstawa po wypełnieniu wodą sprawia, że Hampton PRO staje się bardzo stabilnym i ciężkim systemem reklamowym.

Więcej - strona 103



ZWIĘKSZONA
ODPORNOŚĆ
NA WARUNKI
ATMOSFERYCZNE



STABILNY
PODCZAS
WIATRU



SZYBKA
WYMIANA
GRAFIKI
(RAMKA OWZ)



OSŁONA
NA PLAKAT
Z FILTEM UV



SYSTEM
DWUSTRONNY

LED BOX™ FLEX

Dwustronny, podświetlany system, który rozłożysz jednym ruchem. **LED BOX™ FLEX wyróżnia konstrukcja oparta na zawiasach, którą wystarczy rozłożyć.** Mechanizm ten gwarantuje błyskawiczne rozłożenie całego produktu.

Zintegrowane oświetlenie LED zasilane za pomocą szybkozłączek (kable zasilające ukryte w profilach aluminiowych) to kolejna zaleta oferowanego systemu.

Więcej - strony 10-11

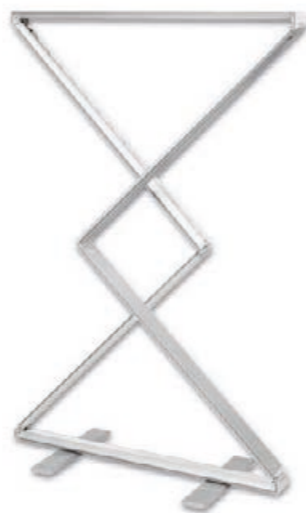

KONSTRUKCJA
OPARTA NA
ZAWIASACH



SZYBKOZŁĄCZKI
ZASILAJĄCE
OŚWIETLENIE
LED



MONTAŻ BEZ
NARZĘDZI



SYSTEM
DWUSTRONNY



WYDRUK
NA TKANINIE
(MONTAŻ NA TAŚMIE
SILIKONOWEJ)

STOISKA TARGOWE LUMIX™

Podświetlane i montowane bez użycia narzędzi - to tylko niektóre z zalet stoisk targowych LUMIX. Kilkadziesiąt żarówek LED gwarantuje spektakularny efekt wydruku. **Wysoką jakość, łatwy montaż oraz długi czas użytkownia produktu gwarantuje m.in. szeroki profil aluminiowy (12 cm) i wydruk na tkaninie montowany na taśmie silikonowej.**

Więcej - strony 68-69



SZEROKI
PROFIL
ALUMINIOWY



MONTAŻ BEZ
NARZĘDZI



SYSTEM
DWUSTRONNY



WYDRUK
NA TKANINIE
(MONTAŻ NA TAŚMIE
SILIKONOWEJ)



It's time to shine!

LED

SYSTEM LUMIX™

PREMIUM LINE



- dwustronny, podświetlany system
 - szeroki profil aluminiowy (12 cm)
 - montaż bez użycia narzędzi
 - wydruk montowany przy użyciu taśmy silikonowej
 - torba na kółkach
- Zestaw zawiera: system LUMIX, zasilacz, torbę transportową.

- double-sided, eye-catching LED system
 - wide aluminium profile (12 cm)
 - no tools assembly
 - silicon tape mounted printout
 - sturdy wheeled transport bag
- The set includes: LUMIX system, power adapter, transport bag.



Produkty LUMIX możesz rozbudowywać, tworząc dzięki temu systemy o bardzo różnych wielkościach. Możesz je również łączyć ze sobą w unikalne zabudowy targowe. **SPRAWDŹ NASZE GOTOWE ZABUDOWY TARGOWE - STRONY 68-69**



STWÓRZ MULTIMEDIALNE I JESZCZE BARDZIEJ FUNKCJONALNE STOISKO, DZIĘKI DOSTĘPNYM AKCESORIOM.



Za pomocą zestawu Long Set możesz podwyższyć system LUMIX o 50 cm - do 300 cm.

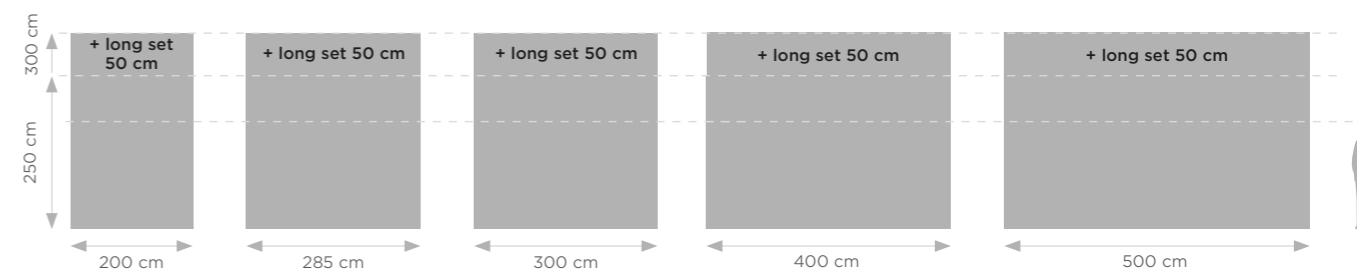

Za pomocą zestawu XL Set możesz rozbudować system LUMIX o 85 lub 100 cm.

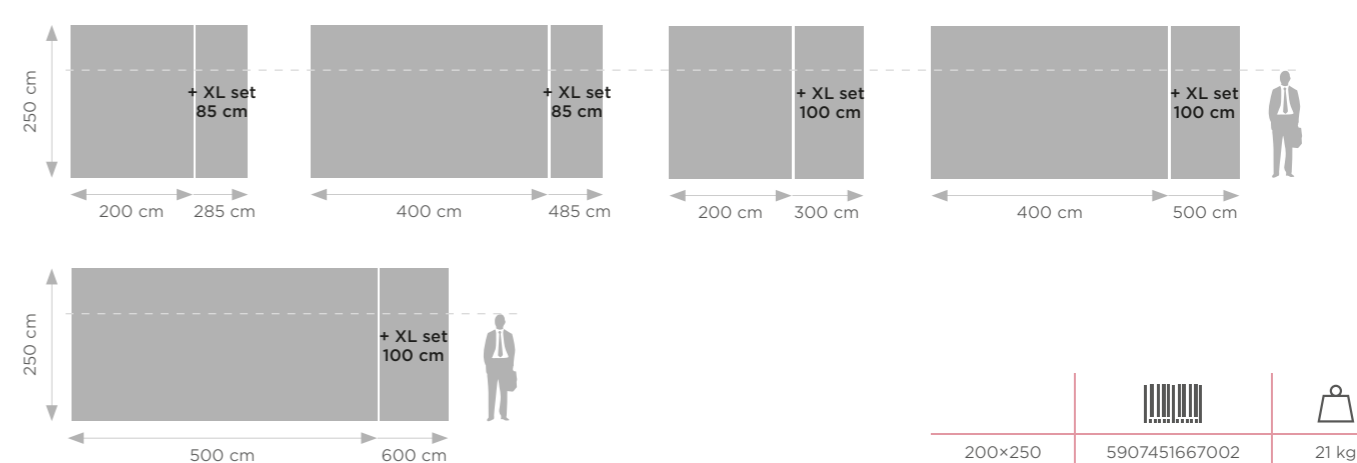

Rekomendowana technologia druku:



Tkanina
Druk sublimacyjny

200x250	5907451667002	21 kg
285x250	5907451667187	26 kg
300x250	5907451667019	27 kg
400x250	5907451667026	29 kg
500x250	5907451667033	36 kg

LED BOX™

- dwustronny, podświetlany system
- profil aluminiowy (8 cm)
- konstrukcja bazująca na szybkołączkach zasilających zintegrowane oświetlenie LED

Zestaw zawiera: LED BOX, konektory szeregowe, zasilacz, taśmę silikonową, walizkę z kartonu.

- double-sided LED system
- durable aluminium frame (8 cm)
- design based on quick-connects for powering the integrated LED lighting

The set includes: LED BOX, parallel connectors, power adapter, silicon tape, cardboard case.



LED BOX™ SREBRNY

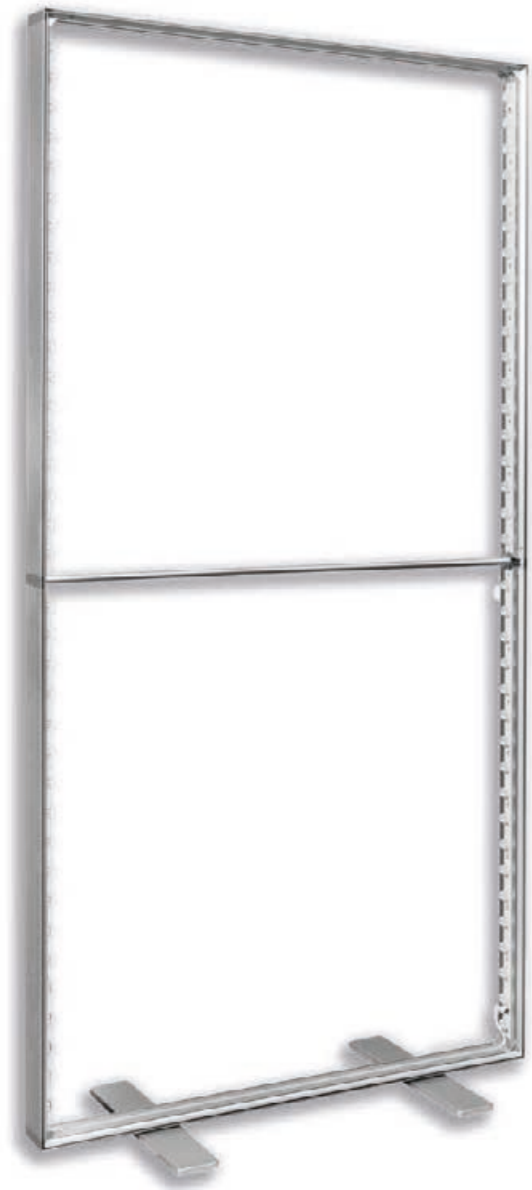

LED BOX™ CZARNY

NEW!



PRODUKTY LED BOX MOŻESZ ŁĄCZYĆ ZE SOBĄ ZA POMOCĄ DOSTĘPNYCH KONEKTORÓW (SZEREGOWO LUB PROSTOPADLE).



100x200 (srebrny)	5907451664001	9,2 kg
100x230 (srebrny)	5907451669921	10 kg
100x250 (srebrny)	5907451669914	12 kg
100x200 (czarny)	5907451667507	9,2 kg
100x230 (czarny)	5907451667514	10 kg
100x250 (czarny)	5907451667521	12 kg

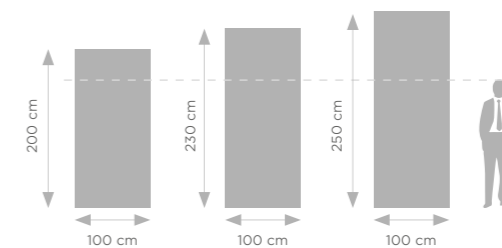

Rekomendowana technologia druku:

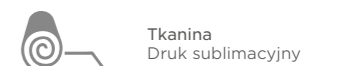

LED BOX™ FLEX

NEW!

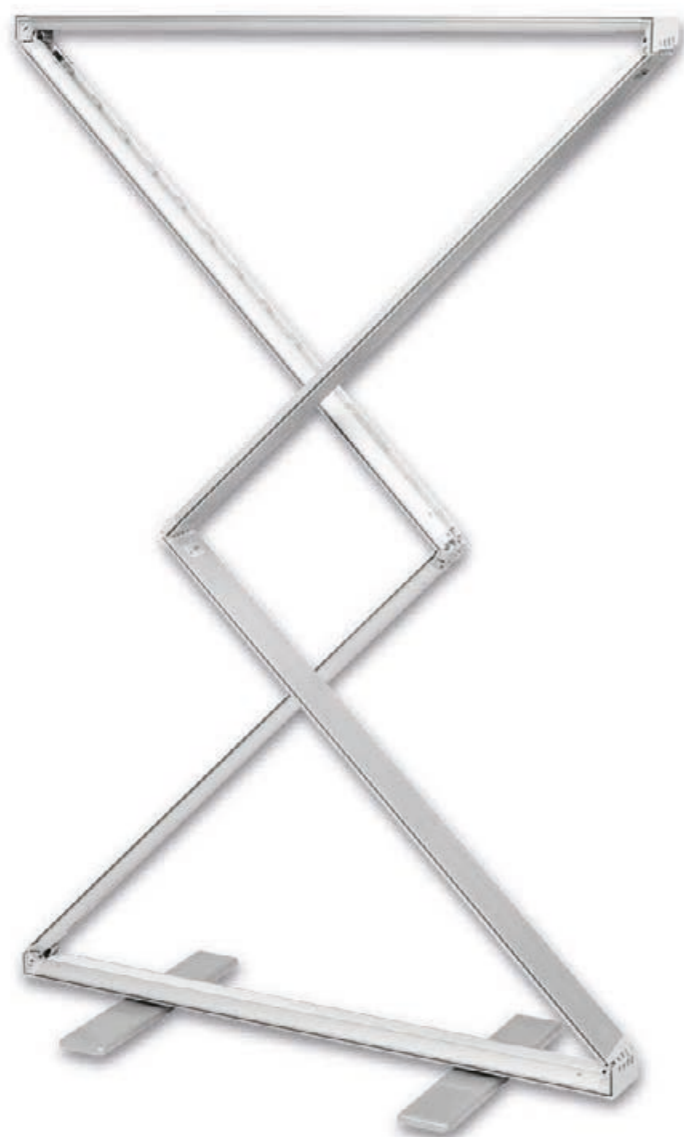

8,5 cm
PROFIL
ALUMINIOWY



KONSTRUKCJA
OPARTA NA
ZAWIASACH



SZYBKOZŁĄCZKI
ZASILAJĄCE
OŚWIETLENIE LED



WYDRUK
NA TKANINIE
(MONTAŻ NA TAŚMIE
SILIKONOWEJ)



MONTAŻ BEZ
NARZĘDZI



DWUSTRONNY
SYSTEM

- konstrukcja oparta na zawiasach = błyskawiczne rozłożenie produktu
 - profil aluminiowy (8,5 cm)
 - konstrukcja bazująca na szybkozłączkach zasilających oświetlenie LED
 - wydruk na tkaninie montowany na taśmie silikonowej
 - montaż bez użycia narzędzi
 - opcja łączenia produktów
- Zestaw zawiera: LED BOX FLEX, zasilacz, torbę transportową, indywidualny karton.

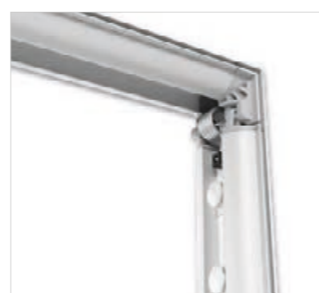

- hinge-based construction = express unfolding
 - durable aluminium frame (8,5 cm)
 - Integrated LED lighting powered by quick-connectors (power cables hidden in the aluminium profiles)
 - option to combine products
 - silicon tape mounted printout
 - no tools assembly
- The set includes: LED BOX FLEX, power adapter, transport bag.

LED BOX FLEX WYROŻNIA KONSTRUKCJA OPARTA NA ZAWIASACH, KTÓRĄ WYSTARCZY ROZŁOŻYĆ.

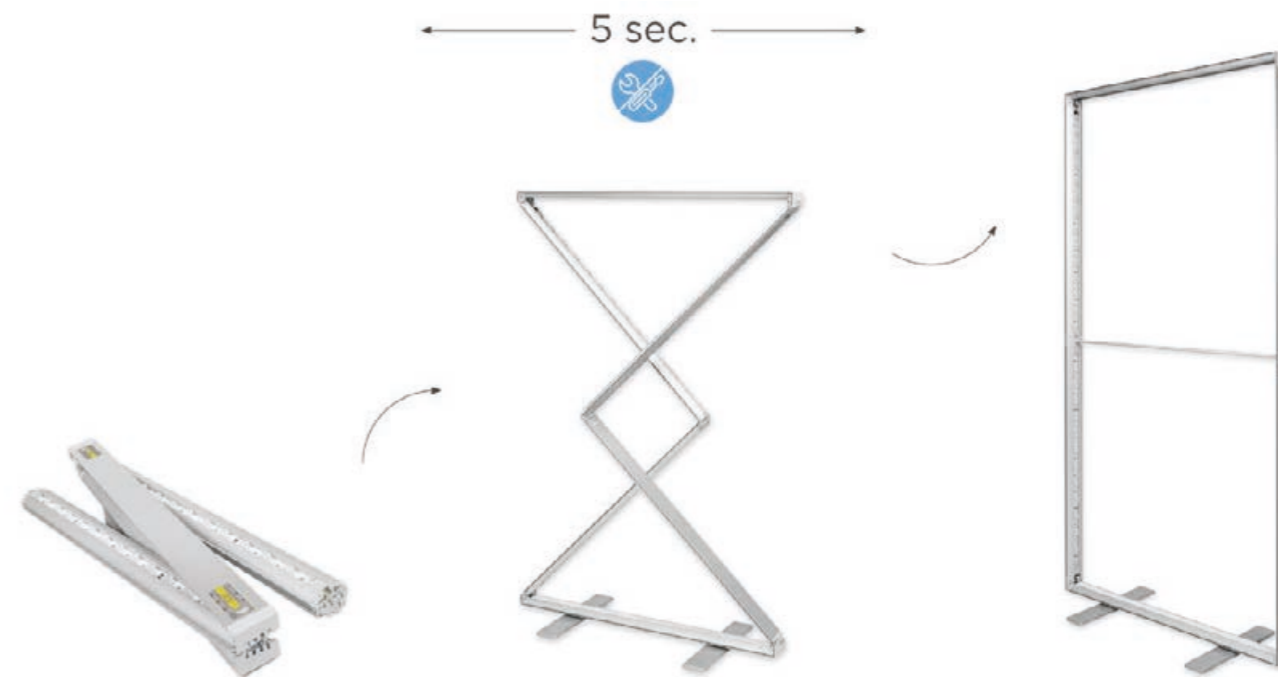

PRODUKTY LED BOX FLEX MOŻESZ ŁĄCZYĆ SZEREGOWO ZA POMOCĄ WMONTOWANYCH W RAMĘ MAGNESÓW.

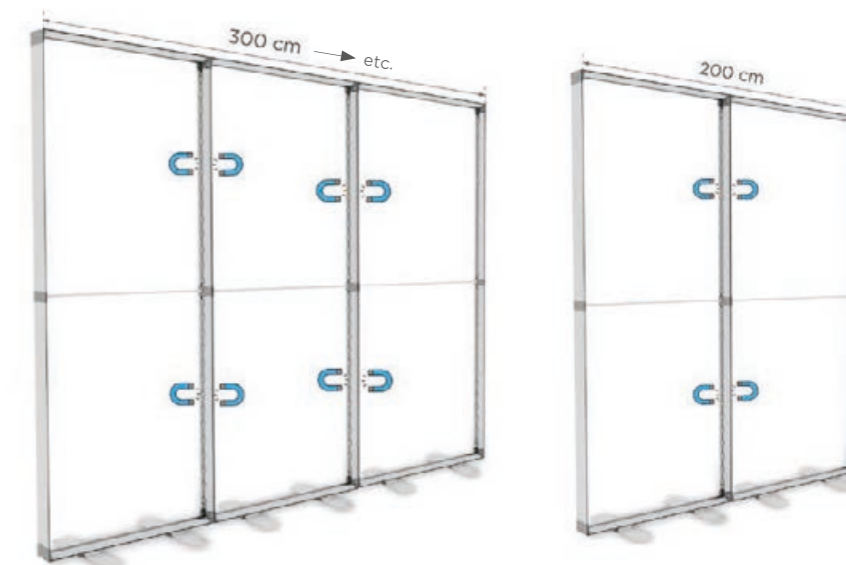

100x200	5907451667415	7 kg
---------	---------------	------

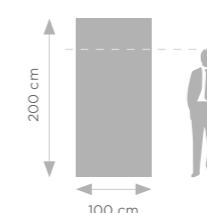

Rekomendowana technologia druku:

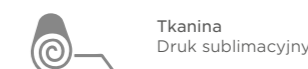

LED BOX™ PLUS



- LED
- 10 cm
SZEROKI PROFIL ALUMINIOWY
- SZYBKOZŁĄCZKI ZASILAJĄCE OŚWIETLENIE LED
- WYDRUK NA TKANINIE (MONTAŻ NA TAŚMIE SILIKONOWEJ)
- MONTAŻ BEZ NARZĘDZI
- DWUSTRONNY SYSTEM

200x200	5907451668870	15 kg
300x200	5907451668856	22 kg
200x230	5907451668863	16 kg
300x230	5907451668849	23 kg

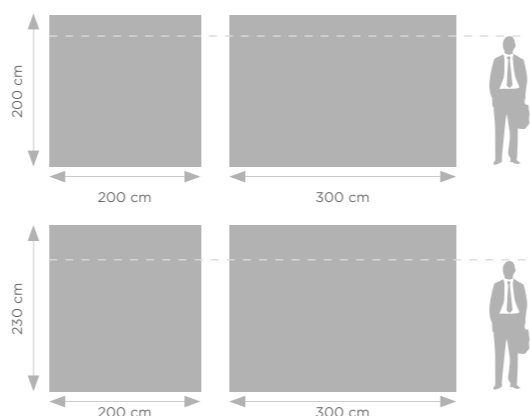

Rekomendowana technologia druku: Tkanina Druk sublimacyjny

LED BOX™ WALL FRAME NEW!

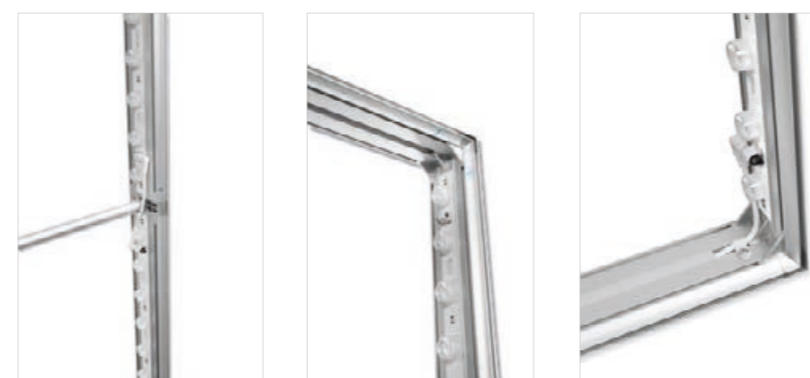
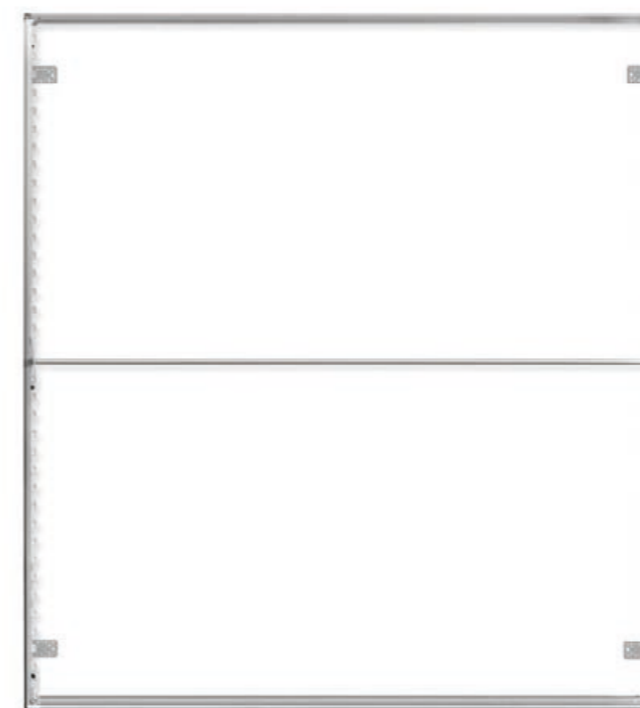

- LED
- 8 cm
PROFIL ALUMINIOWY
- WYDRUK NA TKANINIE (MONTAŻ NA TAŚMIE SILIKONOWEJ)
- MONTAŻ BEZ NARZĘDZI

- dwustronny, podwieszany system z lampkami LED
 - solidna aluminiowa rama (8 cm)
 - złożenie produktu bez użycia narzędzi
 - grafika montowana za pomocą taśmy silikonowej
- Zestaw zawiera: LED BOX WALL FRAME, akcesoria do mocowania, przewód zasilający.

- double-sided, suspended LED system
 - durable aluminium frame (8 cm)
 - no tools assembly
 - silicon tape mounted printout
- The set includes: LED BOX WALL FRAME, mounting accessories, power cable.



Rekomendowana technologia druku: Tkanina Druk sublimacyjny

TRYBUNKA LUMIX™

NEW!

PREMIUM LINE



- LED
- 12 cm
SZEROKI PROFIL ALUMINIOWY
- WYDRUK NA TKANINIE (MONTAŻ NA TAŚMIE SILIKONOWEJ)
- MONTAŻ BEZ NARZĘDZI
- DWUSTRONNY SYSTEM
- TORBA NA KÓŁKACH

TRYBUNKA LED BOX™



- LED
- 8 cm
PROFIL ALUMINIOWY
- WYDRUK NA TKANINIE (MONTAŻ NA TAŚMIE SILIKONOWEJ)
- MONTAŻ BEZ NARZĘDZI
- DWUSTRONNY SYSTEM

- dwustronny system
 - szeroki profil aluminiowy (12 cm)
 - zintegrowane oświetlenie LED
 - montaż bez narzędzi
 - wydruk na tkaninie montowany na taśmie silikonowej
 - torba na kółkach
- Zestaw zawiera: trybunkę LUMIX, zasilacz, torbę transportową na kółkach.

- double-sided system
 - wide aluminium profile (12 cm)
 - integrated LED lighting
 - no tools assembly
 - silicon tape mounted printout
 - wheeled transport bag
- The set includes: LUMIX counter, power adapter, wheeled transport bag.

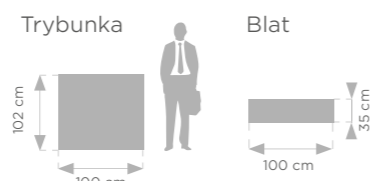

Rekomendowana technologia druku:



5907451667422 10 kg

- dwustronny, podświetlany system
 - profil aluminiowy (8 cm)
 - montaż bez narzędzi
 - wydruk na tkaninie montowany na taśmie silikonowej
- Zestaw zawiera: trybunkę LED BOX, zasilacz, torbę transportową

- double-sided LED system
 - durable aluminium frame (8 cm)
 - no tools assembly
 - silicon tape mounted printout
- The set includes: LED BOX counter, power adapter, transport bag.

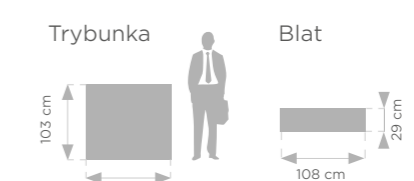

Rekomendowana technologia druku:



5907451669815 7 kg

TRYBUNKI PRESTON AUTOMATIC LED

- automatyczna trybunka LED
- montaż bez narzędzi
- wydruk na tkaninie montowanej na taśmie silikonowej

Zestaw zawiera: trybunkę PRESTON, torbę transportową.

- automatic, no tools assembly
- LED system
- silicone tape mounted printout

The set includes: PRESTON counter, transport bag.

Rekomendowana technologia druku:

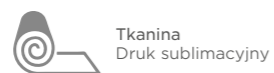

PRESTON AUTOMATIC LED OWAL

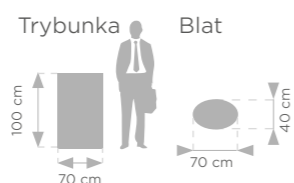
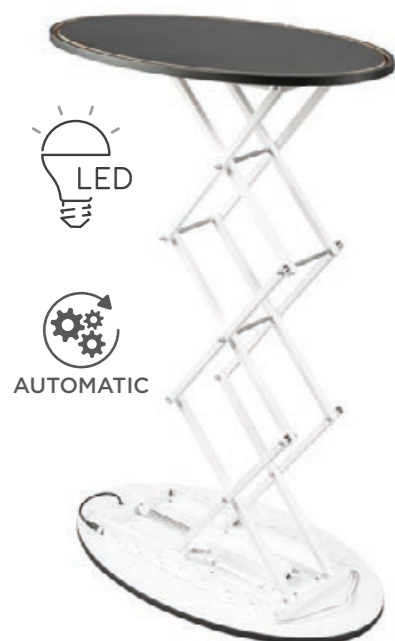

PRESTON AUTOMATIC LED PROSTOKĄT

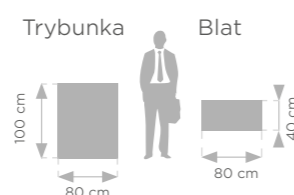
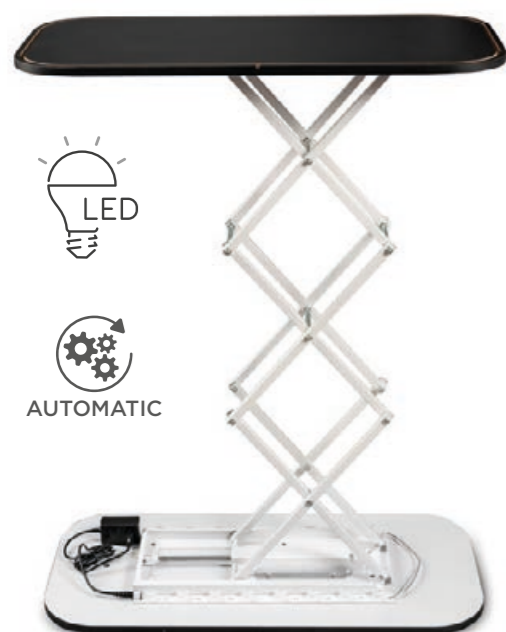

ROLL UP

COMPACT

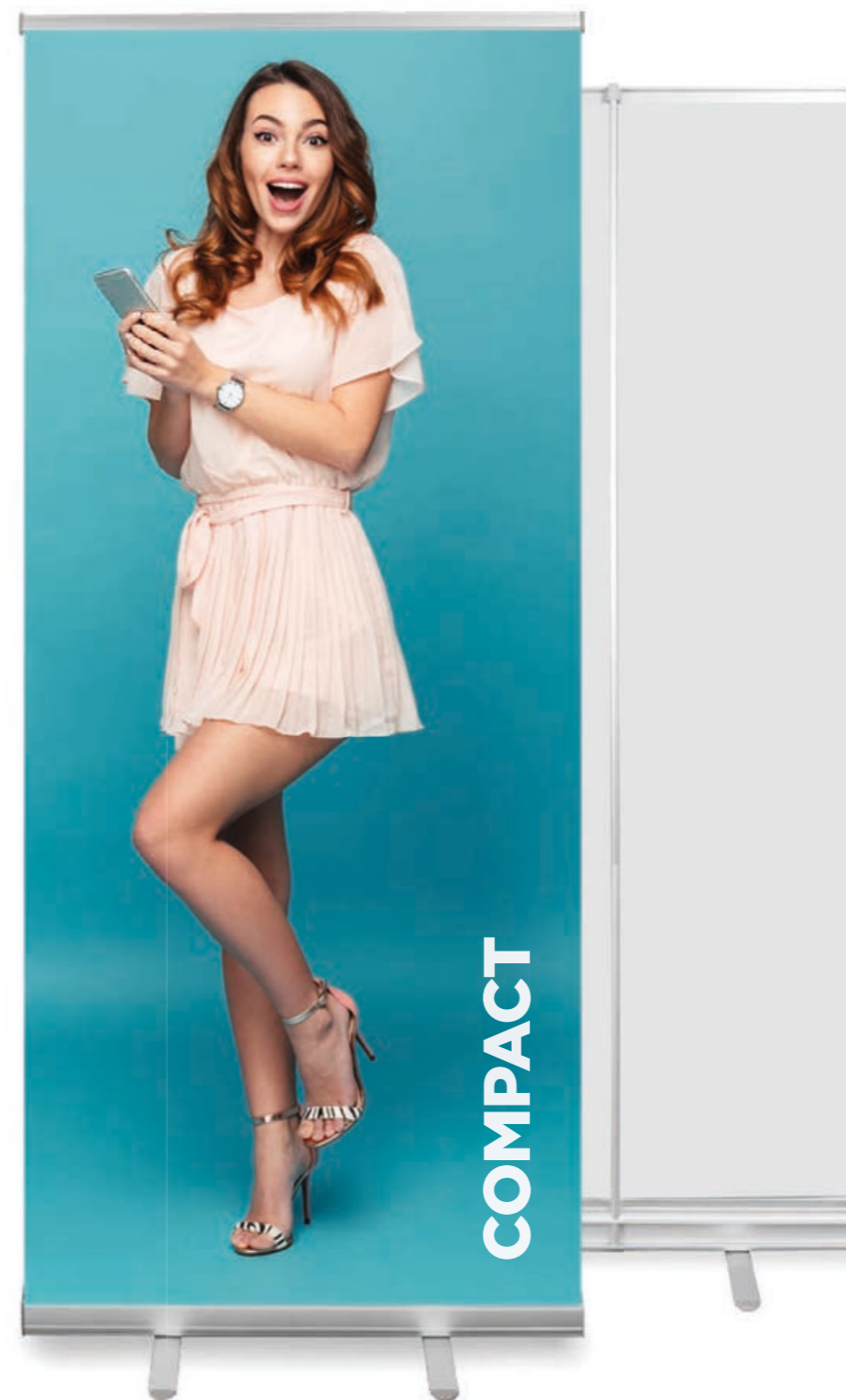

- lider cenowy!
- mały, poręczny i łatwy w transporcie
- średnica kasety zredukowana z 9,3 do 8,3 cm
- listwa „Express Clip” – błyskawiczny i łatwy montaż wydruku
- produkt ekonomiczny, ceniony przy dużych kampaniach

Zestaw zawiera: kasety typu Compact, maszt, listwę zatrzaskową „Express Clip” z taśmą 3M, torbę transportową z okienkiem na wizytówkę.

- price leader!
- small, compact and easy to carry
- cassette dimension reduced from 9,3 to 8,3 cm
- “Express Clip” top bar – quick and easy print assembly
- economy class product, valued for big adv campaigns

This set includes: Compact roll up cassette, pole, “Express Clip” top bar with 3M adhesive tape, bag with business card pocket.

80×200	5907451662762	1,5 kg
85×200	5907451660010	1,56 kg
100×200	5907451660027	1,73 kg

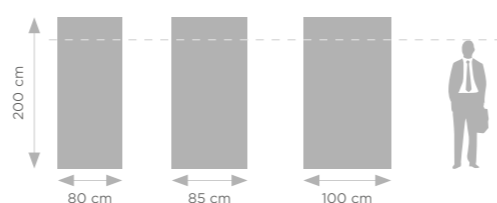

Rekomendowana technologia druku:



STANDARD



TORBA
LONG ZIP

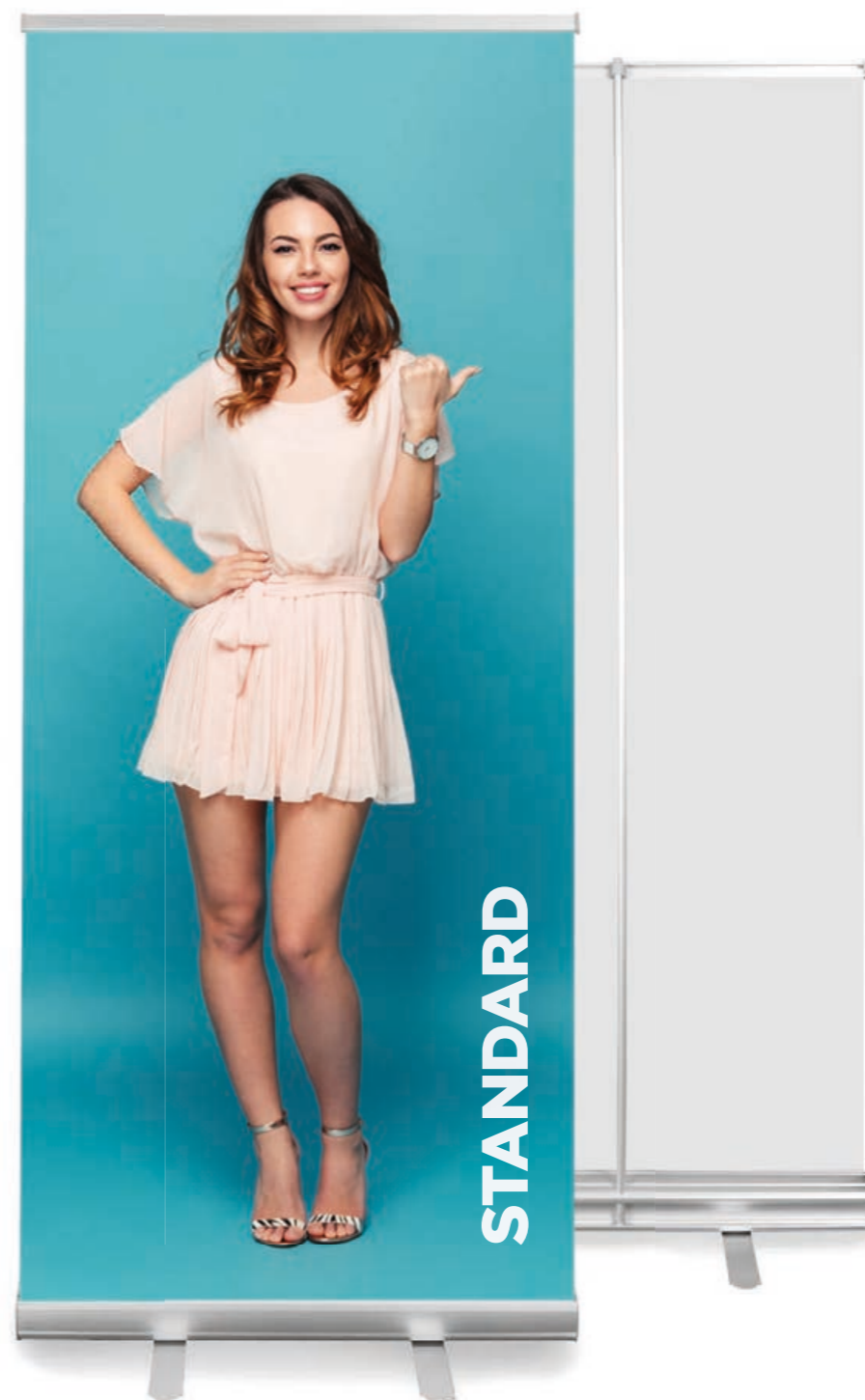

- bestseller na wielu rynkach
- mocna konstrukcja w 100% z anodowanego aluminium
- listwa „Express Clip” – błyskawiczny i łatwy montaż wydruku
- wzmocniona ścianka tylna ze stabilizatorem masztu
- torba z długim zipem

Zestaw zawiera: kasetę typu Standard, maszt (rozmiary 120×200 i 150×200 posiadają dwa maszty), listwę zatrzaskową „Express clip”, taśmę 3M, torbę transportową z okienkiem na wizytówkę, indywidualny karton.

- bestseller on many markets
- stable, strong construction, 100% made of anodized aluminum
- “Express clip” top bar – quick and easy print assembly
- reinforced rear panel with the pole stabilizer
- transport bag with a long zipper

This set includes: Standard roll up cassette, pole (sizes 120×200 and 150×200 include 2 poles), “Express clip” top bar, 3M adhesive tape, bag with a business card pocket, individual box.

85×200	5907451660034	1,64 kg
100×200	5907451660041	2 kg
120×200	5907451660058	2,4 kg
150×200	5907451660065	3,05 kg

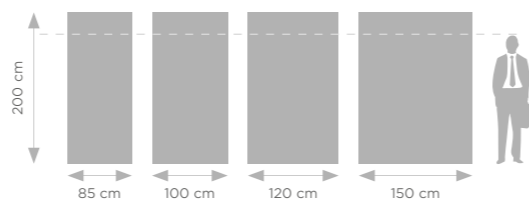

Rekomendowana technologia druku:



Stoplight
Solvent, UV, Latex



Baner powlekany
Solvent, UV, Latex



STANDARD PLUS



TORBA
LONG ZIP

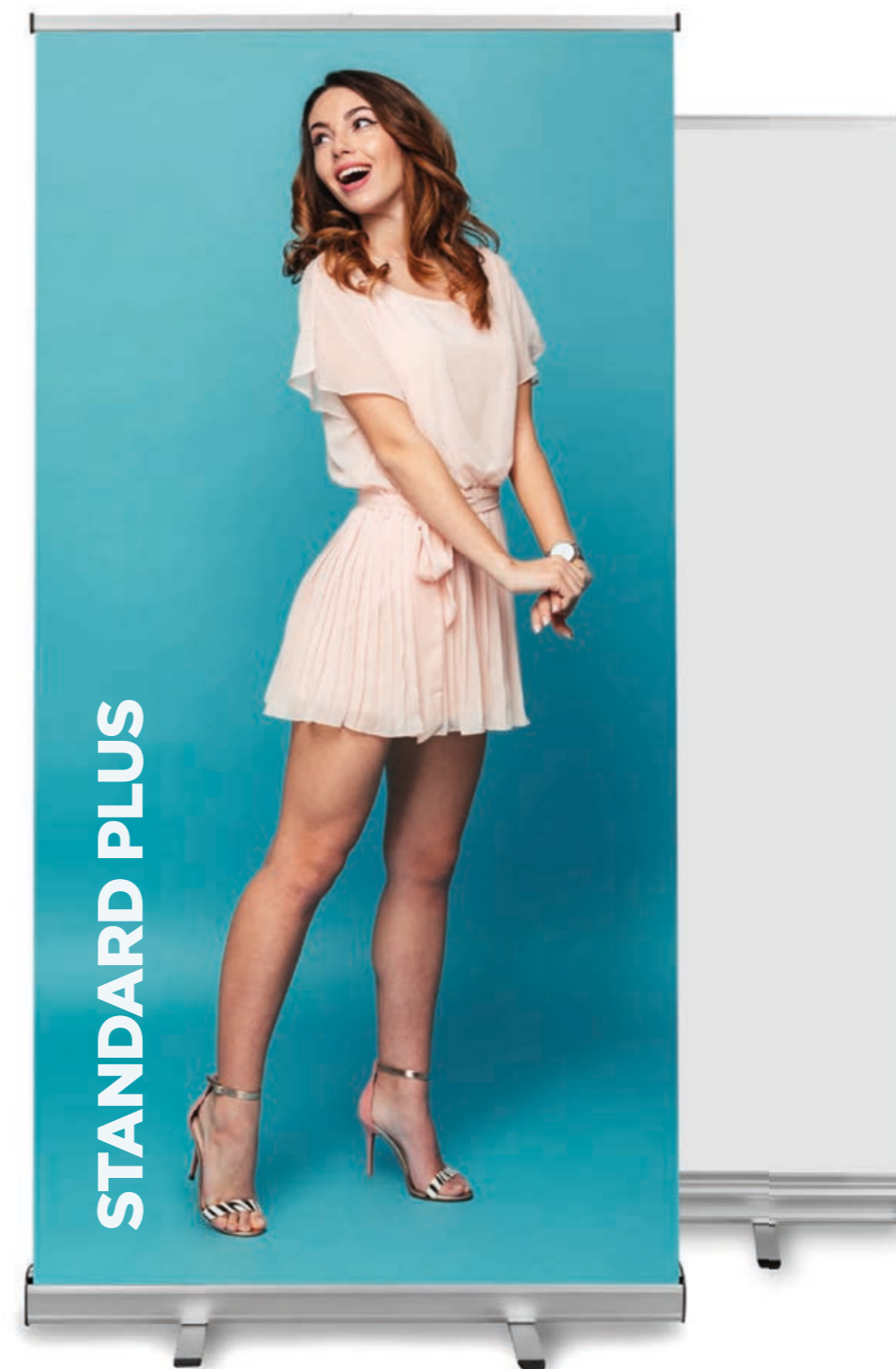

- boki kasety z tworzywa sztucznego, bardziej wytrzymałe na wgniecenia
- wzmocniona ścianka tylna ze stabilizatorem masztu
- listwa „Express Clip” – błyskawiczny i łatwy montaż wydruku
- torba z długim zapięciem

Zestaw zawiera: kasetę typu Standard Plus, maszt (rozmiary 120×200 i 150×200 posiadają dwa maszty), listwę zatrzaskową „Express clip”, taśmę 3M, torbę transportową z okienkiem na wizytówkę, indywidualny karton.

- plastic sides of the cassette, more resistant to dents
- reinforced rear panel with the pole stabilizer
- “Express Clip” top bar – quick and easy print assembly
- transport bag with a long zipper

This set includes: Standard Plus roll up cassette, pole (sizes 120×200 and 150×200 include 2 poles), “Express clip” top bar, 3M adhesive tape, bag with a business card pocket, individual box.

85×200	5907451662427	1,6 kg
100×200	5907451662434	2 kg
120×200	5907451662724	2,4 kg
150×200	5907451662731	3,05 kg

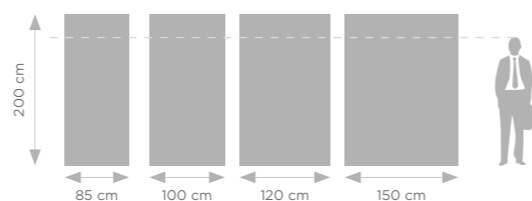

Rekomendowana technologia druku:



Stoplight
Solvent, UV, Latex



Baner powlekany
Solvent, UV, Latex



CLASSIC



TORBA
LONG ZIP

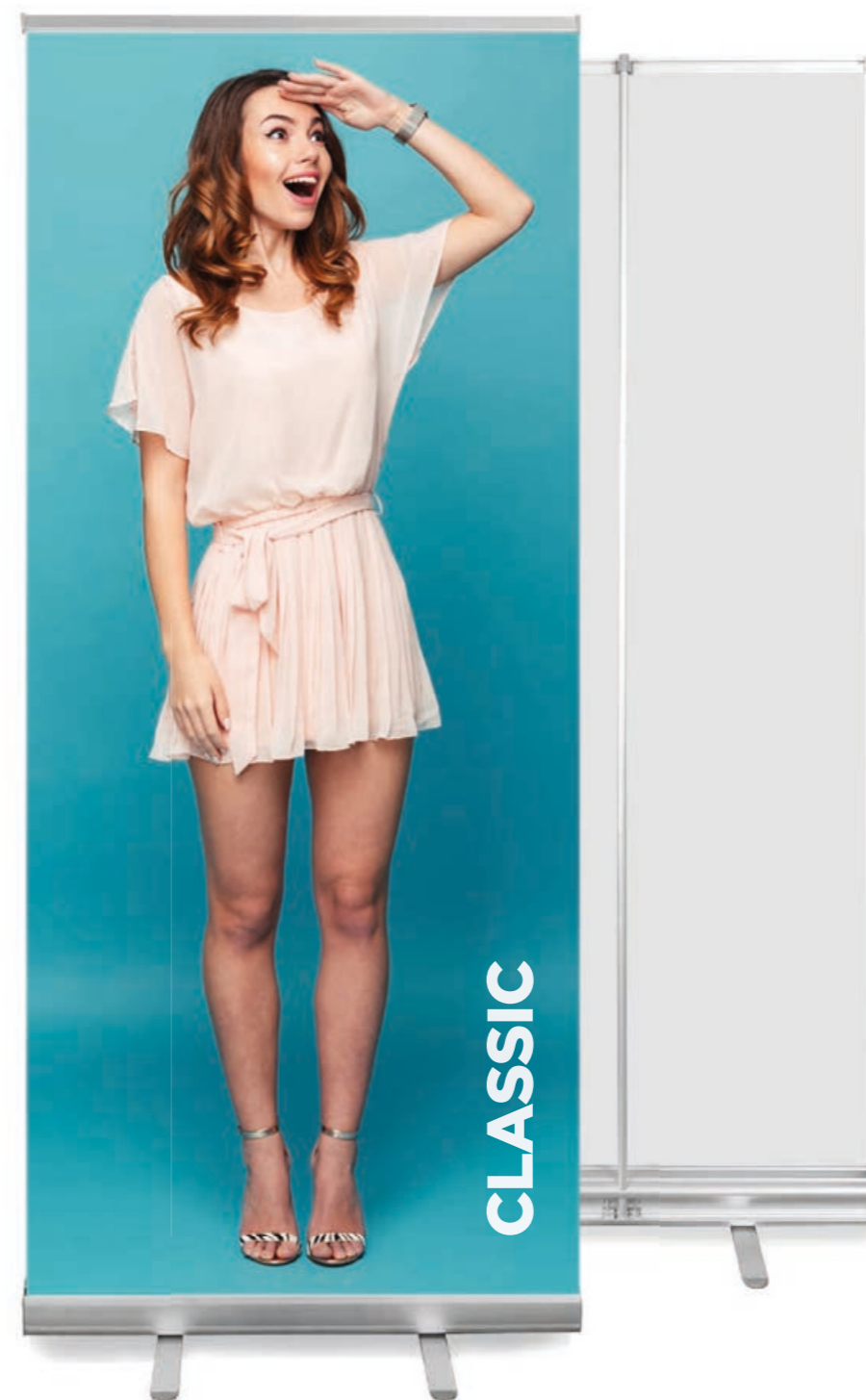

- bestseller na wielu rynkach
- wzmocniona tylna ścianka ze stabilizatorem masztu
- listwa „Express Clip” – błyskawiczny i łatwy montaż wydruku
- plastikowe końcówki nóżek
- torba z długim zipem

Zestaw zawiera: kasetę typu Classic, maszt (rozmiary 120×200 i 150×200 posiadają dwa maszty), listwę zatrzaskową „Express clip”, taśmę 3M, torbę transportową z okienkiem na wizytówkę, indywidualny karton.

- bestseller on many markets
- reinforced rear panel with the pole stabilizer
- “Express Clip” top bar – quick and easy print assembly
- plastic foot tips
- transport bag with a long zipper

This set includes: Classic roll up cassette, pole (sizes 120×200 and 150×200 include 2 poles), “Express Clip” top bar, 3M adhesive tape, bag with a business card pocket, individual box.

80×200	5907451660638	1,68 kg
85×200	5907451660072	1,8 kg
100×200	5907451660089	1,9 kg
120×200	5907451660096	2,6 kg
150×200	5907451660102	3,4 kg

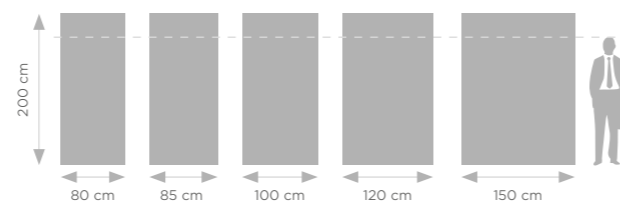

Rekomendowana technologia druku:



BASIC



TORBA
LONG ZIP

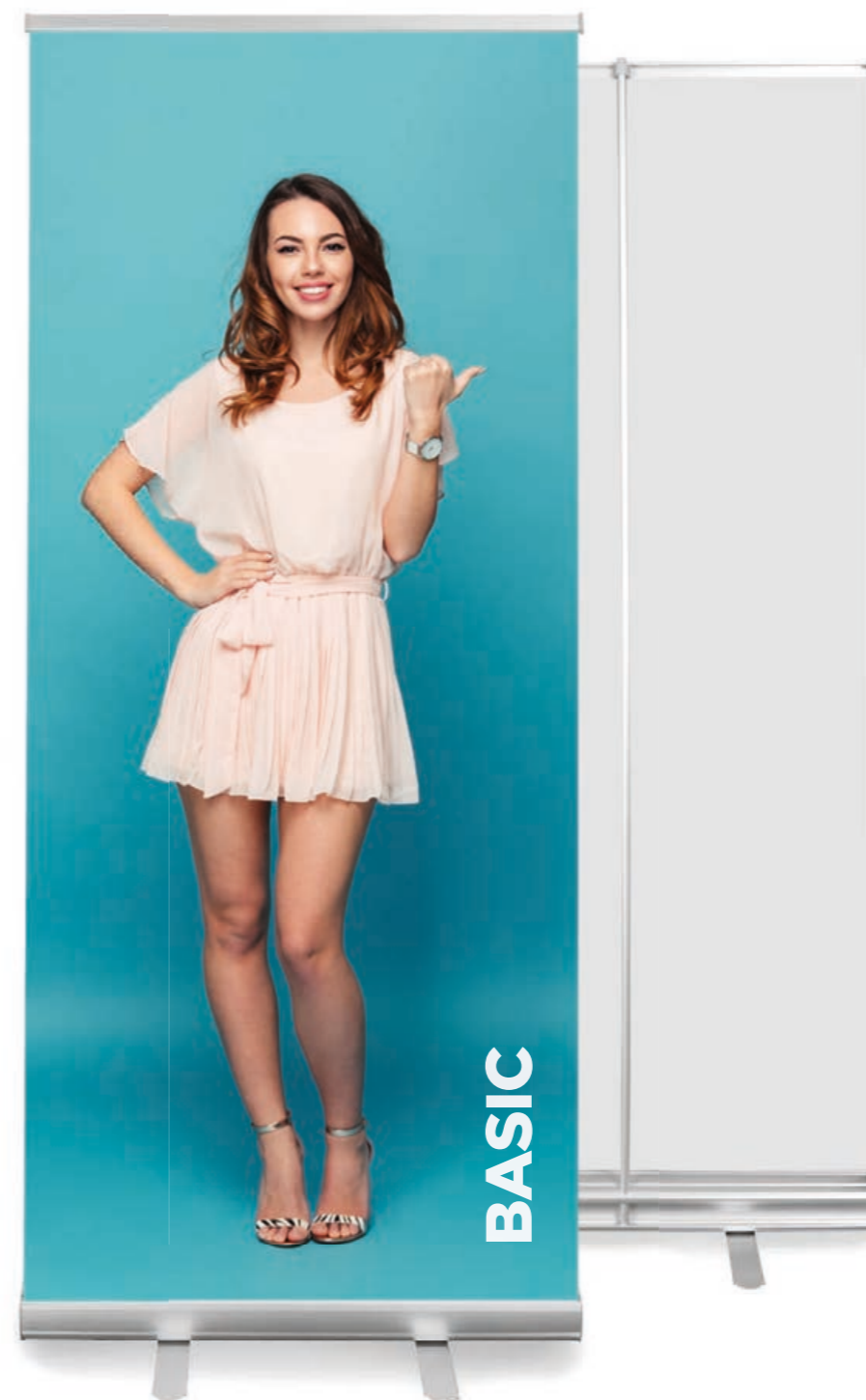

- solidna, aluminiowa konstrukcja
- stabilizator masztu
- listwa „Express Clip” – błyskawiczny i łatwy montaż wydruku
- wyściełana, gustowna torba z zapięciem long zip

Zestaw zawiera: kasetę typu Basic, maszt (rozmiary 120×200 i 150×200 posiadają dwa maszty), listwę zatrzaskową „Express Clip”, taśmę 3M, torbę transportową z okienkiem na wizytówkę, indywidualny karton.

- stable, strong construction, 100% made of anodized aluminum
- the pole stabilizer
- “Express Clip” top bar – quick and easy print assembly
- padded transport bag with a long zipper and trimming

This set includes: Basic roll up cassette, pole (sizes 120×200 and 150×200 include 2 poles), “Express Clip” top bar, 3M adhesive tape, bag with a business card pocket, individual carton box.

80×200	5907451668191	1,9 kg
85×200	5907451668061	2,1 kg
100×200	5907451668078	2,5 kg
120×200	5907451668085	3 kg
150×200	5907451668092	3,7 kg

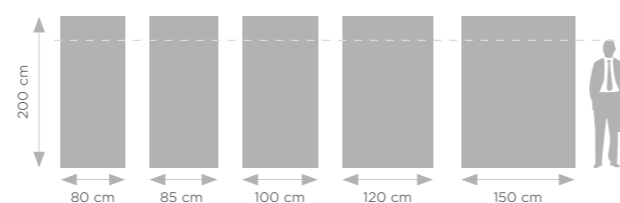

Rekomendowana technologia druku:



Stoplight
Solvent, UV, Latex



Baner powlekany
Solvent, UV, Latex



PREMIUM



TORBA
LONG ZIP

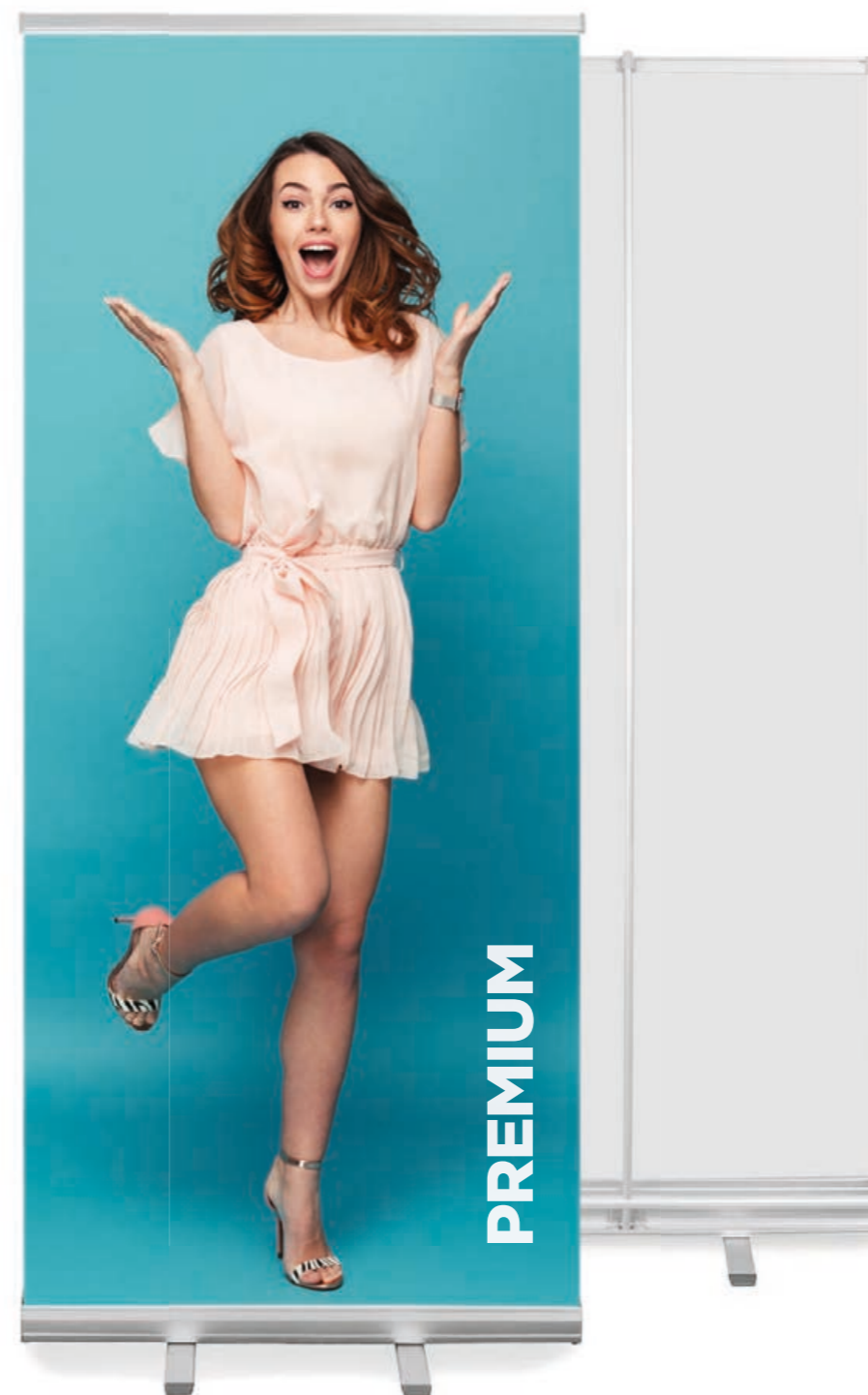

- solidna, ciężka konstrukcja
- wzmocniona tylna ścianka ze stabilizatorem masztu
- błyskawiczny montaż grafiki i ulepszony system zwijający
- zakończenia nóg i boki w eleganckim ciemnym kolorze
- wyściełana, gustowna torba z zapięciem long zip

Zestaw zawiera: kasetę typu Premium, maszt (rozmiary 120×200 i 150×200 posiadają dwa maszty), listwę zatrzaskową „Express Clip”, taśmę 3M, torbę transportową z okienkiem na wizytówkę, indywidualny karton.

- solid, heavy construction
- reinforced rear panel with the pole stabilizer
- “Express Clip” top bar – quick and easy print assembly
- foot tips and side walls in dark elegant colour
- padded transport bag with a long zipper and trimming

This set includes: Premium roll up cassette, pole (sizes 120×200 and 150×200 include 2 poles), „Express Clip” top bar, 3M adhesive tape, bag with a business card pocket, individual carton box.

80×200	5907451668009	2 kg
85×200	5907451660119	2,2 kg
100×200	5907451660126	2,7 kg
120×200	5907451660133	3,5 kg
150×200	5907451660140	4 kg

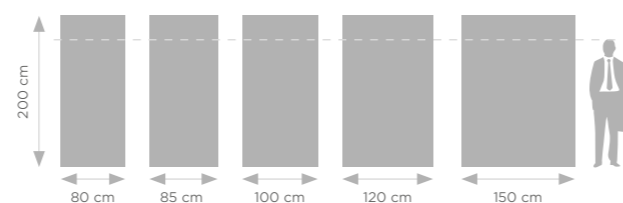

Rekomendowana technologia druku:



Stoplight
Solvent, UV, Latex



Baner powlekany
Solvent, UV, Latex



PRO

PREMIUM LINE



TORBA
LONG ZIP



- dostępny również w rozmiarze 200×200 cm
- najgrubszy profil aluminiowy spośród standardowych kaset
- ciężka, bardzo solidna kaseca
- listwa „Express Clip” – błyskawiczny i łatwy montaż wydruku
- wyściełana torba z długim zipem

Zestaw zawiera: kasetę typu Pro, maszt (rozmiary 120×200 i 150×200 posiadają dwa maszty, rozmiar 200×200 posiada trzy maszty), listwę zatrzaskową „Express clip”, taśmę 3M, torbę transportową z okienkiem na wizytówkę, indywidualny karton.

- 200×200 cm size available
- the thickest aluminium profile among standard cassettes
- heavy and very stable product
- “Express Clip” top bar – quick and easy print assembly
- padded transport bag with a long zipper and trimming

This set includes: Pro roll up cassette, pole (sizes 120×200 and 150×200 include 2 poles, size 200×200 includes 3 poles), “Express Clip” top bar, 3M adhesive tape, bag with a business card pocket, individual box.

85×200	5907451660584	2,7 kg
100×200	5907451660591	3,1 kg
120×200	5907451660607	3,7 kg
150×200	5907451660614	4,7 kg
200×200	5907451660621	6,2 kg

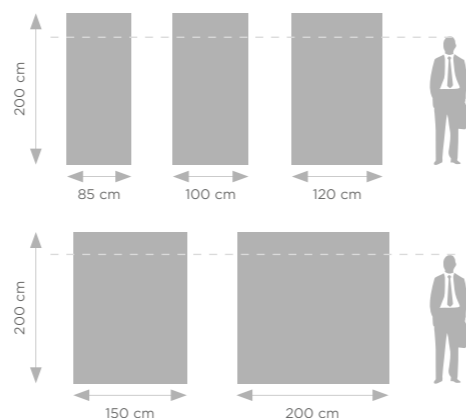

Rekomendowana technologia druku:



Stoplight
Solvent, UV, Latex



Baner powlekany
Solvent, UV, Latex

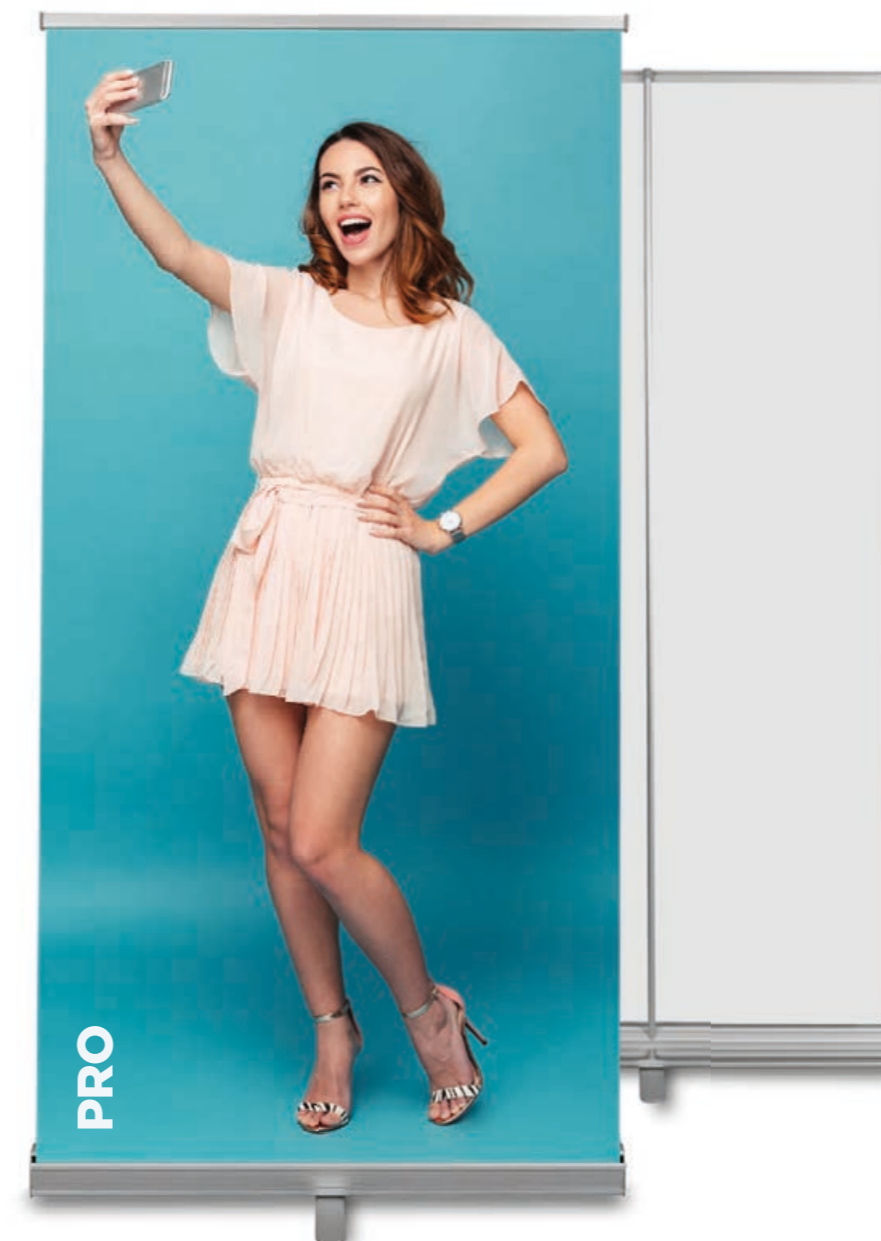

200 cm

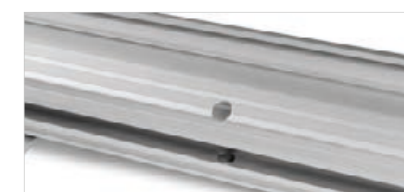

EXCLUSIVE

PREMIUM LINE

BEST SELLER

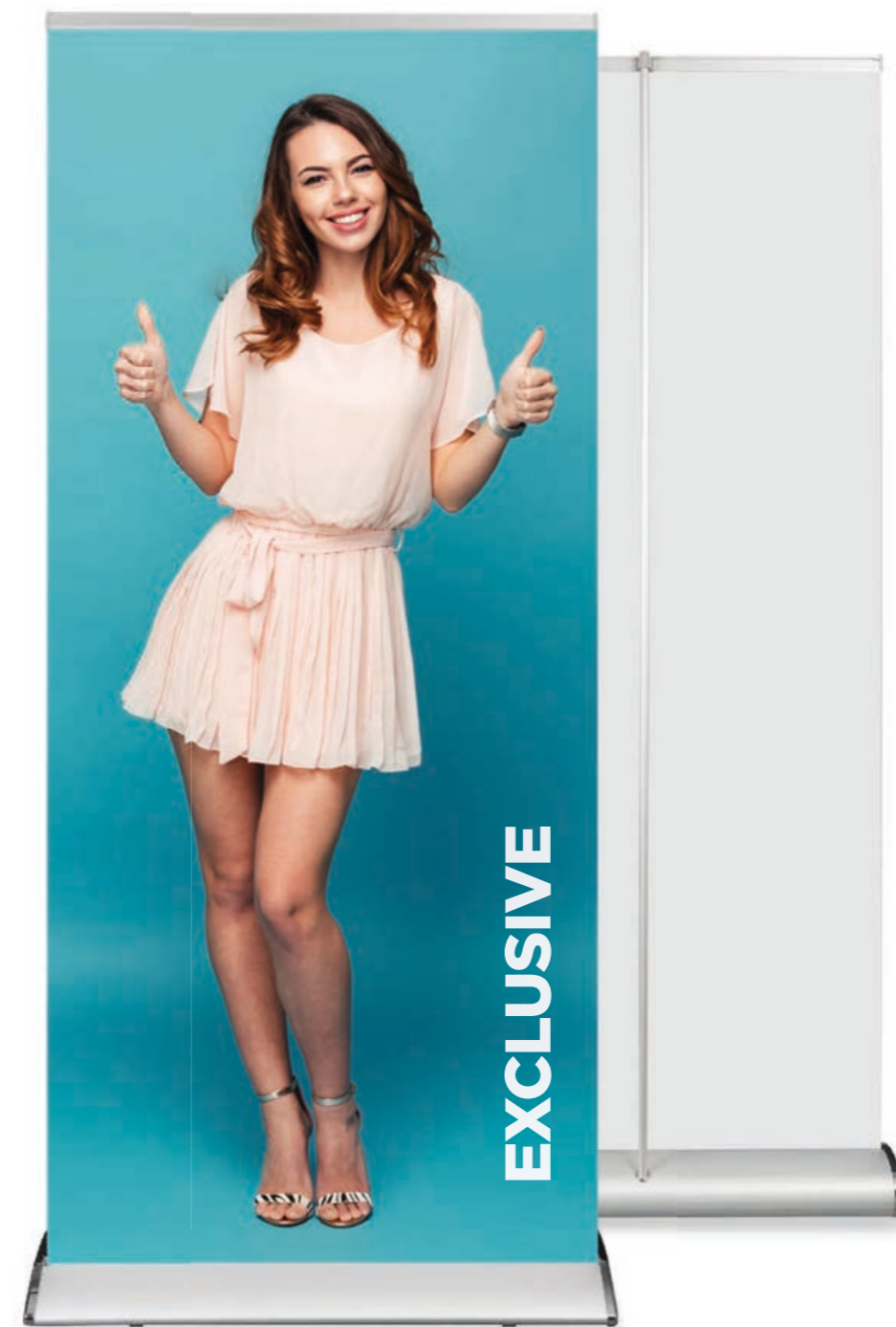

- wyjątkowo elegancki wygląd
- dostępny również w rozmiarze 200×200 cm
- bardzo ciężka, stabilna kasetka
- listwa „Express Clip” – błyskawiczny i łatwy montaż wydruku
- elegancka torba z długim zapięciem

Zestaw zawiera: kasetę typu Exclusive, maszt (rozmiary 120×200 i 150×200 posiadają dwa maszty, rozmiar 200×200 posiada trzy maszty), listwę zatrzaskową „Express clip”, taśmę 3M, torbę transportową z okienkiem na wizytówkę, indywidualny karton.

- elegant appearance
- 200×200 cm size available
- heavy and very stable product
- “Express Clip” top bar – quick and easy print assembly
- elegant carrying bag with a long zipper

This set includes: Exclusive roll up cassette, pole (sizes 120×200 and 150×200 include 2 poles, size 200×200 includes 3 poles), “Express Clip” top bar, 3M adhesive tape, bag with a business card pocket, individual box.

85×200	5907451660492	2,7 kg
100×200	5907451660508	3,2 kg
120×200	5907451660515	3,8 kg
150×200	5907451660522	4,8 kg
200×200	5907451660539	6,4 kg

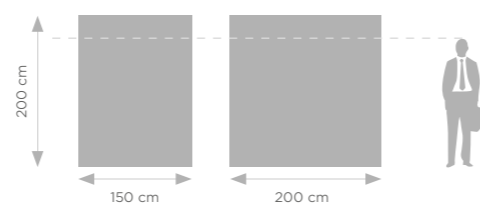
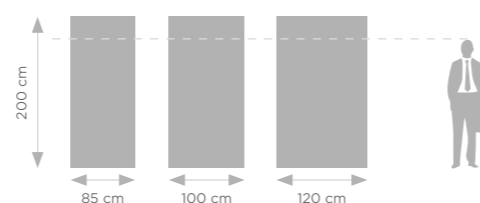

Rekomendowana technologia druku:



EXCLUSIVE BLACK

NEW!

PREMIUM LINE

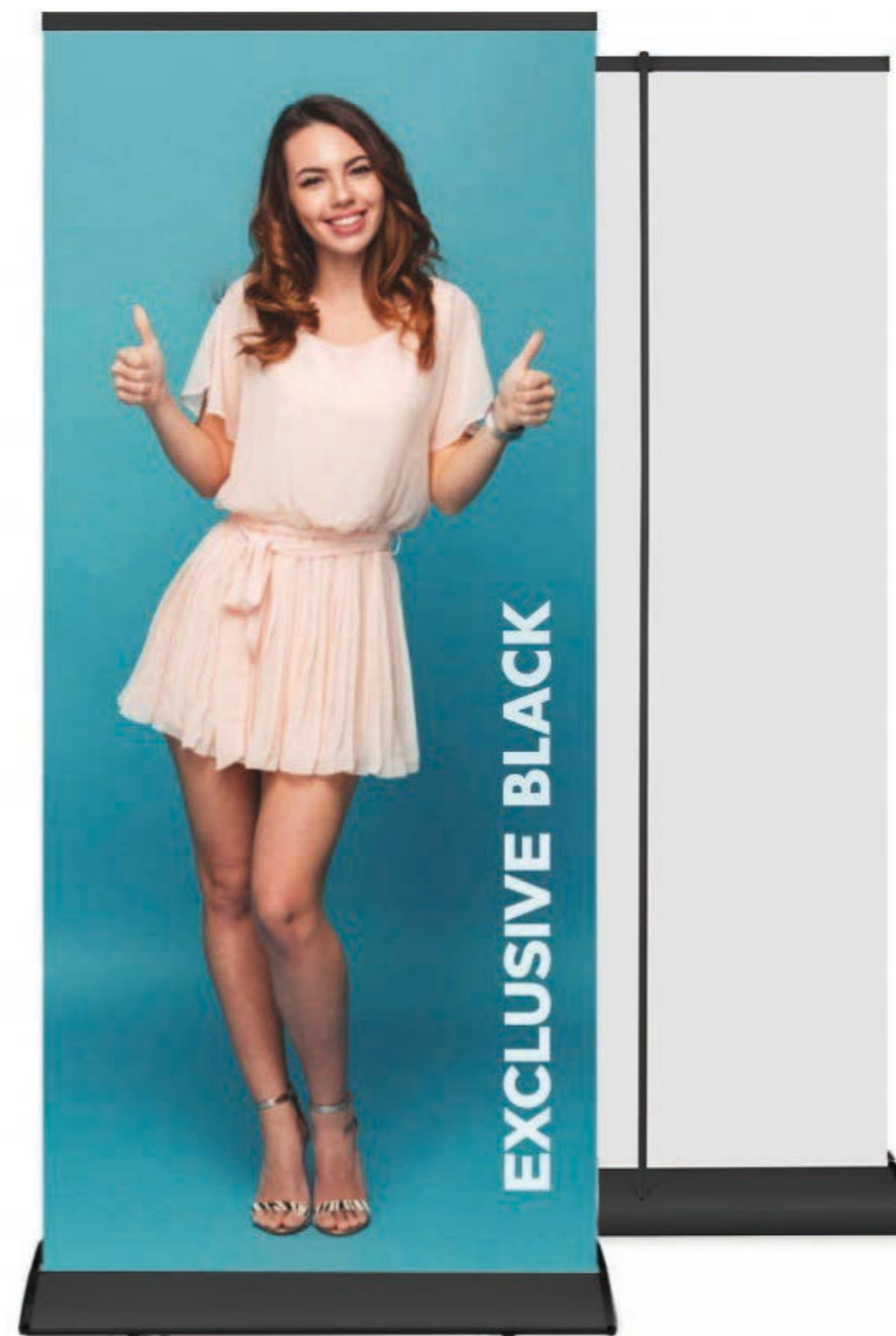
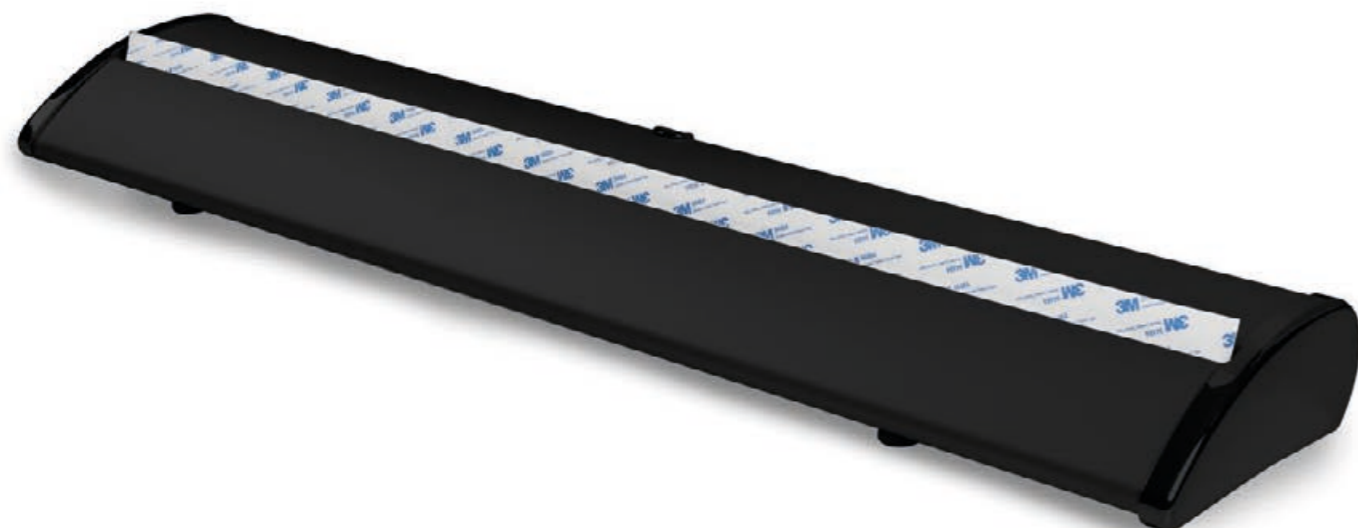

- wyjątkowo elegancki wygląd
- bardzo ciężka, stabilna kasetka
- listwa „Express Clip” – błyskawiczny i łatwy montaż wydruku
- elegancka torba z długim zapięciem

Zestaw zawiera: kasetę typu Exclusive, maszt, listwę zatrzaskową „Express clip”, taśmę 3M, torbę transportową z okienkiem na wizytówkę, indywidualny karton.

- elegant appearance
- heavy and very stable product
- “Express Clip” top bar – quick and easy print assembly
- elegant carrying bag with a long zipper

This set includes: Exclusive roll up cassette, pole, “Express Clip” top bar, 3M adhesive tape, bag with a business card pocket, individual box.

85x200	5907451666982	2,7 kg
100x200	5907451666975	3,2 kg

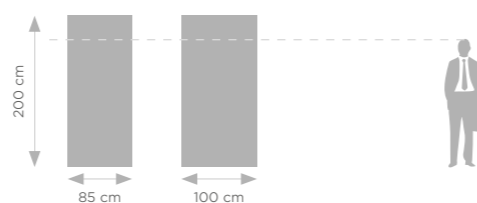

Rekomendowana technologia druku:



WAVE

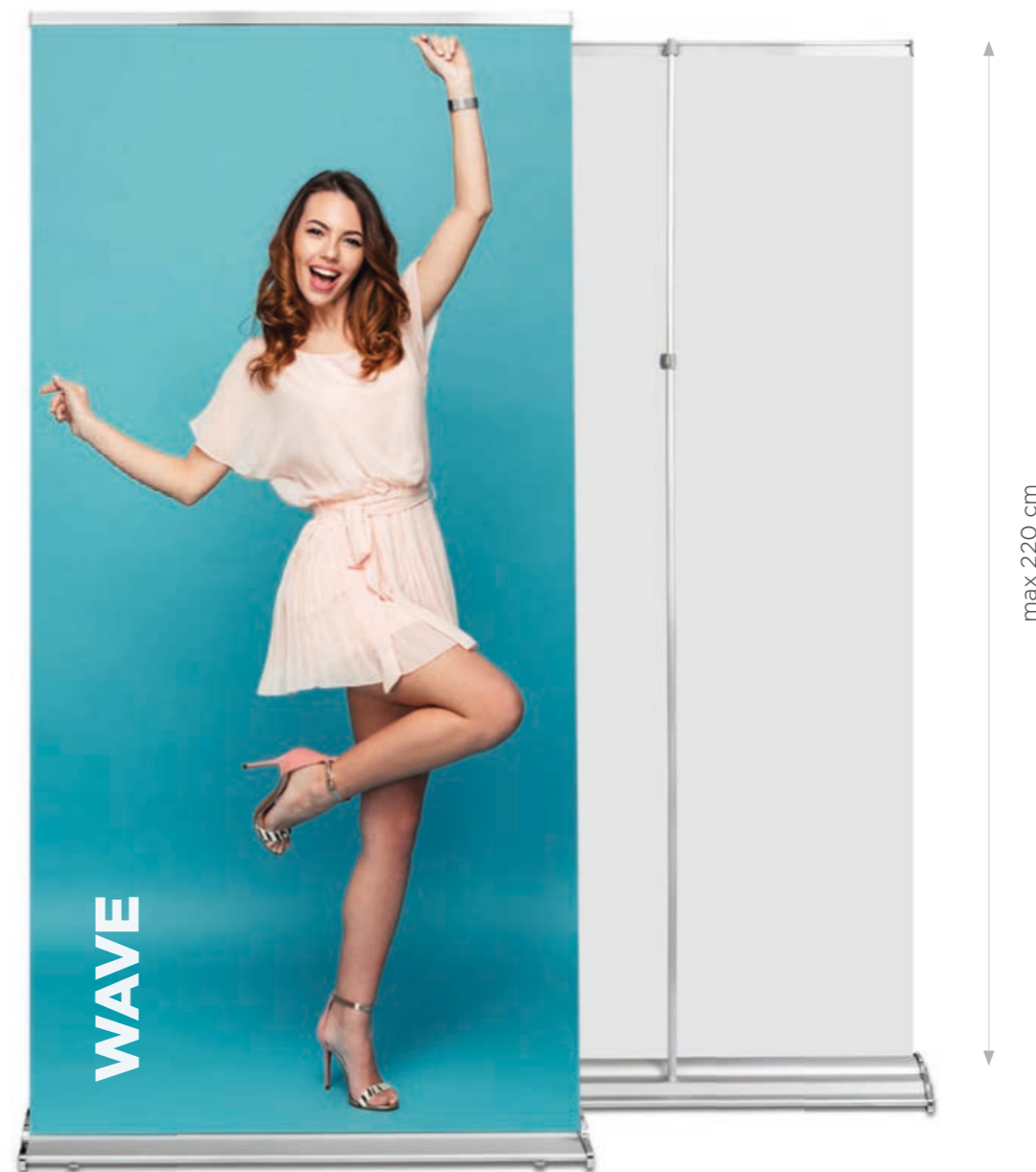

- regulowany maszt do 220 cm
- system wymiany grafiki
- elegancki, niecodzienny wygląd
- listwa „Express Clip” – błyskawiczny i łatwy montaż wydruku
- torba z długim zapięciem

Zestaw zawiera: kasetę typu WAVE, maszt (rozmiary 120×200 i 150×200 posiadają dwa maszty, rozmiar 200×200 posiada trzy maszty), listwę zatrzaskową „Express clip”, system wymiany grafiki, torbę transportową z okienkiem na wizytówki, indywidualny karton.

85×200	5907451665831	2,6 kg
100×200	5907451665848	3,1 kg
120×200	5907451665855	6,2 kg
150×200	5907451665862	7 kg
200×200	5907451665879	7,5 kg

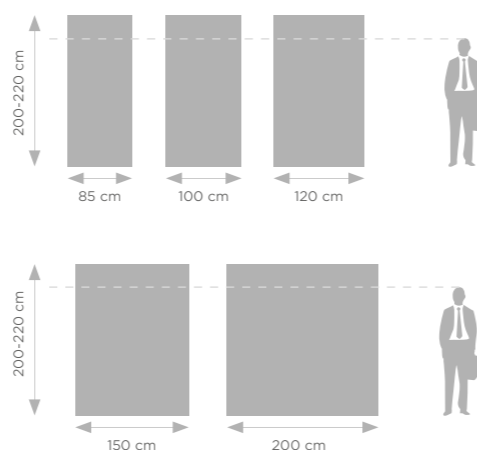

- adjustable pole (up to 220 cm)
- graphics exchange system
- elegant, stylish look
- “Express Clip” top bar – quick and easy print assembly
- padded bag with a long zipper

This set includes: WAVE roll up cassette, pole (sizes 120×200 and 150×200 include 2 poles, size 200×200 includes 3 poles), “Express Clip” top bar, graphics exchange system, padded bag with a business card pocket, individual box.

Rekomendowana technologia druku:



TWIN



- model dwustronny - możliwość prezentacji dwóch różnych wydruków
 - bardzo ciężka, stabilna kasetta
 - listwa „Express Clip” - błyskawiczny i łatwy montaż wydruku
- Zestaw zawiera: kasetę roll up Twin, maszt, listwę zatrzaskową „Express Clip”, taśmę 3M, torbę transportową z okienkiem na wizytówkę, indywidualny karton.

- two-sided roll up model: two separate printouts
 - heavy and very stable product
 - “Express Clip” top bar - quick and easy print assembly
- This set includes: Twin roll up cassette, pole, “Express Clip” top bar, 3M adhesive tape, bag with a business card pocket, individual box.

85x200	5907451660645	4 kg
100x200	5907451660652	4,7 kg

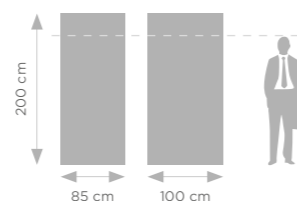

Rekomendowana technologia druku:



STANDARD BLACK



TORBA
LONG ZIP

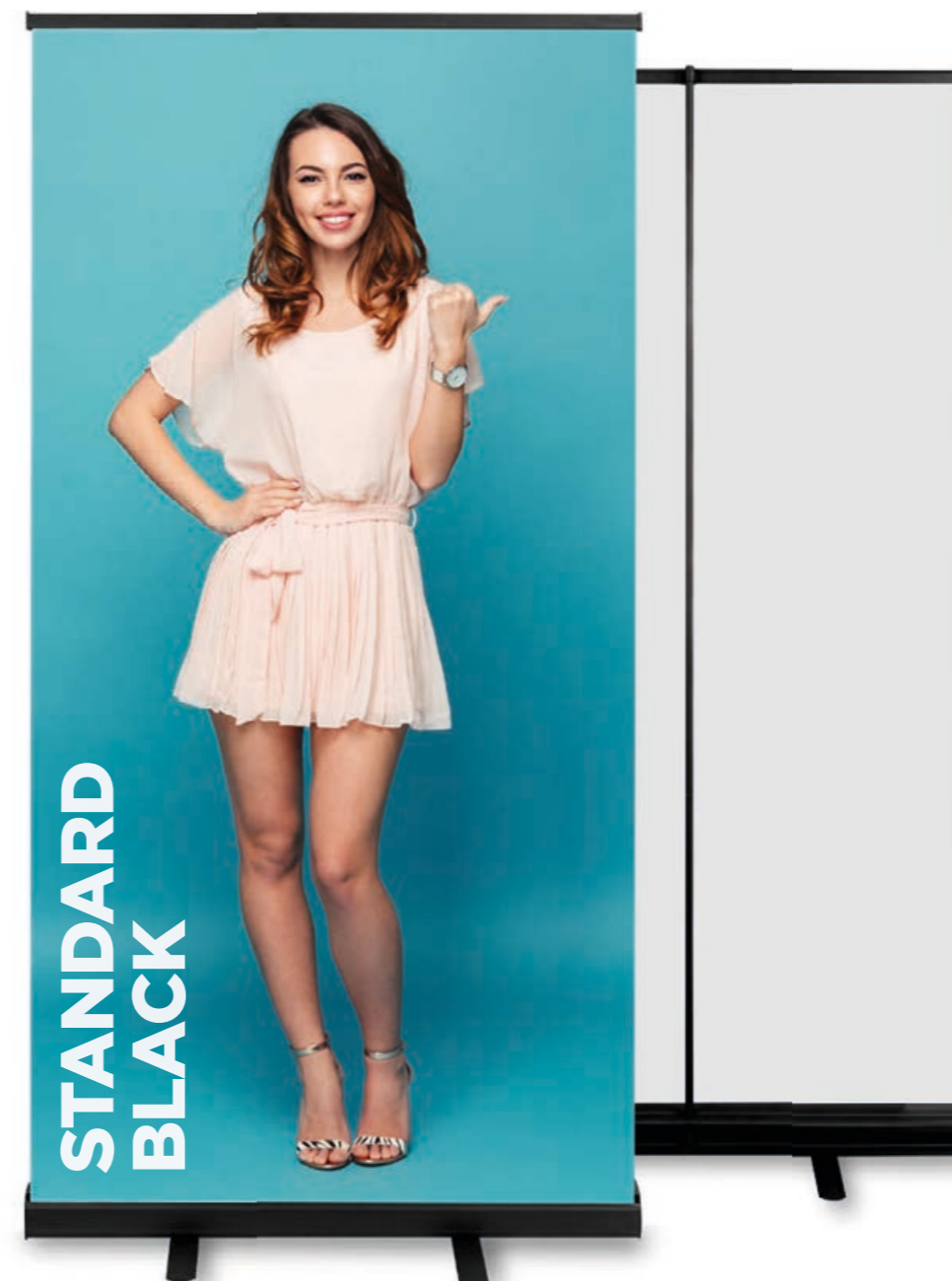
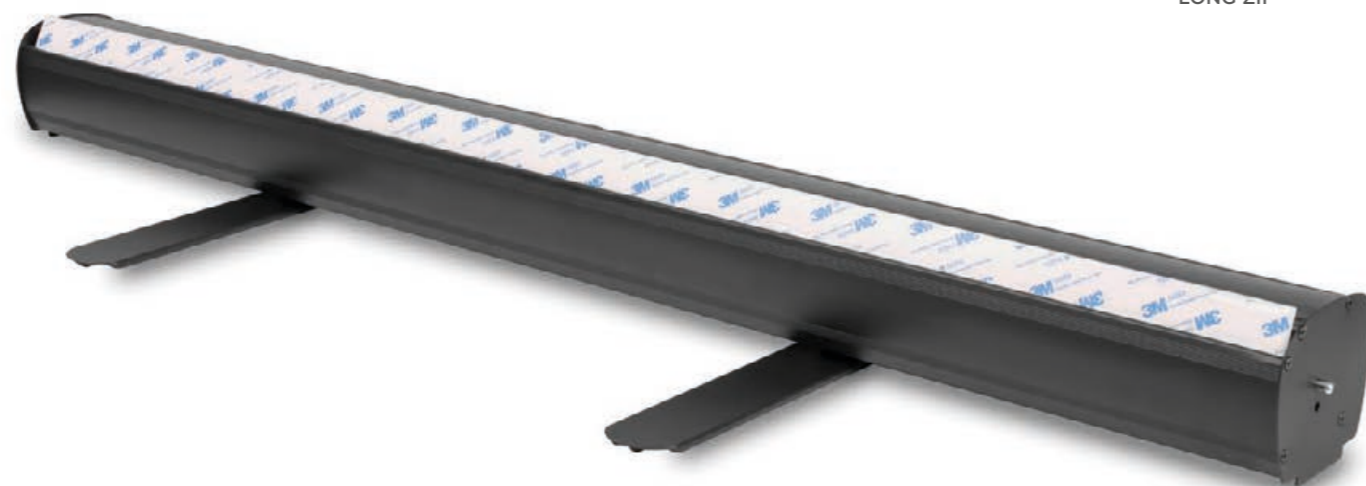

- kolor czarny mat (malowany proszkowo)
- mocna konstrukcja w 100% z anodowanego aluminium
- stabilizator masztu
- listwa „Express Clip” – błyskawiczny i łatwy montaż wydruku
- torba z długim zipem

Zestaw zawiera: kasetę typu Standard Black, maszt, listwę zatrzaskową „Express clip”, taśmę 3M, torbę transportową z okienkiem na wizytówkę, indywidualny karton.

- powder painted black (mat)
- stable, strong construction, 100% made of anodized aluminum
- the pole stabilizer
- “Express clip” top bar – quick and easy print assembly
- transport bag with a long zipper

This set includes: Standard Black roll up cassette, pole, “Express clip” top bar, 3M adhesive tape, bag with a business card pocket, individual box.

85x200	5907451662472	1,60 kg
100x200	5907451662700	1,90 kg

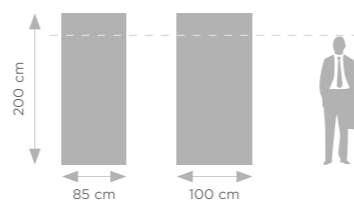

Rekomendowana technologia druku:



Stoplight
Solvent, UV, Latex



Baner powlekany
Solvent, UV, Latex



AKCESORIA DO ROLLUPÓW

OŚWIETLENIE

W przypadku konieczności oświetlenia wydruku, doskonale sprawdzą się nasze lampki, montowane bezpośrednio na maszynie roll up'ów. Dostępne są dwa warianty: w technologii LED i halogen. Zdecydowanie poprawią estetykę i odbiór grafiki.

If you need to illuminate the printout, our lamps, mounted directly on the roll-up pole, will be a perfect solution. Two variants are available: in LED and halogen technology. They will definitely improve the aesthetics of graphics.

HALOGEN



5907451669945



0,3 kg

LED



5907451669938



0,3 kg

BLOCKOUTY



- wysoka jakość
- materiał nie przepuszcza światła
- matowa powierzchnia zapobiega pojawianiu się niechcianych refleksów
- wysoka gramatura

- high class materials
- materials do not let light through
- opaque surface prevents unwanted reflexes
- high density and thickness

	Szerokość (m)	Barcode
Premium 330 g	0,914	5907451663219
Premium 330 g	1,07	5907451663226
Premium 330 g	1,27	5907451663233
Premium 330 g	1,52	5907451663240
Premium B1 FR (trudnopalny) 330 g	0,914	5907451667316
Premium B1 FR (trudnopalny) 330 g	1,07	5907451667323
Premium B1 FR (trudnopalny) 330 g	1,27	5907451667293
PVC Free 300 g	0,914	5907451663257
PVC Free 300 g	1,07	5907451667309



STANDY

X-BANNER COMPACT

- bardzo niski koszt systemu
- prosty sposób obsługi
- ultralekka konstrukcja wykonana z włókna szklanego

Zestaw zawiera: system X-banner, prostą torbę transportową.

- low cost system
- simple handling
- ultralight construction made of fiberglass

This set includes: complete X-banner system and a simple bag.



60x160	5907451660195	0,6 kg
80x180	5907451660201	0,8 kg

Rekomendowana technologia druku:

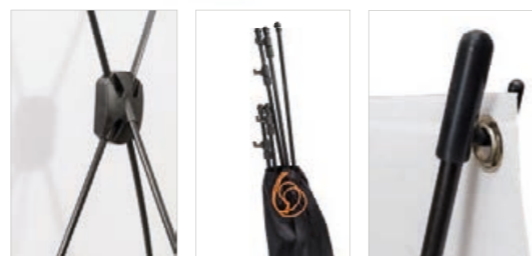
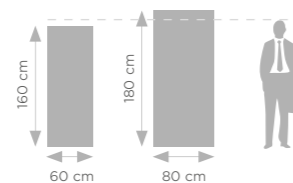

X-BANNER STANDARD

- ulepszona wersja systemu X-banner
- konstrukcja wykonana z metalu malowanego na czarno oraz włókna szklanego
- wysoka jakość
- ultralekka konstrukcja łatwa do przenoszenia i użytku

Zestaw zawiera: system X-banner, torbę transportową, w którą zmieści się również wydruk.

- improved model of X-banner system
- construction made of metal painted in black and fiberglass
- high quality
- ultralight, easy to carry and use

This set includes: complete X-banner system and a bag (the print-out also can fit in).



60x160	5907451660218	1,3 kg
80x180	5907451660225	1,4 kg
120x210	5907451660232	1,7 kg

Rekomendowana technologia druku:

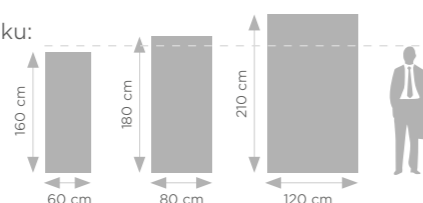

L-BANNER

- bardzo niski koszt systemu
- prosty sposób obsługi
- ultralekki
- w ofercie wersja jedno i dwustronna

Zestawy zawierają: system L-banner, prostą torbę transportową, w którą zmieści się również wydruk.

- low cost system
- simple handling
- ultralight
- single and double sided version available

These sets include: complete L-banner system and a simple bag (the printout also can fit in).

Rekomendowana technologia druku:



L-BANNER PREMIUM



85x210	5907451660669	1,4 kg
--------	---------------	--------

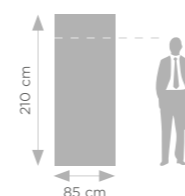

L-BANNER PREMIUM TWIN



85x210	5907451660683	2,40 kg
100x210	5907451660690	2,70 kg

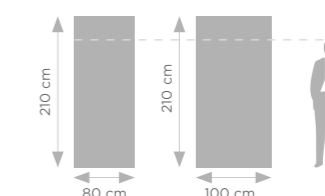

ATLANTIS EXPO

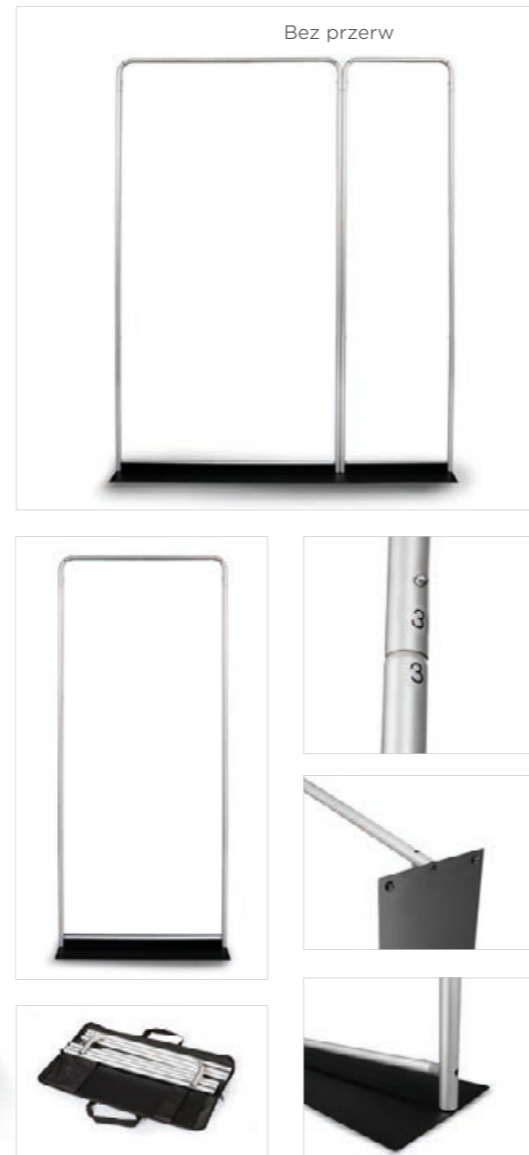

- podstawa wykonana z metalowej płyty
- **bardzo stabilna konstrukcja (profil - Ø 25 mm)**
- niski koszt systemu
- prosty sposób obsługi
- system dwustronny

Zestaw zawiera: system Expo, torbę transportową, w którą zmieści się również wydruk.

- base made of metal plate
- **very stable construction (profile - Ø 25 mm)**
- value for money
- simple handling
- double-sided system

This set includes: complete Expo system and a bag (the printout also can fit in).

60x230	5907451660409	4,30 kg
90x230	5907451660416	5,60 kg
120x230	5907451660423	8,00 kg
150x230	5907451660430	9,70 kg

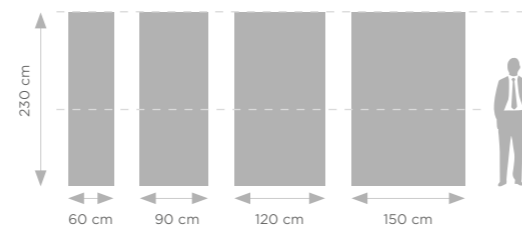

Rekomendowana technologia druku:



Tkanina
Druk sublimacyjny



ŚCIANKI REKLAMOWE

SYSTEM MEGA SEG™



WSTĘPNIE ZŁOŻONA KONSTRUKCJA



ULTRALEKKI SYSTEM



MOŻLIWOŚĆ ŁĄCZENIA



MONTAŻ BEZ NARZĘDZI



SYSTEM DWUSTRONNY



WYDRUK NA TKANINIE (MONTAŻ NA TAŚMIE SILIKONOWEJ)



- ultralight, double-sided, modular system
- wstępnie złożona konstrukcja oparta na zawiasach = błyskawiczne rozłożenie systemu**
- alumiuniowa rama (4,2 cm)
- montaż bez narzędzi
- grafika montowana za pomocą taśmy silikonowej
- kilka ścianek = 1 wydruk!**

Zestaw zawiera: system MEGA SEG, zestaw konektorów (szeregowe - 4 szt., górny - 1 szt., dolny - 1 szt.), torbę transportową.

- ultralight, double-sided, modular system
- pre-assembled hinge-based construction = express unfolding**
- aluminium frame (4,2 cm)
- no tools assembly
- graphics mounted with silicone tape
- several walls - one printout!**

The set includes: MEGA SEG system, a set of connectors (parallel - 4 pieces, top - 1 piece, bottom - 1 piece), transport bag.

SYSTEMY MEGA SEG WYRÓŻNIA WSTĘPNIE ZŁOŻONA KONSTRUKCJA, KTÓRĄ WYSTARCZY OTWORZYĆ.

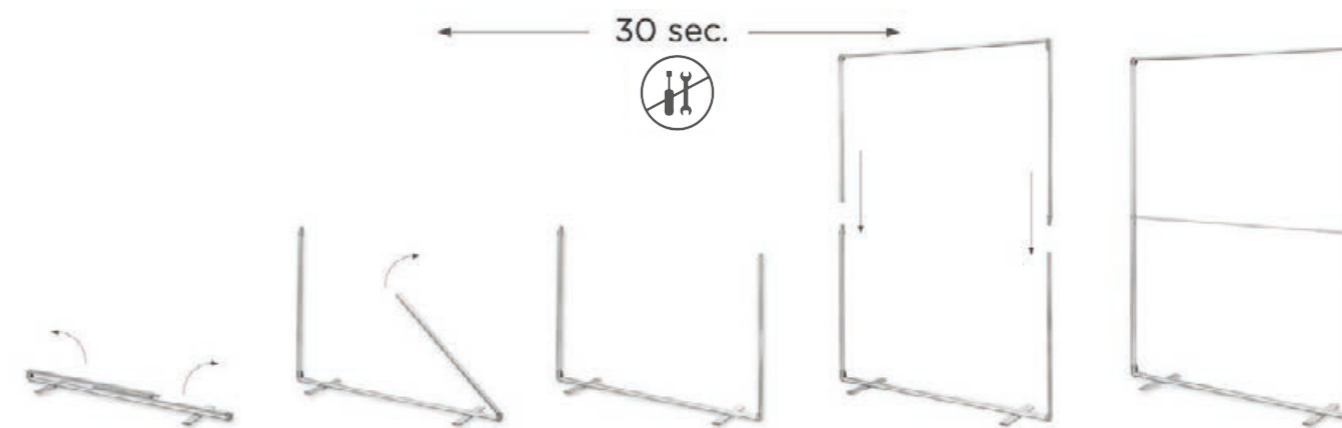

MEGA SEG MOŻESZ ŁĄCZYĆ ZE SOBĄ ZA POMOCĄ DEDYKOWANYCH KONEKTORÓW. DAJE TO NIEOMIAR NIEOGRANICZONE MOŻLIWOŚCI TWORZENIA SYSTEMÓW RÓŻNYCH Kształtów. SZEREGOWE ŁĄCZENIE PRODUKTÓW POZWALA NA NAŁOŻENIE JEDNEGO WYDRUKU NA KILKA POŁĄCZONYCH ZE SOBĄ ŚCIANEK - BEZ WIDOCZNYCH PRZERW MIĘDZY SYSTEMAMI!

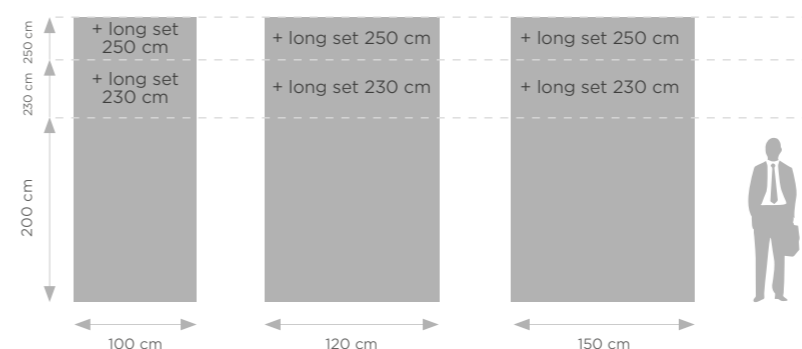

100×200	5907451668948	2,1 kg
120×200	5907451668931	2,6 kg
150×200	5907451668924	3,2 kg

Rekomendowana technologia druku:

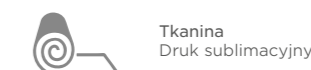

Za pomocą zestawów Long Set podwyższysz produkty MEGA SEG do 230 lub 250 cm.

POP-UP PROSTA

BEST SELLER

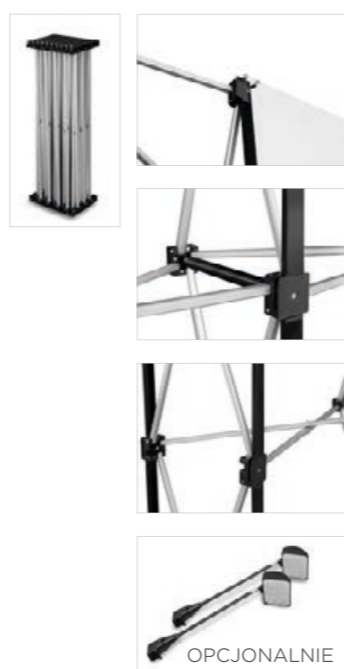

- dobry stosunek ceny do jakości
 - mechanizm „pop up” - błyskawiczne rozłożenie systemu
 - wymienne bryty
- Zestaw zawiera: stelaż Pop-up, komplet listew konstrukcyjnych, komplet listew samoklejących 3M górnych do montażu brytów, taśmę magnetyczną 3M, komplet brytów do grafiki.

- the best value for money
 - “pop up” mechanism - express unfolding
 - interchangeable britches
- This set includes: Pop-up frame, set of construction bars, set of upper 3M magnetic bars, 3M magnetic tape, set of PVC boards.

3x3 (w walizce)	5907451660317	24 kg
3x3 (w ambonie)	5907451666081	24 kg
3x4 (w walizce)	5907451660324	28 kg
3x4 (w ambonie)	5907451666098	28 kg

Walizka i ambona - strona 66

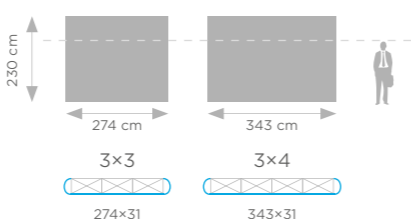

Rekomendowana technologia druku:



POP-UP ŁUKOWA

BEST SELLER



- dobry stosunek ceny do jakości
- mechanizm „pop up” - błyskawiczne rozłożenie systemu
- wymienne bryty

Zestaw zawiera: stelaż Pop-up, komplet listew konstrukcyjnych, komplet listew samoklejących 3M górnych do montażu brytów, taśmę magnetyczną 3M, komplet brytów do grafiki.

- the best value for money
- “pop up” mechanism - express unfolding
- interchangeable britches

This set includes: Pop-up frame, set of construction bars, set of upper 3M magnetic bars, 3M magnetic tape, set of PVC boards.

3x3 (w walizce)	5907451660331	24 kg
3x3 (w ambonie)	5907451666104	24 kg
3x4 (w walizce)	5907451660348	28 kg
3x4 (w ambonie)	5907451666111	28 kg

Walizka i ambona - strona 66

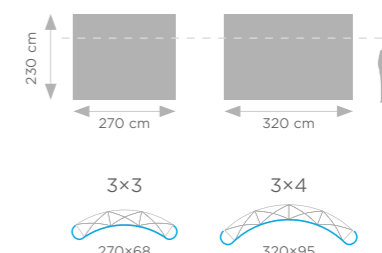

Rekomendowana technologia druku:



STANDARD MAGNETIC POP-UP PROSTA

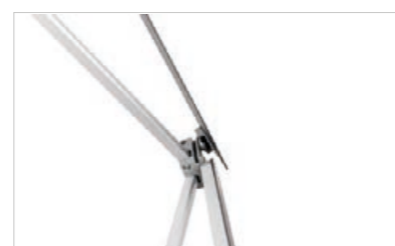

- system szybkiego łączenia elementów za pomocą wbudowanych magnesów
- system „pop up” - błyskawiczny montaż i demontaż
- wymienne bryty

Zestaw zawiera: stelaż Standard Magnetic Pop-up, komplet magnetycznych listew konstrukcyjnych, komplet listew samoklejących 3M górnych do montażu brytów, taśmę magnetyczną 3M, komplet brytów do grafiki.

- special system of fast assembling element using built-in magnets
- “pop up” mechanism - express unfolding
- interchangeable britches

This set includes: Standard Magnetic Pop-up frame, set of magnetic construction bars, set of upper 3M magnetic bars, 3M magnetic tape, set of PVC boards.

3x3 (w walizce)	5907451661024	22 kg
3x3 (w ambonie)	5907451665985	22 kg
3x4 (w walizce)	5907451661031	26 kg

Walizka i ambona - strona 66

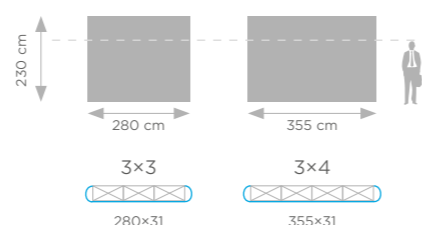

Rekomendowana technologia druku:



STANDARD MAGNETIC POP-UP ŁUKOWA

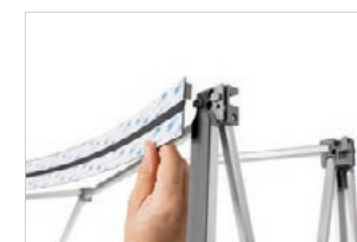

- system szybkiego łączenia elementów za pomocą wbudowanych magnesów
- system „pop up” - błyskawiczny montaż i demontaż
- wymienne bryty

Zestaw zawiera: stelaż Standard Magnetic Pop-up, komplet magnetycznych listew konstrukcyjnych, komplet listew samoklejących 3M górnych do montażu brytów, taśmę magnetyczną 3M, komplet brytów do grafiki.

- special system of fast assembling element using built-in magnets
- “pop up” mechanism - express unfolding
- interchangeable britches

This set includes: Standard Magnetic Pop-up frame, set of magnetic construction bars, set of upper 3M magnetic bars, 3M magnetic tape, set of PVC boards.

3x3 (w walizce)	5907451660959	22 kg
3x3 (w ambonie)	5907451665961	22 kg
3x4 (w walizce)	5907451660966	26 kg
3x4 (w ambonie)	5907451665978	26 kg

Walizka i ambona - strona 66

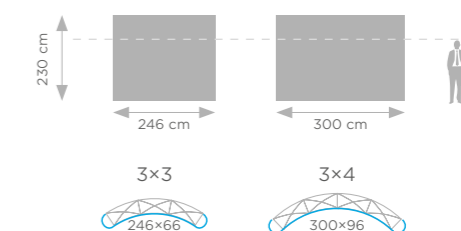

Rekomendowana technologia druku:



PREMIUM MAGNETIC POP-UP PROSTA

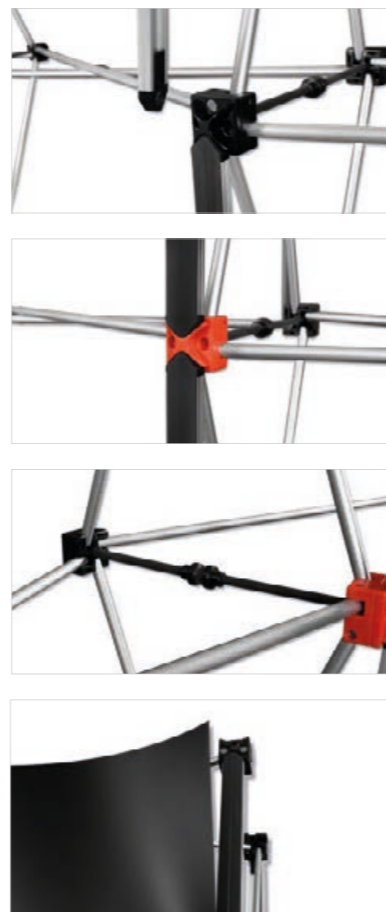
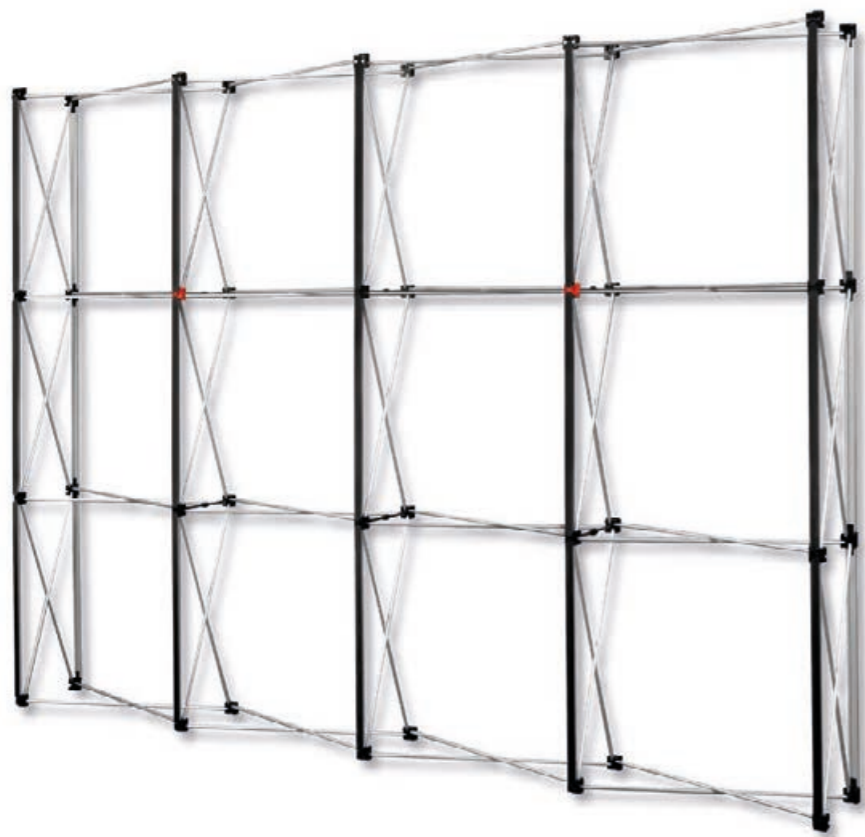

- bardzo wysoka jakość wykonania
- system „pop up” - błyskawiczne rozłożenie ścianki
- magnetyczny montaż listew konstrukcyjnych i brytów
- wymienne bryty
- ambona w zestawie

Zestaw zawiera: stelaż Premium Magnetic Pop-up, listwy mocujące bryty, komplet listew konstrukcyjnych, komplet brytów, ambonę na kółkach.

- high quality of construction
- “pop up” mechanism - express unfolding
- magnetic installation system
- interchangeable britches
- case counter

The set includes: Premium Magnetic Pop-up frame, top bars with adhesive tape for mounting PVC panels, a set of construction bars, a set of PVC panels, case counter.

3x3	5907451666364	27 kg
3x4	5907451666371	31 kg

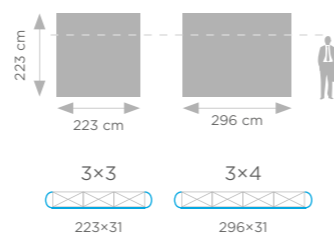

Rekomendowana technologia druku:



PREMIUM MAGNETIC POP-UP ŁUKOWA

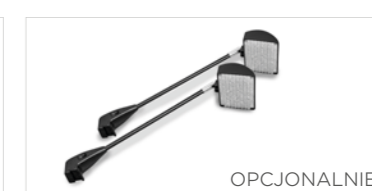
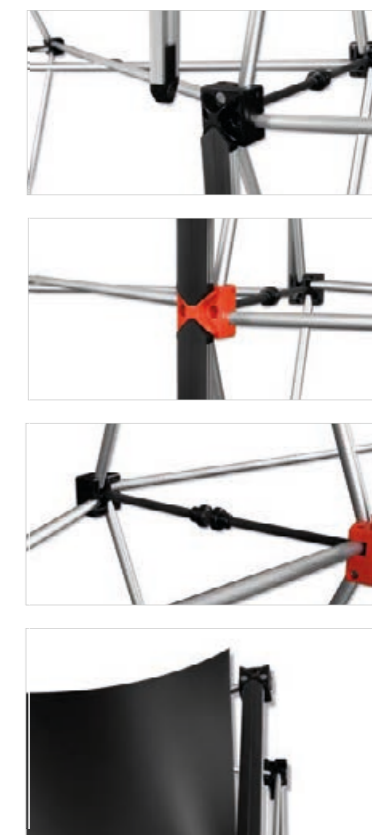
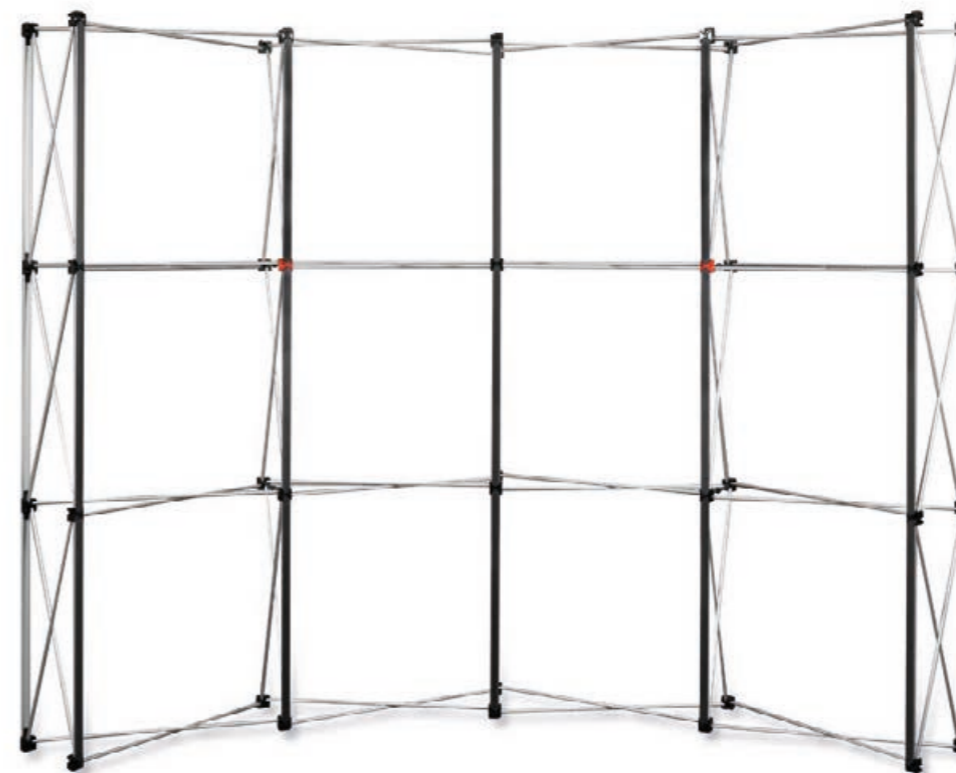

- bardzo wysoka jakość wykonania
- system „pop up” - błyskawiczne rozłożenie ścianki
- magnetyczny montaż listew konstrukcyjnych i brytów
- wymienne bryty
- ambona w zestawie

Zestaw zawiera: stelaż Premium Magnetic Pop-up, listwy mocujące bryty, komplet listew konstrukcyjnych, komplet brytów, ambonę na kółkach.

- high quality of construction
- “pop up” mechanism - express unfolding
- magnetic installation system
- interchangeable britches
- case counter

The set includes: Premium Magnetic Pop-up frame, top bars with adhesive tape for mounting PVC panels, a set of construction bars, a set of PVC panels, case counter.

3x3	5907451666388	27 kg
3x4	5907451666395	31 kg

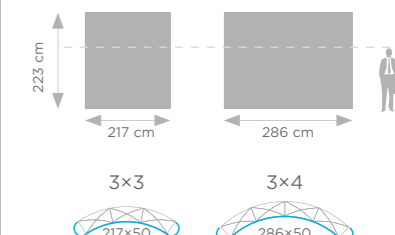

Rekomendowana technologia druku:



BLACK PRO MAGNETIC POP-UP PROSTA

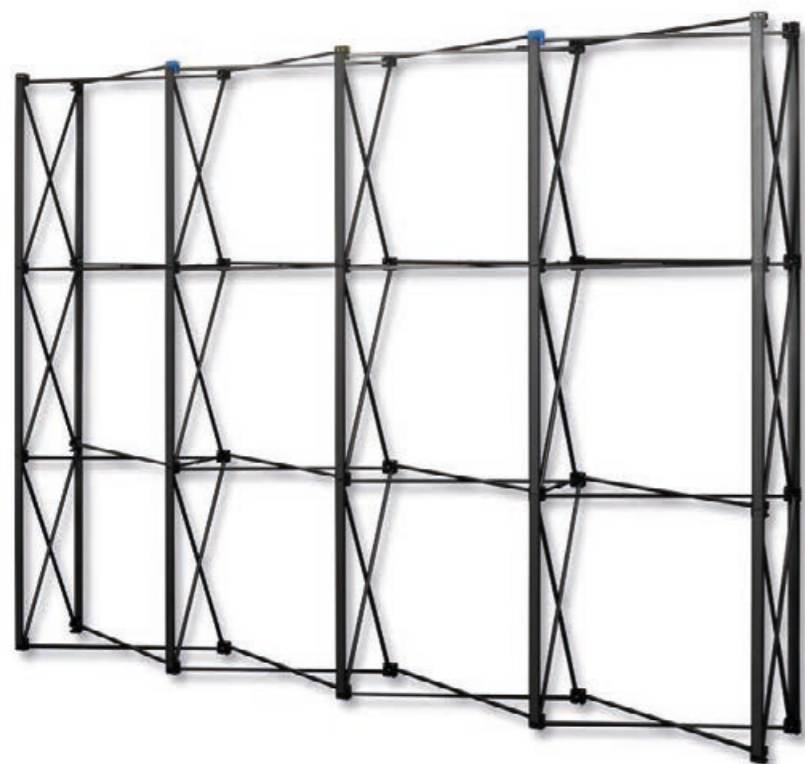

- bardzo wysoka jakość wykonania
- podwójne magnesy
- system „pop up” – błyskawiczne rozłożenie ścianki
- magnetyczny montaż listew konstrukcyjnych i brytów
- wymienne bryty
- ambona w zestawie

Zestaw zawiera: stelaż Black Pro Magnetic Pop-up, listwy mocujące bryty, komplet listew konstrukcyjnych, komplet brytów, ambonę na kółkach.

- high quality of construction
- “pop up” mechanism – express unfolding
- magnetic installation system
- interchangeable britches
- case counter

The set includes: Black Pro Magnetic Pop-up frame, top bars with 3M adhesive tape for mounting PVC panels, a set of construction bars, a set of PVC panels, case counter.

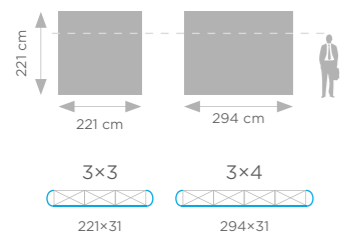

3x3	5907451666319	31 kg
3x4	5907451666326	34 kg

Rekomendowana technologia druku:



Folia Solvent, UV, Latex

OPCJONALNIE

BLACK PRO MAGNETIC POP-UP ŁUKOWA

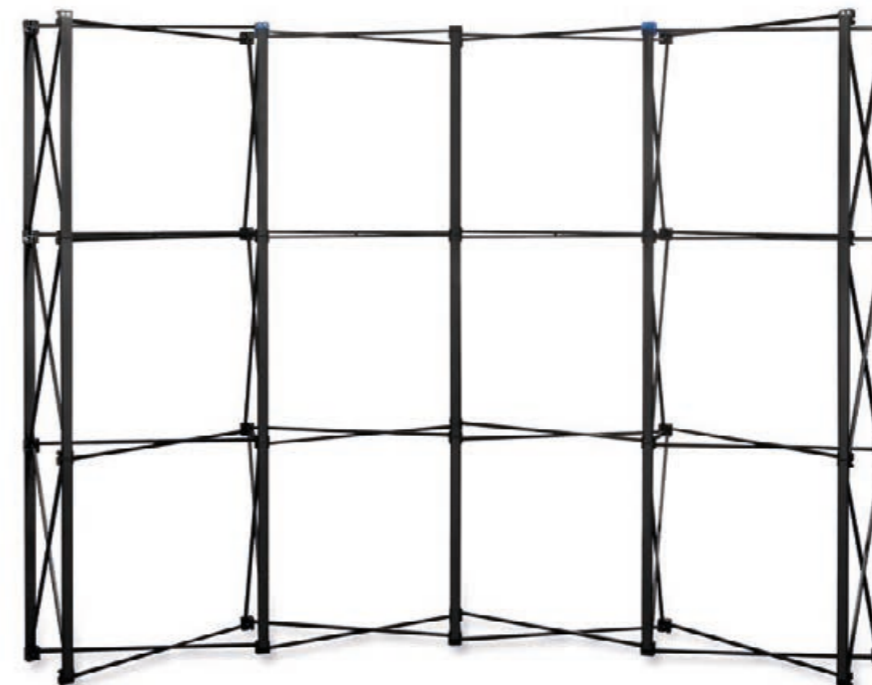

- bardzo wysoka jakość wykonania
- podwójne magnesy
- system „pop up” – błyskawiczne rozłożenie ścianki
- magnetyczny montaż listew konstrukcyjnych i brytów
- wymienne bryty
- ambona w zestawie

Zestaw zawiera: stelaż Black Pro Magnetic Pop-up, listwy mocujące bryty, komplet listew konstrukcyjnych, komplet brytów, ambonę na kółkach.

- high quality of construction
- “pop up” mechanism – express unfolding
- magnetic installation system
- interchangeable britches
- case counter

The set includes: Black Pro Magnetic Pop-up frame, top bars with 3M adhesive tape for mounting PVC panels, a set of construction bars, a set of PVC panels, case counter.

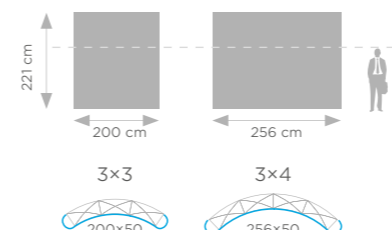

3x3	5907451666333	31 kg
3x4	5907451666340	34 kg

Rekomendowana technologia druku:



Folia Solvent, UV, Latex

OPCJONALNIE

VELCRO POP-UP PROSTA



OPCJONALNIE

- ścianka przeznaczona do montażu grafik tekstylnych bez użycia brytów
- grafika w jednej części, bez podziału na bryty
- mechanizm „pop up” - błyskawiczne rozłożenie systemu

Zestaw zawiera: stelaż Velcro Pop-up, taśmę rzep do wszycia w grafikę, torbę typu Canvas.

- wall designed for mounting textile graphics on it, using Velcro tape
- one piece graphics without PVC boards
- “pop up” mechanism - express unfolding

This set includes: Velcro Pop-up frame, Velcro tape, Canvas bag.

3x3	5907451660973	8,5 kg
3x4	5907451660980	10 kg

229 cm	303 cm	
226 cm		
3x3	3x4	
226x30	303x30	

Rekomendowana technologia druku:

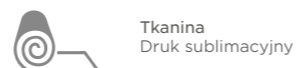

VELCRO POP-UP ŁUKOWA



OPCJONALNIE

- ścianka przeznaczona do montażu grafik tekstylnych bez użycia brytów
- grafika w jednej części, bez podziału na bryty
- mechanizm „pop up” - błyskawiczne rozłożenie systemu

Zestaw zawiera: stelaż Velcro Pop-up, taśmę rzep do wszycia w grafikę, torbę typu Canvas.

- wall designed for mounting textile graphics on it, using Velcro tape
- one piece graphics without PVC boards
- “pop up” mechanism - express unfolding

This set includes: Velcro Pop-up frame, Velcro tape, Canvas bag.

3x3	5907451660997	8,5 kg
3x4	5907451661000	10 kg

226 cm	280 cm	
210 cm		
3x3	3x4	
210x68	280x95	

Rekomendowana technologia druku:

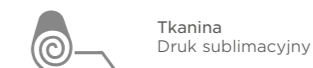

ATLANTIS PROSTA



- mała i lekka konstrukcja
- duża powierzchnia prezentacji grafiki
- dwustronna grafika zakładana na zasadzie „naciągania skarpety”
- szybki montaż
- dobry stosunek jakości do ceny

Zestaw zawiera: stelaż Atlantis, torbę transportową typu Canvas.

- lightweight, small construction, large graphic presentation surface
- double sided graphic pulled on frame on principle of putting on a sock
- quick assembly
- value for money

This set includes: Atlantis frame and a Canvas bag.

250×230	5907451661109	7 kg
300×230	5907451661116	8 kg
400×230	5907451661123	9 kg
590×230	5907451663769	15 kg

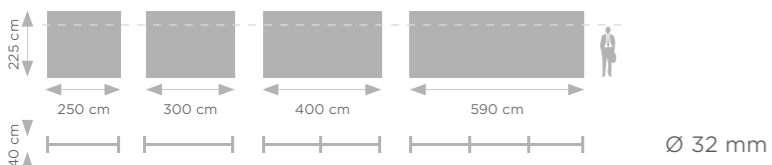

Rekomendowana technologia druku:



Tkanina
Druk sublimacyjny



ATLANTIS ŁUKOWA



- mała i lekka konstrukcja
- duża powierzchnia prezentacji grafiki
- dwustronna grafika zakładana na zasadzie „naciągania skarpety”
- szybki montaż
- dobry stosunek jakości do ceny

Zestaw zawiera: stelaż Atlantis, torbę transportową typu Canvas.

- thanks to the curved sides, part of the graphics is also visible from the side.
- lightweight, small construction, large graphic presentation surface
- double sided graphic pulled on frame on principle of putting on a sock
- quick assembly
- value for money

This set includes: Atlantis frame and a Canvas bag.

250×230	5907451661154	5 kg
300×230	5907451661161	6 kg
400×230	5907451661178	7 kg
530×230	5907451661185	10 kg

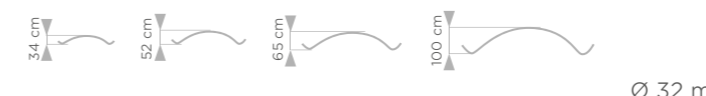
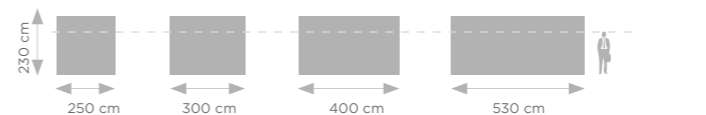

Rekomendowana technologia druku:



Tkanina
Druk sublimacyjny



ATLANTIS S



- mała i lekka konstrukcja
- duża powierzchnia prezentacji grafiki
- dwustronna grafika zakładana na zasadzie „naciągania skarpety”
- szybki montaż
- dobry stosunek jakości do ceny

Zestaw zawiera: stelaż Atlantis, torbę transportową typu Canvas.

- very impressive version of the Atlantis wall
- lightweight, small construction, large graphic presentation surface
- double sided graphic pulled on frame on principle of putting on a sock
- quick assembly
- value for money

This set includes: Atlantis frame, Canvas bag.

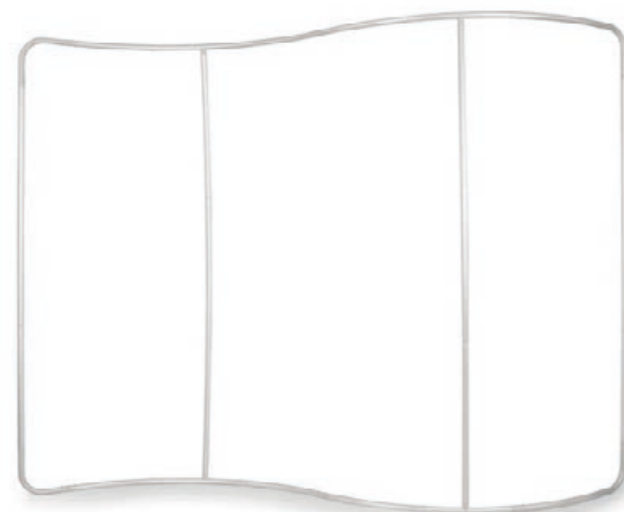

Ø 32 mm



OPCJONALNIE

Rekomendowana technologia druku:



Tkanina Druk sublimacyjny

250×230	5907451663097	5 kg
300×230	5907451661192	6 kg
400×230	5907451661208	7 kg
500×230	5907451661215	9 kg
650×230	5907451661222	11 kg

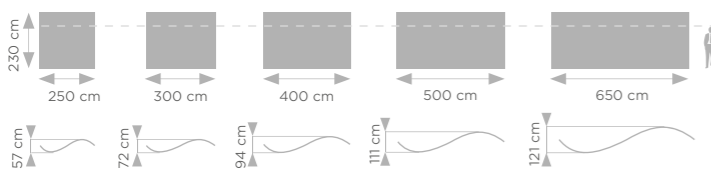

ATLANTIS U

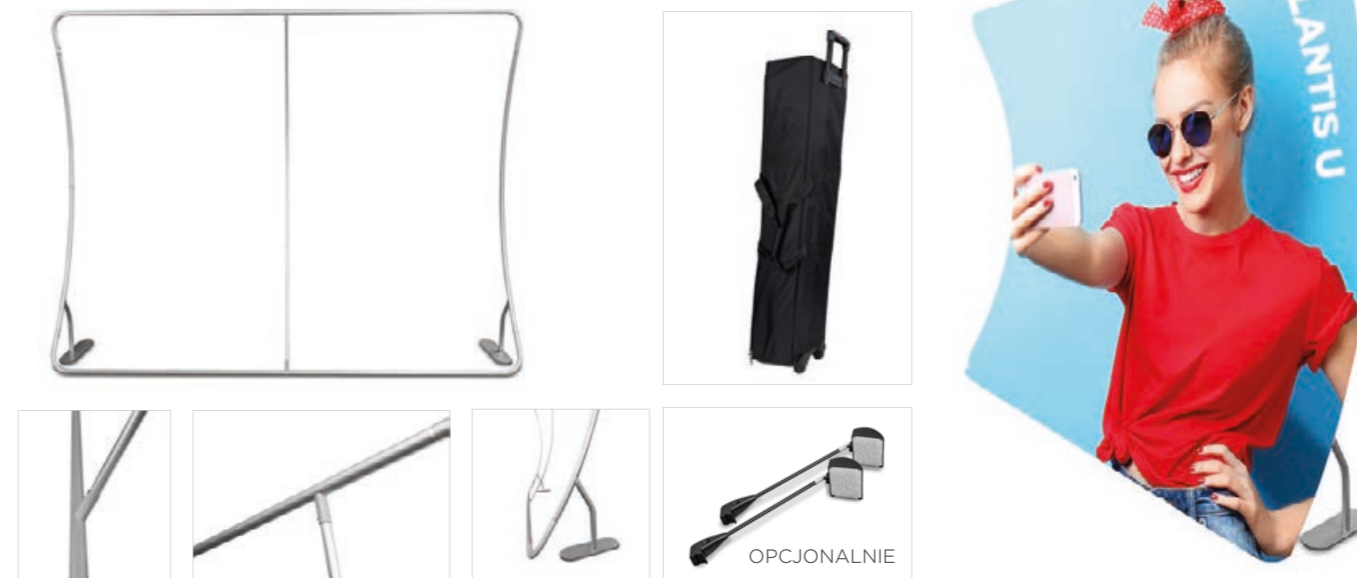

- grafika zakładana na zasadzie „naciągania skarpety”
- stabilna konstrukcja dzięki dodatkowym nogom

Zestaw zawiera: stelaż Atlantis, torbę typu Canvas.

- graphic pulled on frame on principle of putting on a sock
- extra legs make the system very stable

This set includes: Atlantis frame and a Canvas bag.

250×230	5907451669884	5 kg	230 cm
300×230	5907451661239	6 kg	250 cm, 300 cm

Recommended media and printing technology for this system:



Tkanina Druk sublimacyjny

ŚCIANKA KONFERENCYJNA



- idealne rozwiązanie podczas spotkań handlowych
- dwustronna grafika zakładana na zasadzie „naciągania skarpety”

- ideal for separating a private space for meetings
- double sided graphic pulled on frame on principle of putting on a sock

305×150	5907451669860	6,5 kg

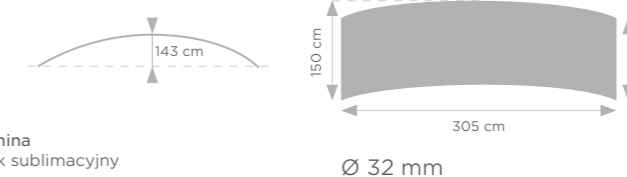

Rekomendowana technologia druku:



Tkanina Druk sublimacyjny



COMBI SYSTEMS

System półek przeznaczony do ścianek Atlantis (prostych). Dzięki temu prostemu rozwiązaniu, każda ścianka może stać się kompletnym, niezależnym i bardzo funkcjonalnym systemem targowym. Doskonale sprawdzi się na stoiskach promocyjnych, edukacyjnych i targowych. System posiada 3 półki poziome w kolorze czarnym, wykonane z grubego tworzywa sztucznego imitującego drewno lub 3 kieszenie na katalogi i ulotki, wykonane z grubego tworzywa pleksi. W górnej części systemu znajduje się tablica, na której można wykonać wydruk (folia) firmowego logo lub innej grafiki.

Shelving system for Atlantis (straight) walls. Thanks to this simple solution, each wall can become a complete, independent and very functional exhibition system. Perfect for promotional, educational and fair stands. The system has 3 horizontal black shelves made of thick plastic imitating wood, or 3 pockets for catalogs and leaflets, made of thick plexiglass. In the upper part of the system, there is a board on which a company logo or other graphics can be printed (Folia).

COMBI 1

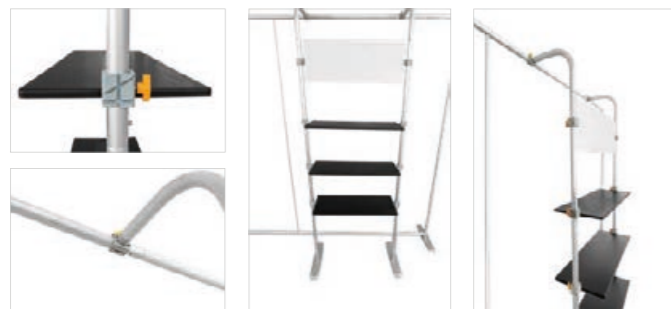

COMBI 2



Zestaw zawiera system COMBI. Ścianki Atlantis należy dokupić osobno.

Combi 1	5907451665039	12 kg
Combi 2	5907451665022	8 kg

VERSUM

- ścianki przeznaczone do grafik bannerowych o dużych powierzchniach
- dobry stosunek jakości do ceny
- regulowana rama, która pozwala uzyskać różne rozmiary
- stabilna konstrukcja

- walls intended for big size frontlit banner graphics
- value for money
- adjustable frame, which can obtain various sizes
- stable construction

Zestawy zawierają: stelaż Versum, torbę transportową.

These sets include: Versum frame and a transport bag.

Rekomendowana technologia druku:



VERSUM

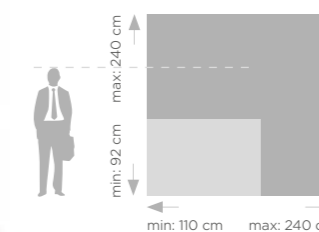

5907451661086	5,8 kg

Stelaż: Ø 22 mm

VERSUM XL

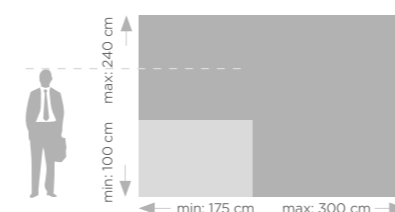
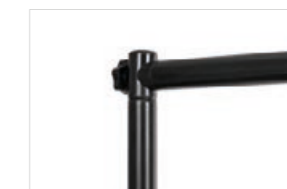

5907451661093	9,5 kg

Stelaż: Ø 32 mm



AKCESORIA DO ŚCIANEK

TORBY I WALIZKI

I AMBONA



- 2w1 - trybunka i torba na kółkach
- doskonały duet prezentacyjny w zestawie ze ścianką
- lakierowany blat jest opcją dodatkową

Zestaw zawiera: ambonę, bryt PCV, taśmę do montażu grafiki na ambonie.

- 2 in 1 - trolley case and a counter
- excellent set together with the wall
- varnished tabletop is an additional option

This set includes: Counter, PVC Panel board and a tape for graphics assembly.

I TORBA CANVAS



Polecana do ścian z grafiką, która nie jest prezentowana na brytach PCV.

Recommended for walls with graphic not presented on PVC boards.

Torba Canvas	5907451662946	1 kg
Walizka na kółkach	5907451660867	5 kg
Ambona	5907451660874	12 kg
Blat do ambony	5907451663073	6 kg

I WALIZKA NA KÓŁKACH



- bardzo trwała dzięki dodatkowej podszewce
- ułatwiony transport dzięki kółkom

- additional padding makes this case very stable
- easy to carry thanks to wheels

OŚWIETLENIE

I HALOGEN



5907451660911

I LED



LED do systemu MEGA SEG	5907451668887
LED do ścianek Pop-up i Atlantis	5907451660928
LED do ścianek Premium Pop-up	5907451666418



STOISKA TARGOWE

LUMIX™

PREMIUM LINE

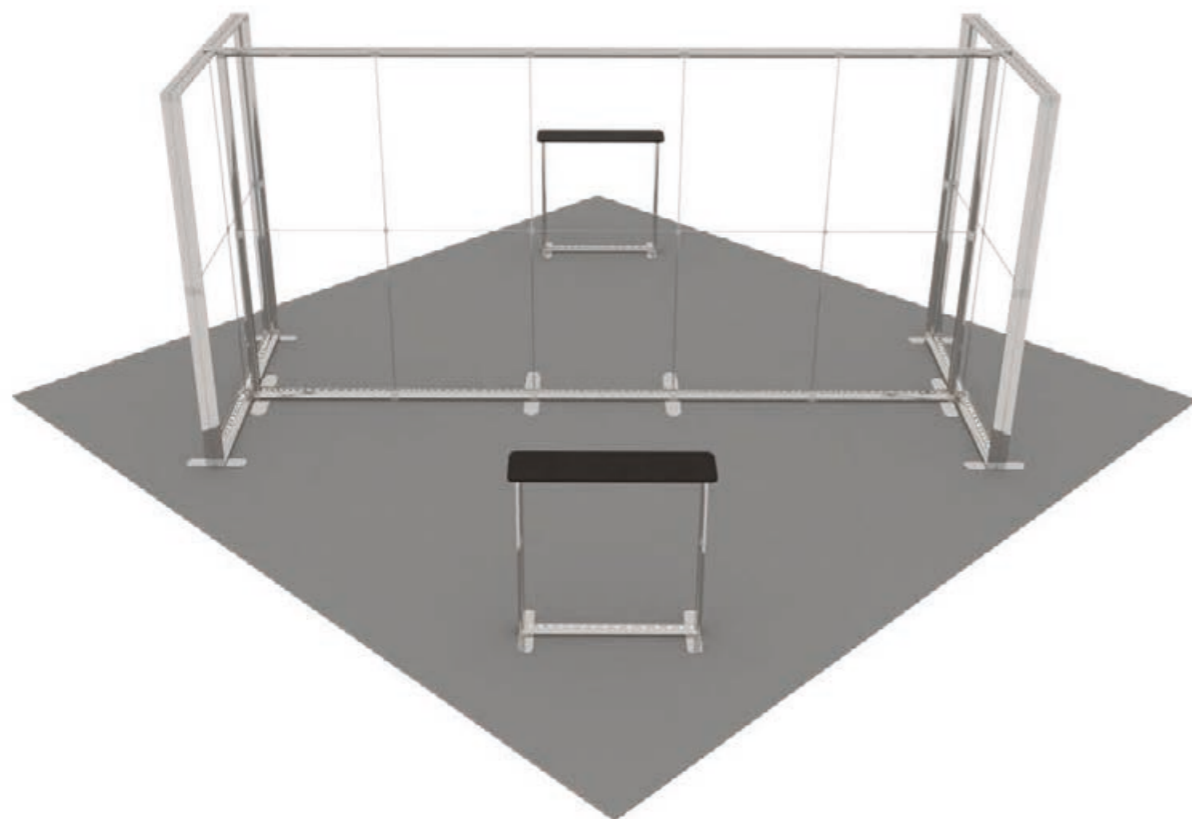

PRZYKŁADOWE UKŁADY STOISK LUMIX



- LED
- SZEROKI PROFIL ALUMINIOWY (12 cm)
- KONSTRUKCJA MODUŁOWA
- DWUSTRONNY SYSTEM
- MONTAŻ BEZ NARZĘDZI
- WYDRUK NA TKANINIE (MONTAŻ NA TAŚMIE SILIKONOWEJ)
- TORBA NA KÓŁKACH

STOISKO TARGOWE LUMIX SKŁADA SIĘ Z SYSTEMU LUMIX (WIĘCEJ NA STRONACH 6-7) ORAZ TRYBUNKI LUMIX (WIĘCEJ NA STRONIE 14)

- spektakularne, podświetlane stoisko targowe
 - szeroki profil aluminiowy (12 cm)
 - montaż bez narzędzi
 - wydruk na tkaninie montowanej na taśmie silikonowej
 - torba na kółkach
- Zestaw zawiera: system LUMIX, trybunkę LUMIX, torbę na kółkach, akcesoria montażowe.
- eye-catching LED exhibition stand
 - wide aluminium profile (12 cm)
 - no tools assembly
 - silicon tape mounted printout
 - sturdy wheeled transport bag
- The set includes: LUMIX system, LUMIX counter, wheeled transport bags, assembly accessories.

16 m ² /wyspawce	5907451667996
25 m ² /wyspawce	5907451667989
36 m ² /wyspawce	5907451667972
9 m ² /półwyspawce	5907451667965
12 m ² /półwyspawce	5907451667941
15 m ² /półwyspawce	5907451667934
16 m ² /półwyspawce	5907451667958
18 m ² /półwyspawce	5907451667910
24 m ² /półwyspawce/1 trybunka	5907451667927
24 m ² /półwyspawce/2 trybunki	5907451667903
9 m ² /narożne	5907451667897
15 m ² /narożne	5907451667859
25 m ² /narożne	5907451667873

Rekomendowana technologia druku:



Tkanina
Druk sublimacyjny

AKCESORIA DO STOISK TARGOWYCH LUMIX™

UCHWYT NA MONITOR

Specjalny uchwyt na monitor pozwala na dodatkową, multimedialną prezentację oferty. To idealna alternatywa dla tradycyjnych plakatów czy banerów, która zwiększa efektywność całego stoiska.

A special monitor holder allows additional multimedia presentation. This is an ideal alternative to traditional posters or banners, which increases the efficiency of the entire booth.



LOCKER SET

Podświetlany schowek z zamkiem na kod to świetne rozwiązanie do przechowywania materiałów potrzebnych podczas targów czy innych wydarzeń promocyjnych.

The illuminated storage room with a code lock is a great solution to store materials needed during trade fairs or other promotional events.



SYSTEM PÓŁEK

Dzięki systemowi półek LUMIX staje się jeszcze bardziej funkcjonalnym systemem targowym czy promocyjnym. Półki możesz zamontować w poziomie lub na ukos.

The shelves system makes the LUMIX products even more functional. The shelves can be mounted horizontally or diagonally.

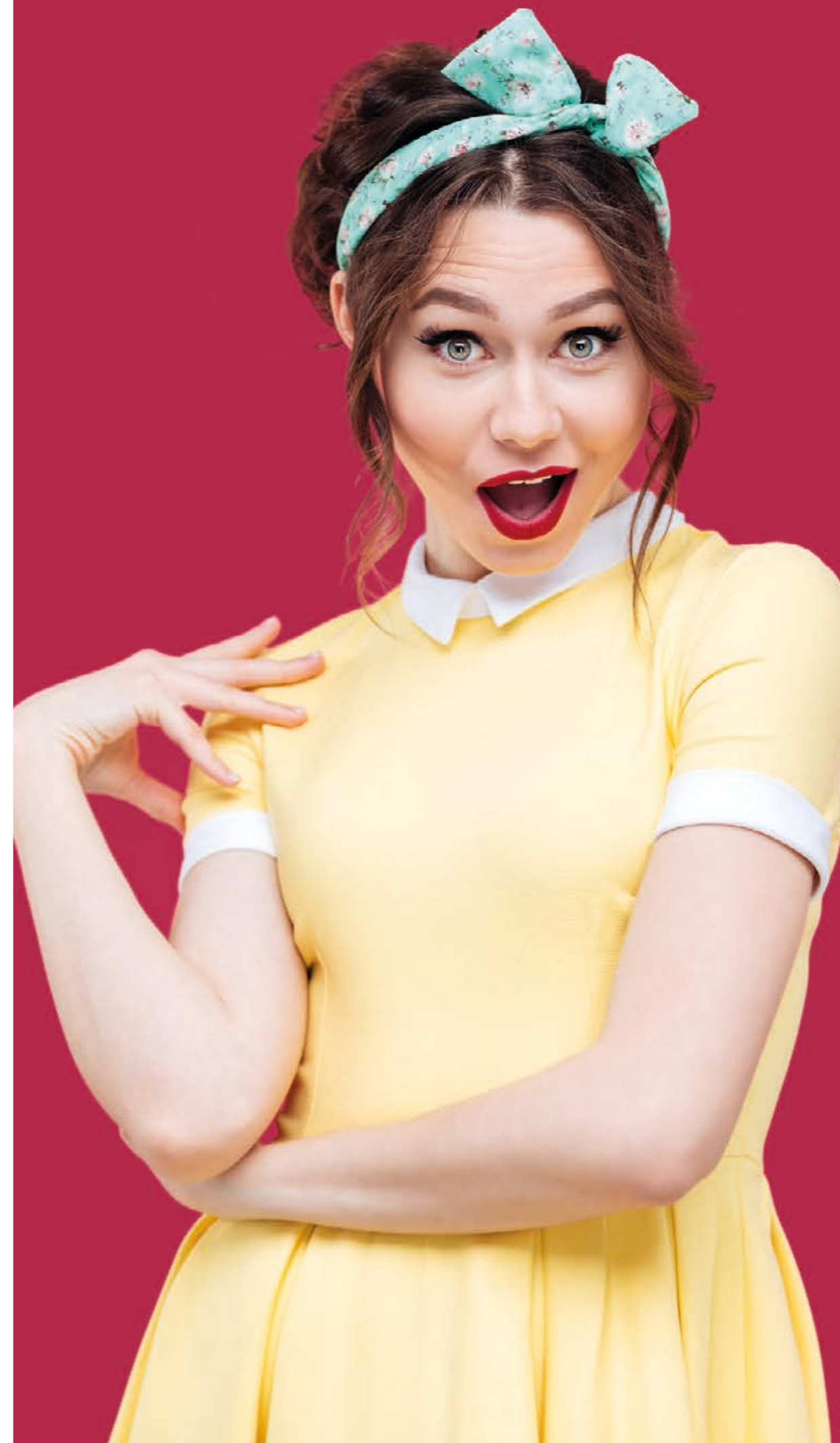

TRYBUNKI
I STOJAKI NA ULOTKI

TRYBUNKI PROMO

- niezwykle prosty montaż
- trybunka składa się z drewnianego blatu i podstawy, które łączy bryt PCV montowany na rzepy
- bardzo lekka konstrukcja

Zestawy zawierają: blat i podstawę zapakowane w torbę transportową, bryt PVC zapakowany w osobną tubę transportową.

- thanks to the simplicity of assembly, they have gained great popularity in many markets
- the walls of this system are made of cellular PVC, mounted to the wooden tabletop and wooden base with velcro straps
- ultralight counter

These sets include: counter top and base packed in transport bag, PVC panel packed in separate transport tube.

Rekomendowana technologia druku:  Folia Solvent, UV, Latex

PROMO 0

NEW STRONG TOP

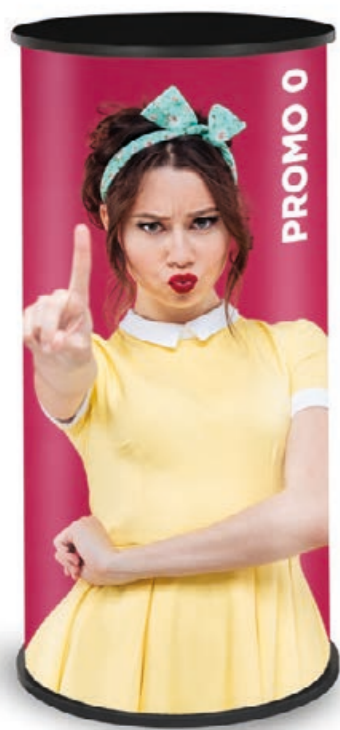

5907451661437



5 kg

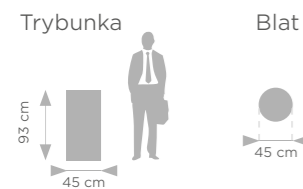

PROMO 1

NEW STRONG TOP



5907451661444



10 kg

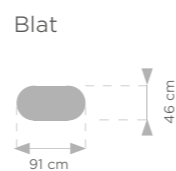
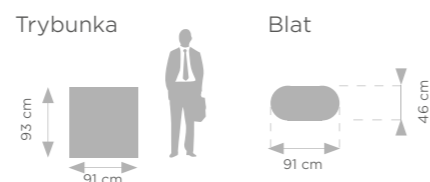

PROMO 2

BEST SELLER

NEW STRONG TOP



Produkt dostępny również z półką.

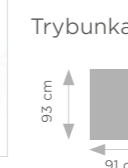

Trybunka

Blat



5907451661451



10 kg

PROMO 3

NEW STRONG TOP

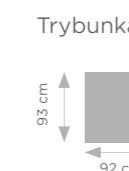

Trybunka

Blat



5907451663714



8 kg

PROMO 4

NEW STRONG TOP



Produkt dostępny również z półką.

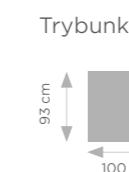

Trybunka

Blat



5907451669112



10 kg

TRYBUNKI PRESTON

- ciężka, solidna i stabilna konstrukcja
- wysoka jakość wykonania
- grafika montowana za pomocą taśmy silikonowej
- dzięki zastosowaniu tkaniny, jako nośnika grafiki, trybunkę można podświetlić od wewnątrz

Zestawy zawierają: trybunkę Preston i torbę transportową typu Canvas.

- heavy, very solid and stable construction
- high quality and very impressive
- graphics mount using a silicone band
- thanks to the use of fabric as a graphic carrier, this counter can be illuminated from inside

These sets include: Preston counter and a transport bag.

Rekomendowana technologia druku:

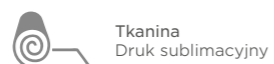

PRESTON OWAL



PRESTON TRÓJKĄT



5907451661512

8 kg

Trybunka Blat



5907451661529

10 kg

Trybunka Blat



PRESTON „NERKA”



5907451663776

8 kg

Trybunka



Blat

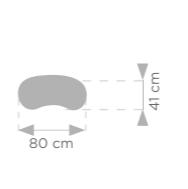

PRESTON PROSTOKĄT



5907451661536

9 kg

Trybunka

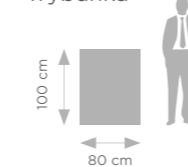

Blat

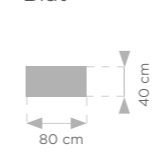

PRESTON XXL



5907451661543

27 kg

Trybunka

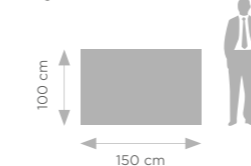

Blat

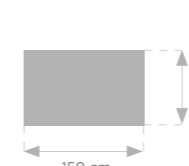

VELCRO POP-UP

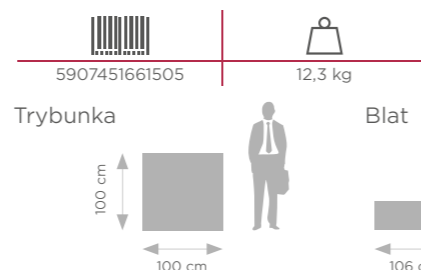

- doskonałe uzupełnienie ścianki Velcro
- grafika montowana na rzepach
- w zestawie praktyczna półka

Zestaw zawiera: trybunkę Velcro Pop-up, torbę transportową Canvas.

- great complement to POP-UP Velcro wall
- graphics mounted with Velcro tape
- ultralight, useful, practical shelf in set

These sets include: Pop-up Velcro counter, Canvas bag.

Rekomendowana technologia druku: Tkanina Druk sublimacyjny

POP-UP 2x1

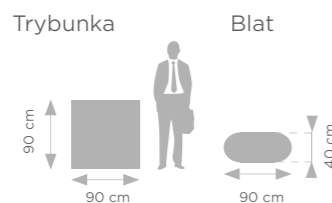

- stelaż typu POP-UP - błyskawiczne rozłożenie systemu
- grafika montowana na brytach PCV
- lekka konstrukcja i atrakcyjny wygląd

Zestawy zawierają: trybunkę Pop-up, torbę transportową typu Canvas.

Rekomendowana technologia druku: Folia Solvent, UV, Latex

POP UP 2x2

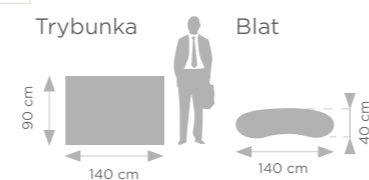

- POP-UP construction
- graphics mounted on PVC boards
- attractive appearance

These sets includes: Pop-up counter, Canvas bag.

PROMO 2 PLUS

- system złożony z drewnianego blatu i podstawy, które łączy bryt PCV montowany za pomocą rzepu
- praktyczny topper

Zestaw zawiera: blat, podstawę i topper zapakowane w torbę transportową, bryt PVC zapakowany w osobną tubę transportową.

- the walls of this system are made of cellular PVC, mounted to the wooden tabletop and wooden base with velcro straps
- practical topper

This set includes: counter top, base and topper packed in transport bag, PVC panel packed in separate transport tube.

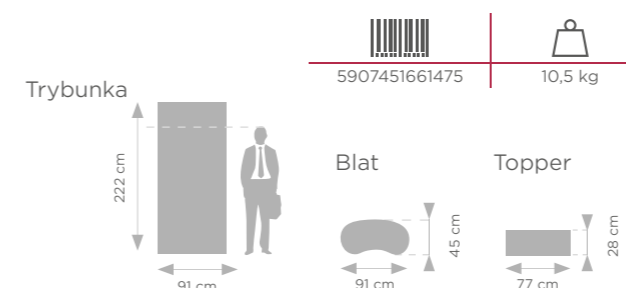

Rekomendowana technologia druku: Folia Solvent, UV, Latex

Produkt dostępny również z półką.

TOPPER

- trybunka wykonana w całości z płyty PCV
- bardzo lekka, a zarazem stabilna konstrukcja
- idealnie rozwiązanie jako narzędzie podczas promocji w supermarketach

Zestaw zawiera: trybunkę Topper oraz torbę transportową.

- counter made entirely of PVC board
- ultralight and stable construction
- perfect as a tool during supermarket promotions

This set includes: Topper counter and a carrying bag.

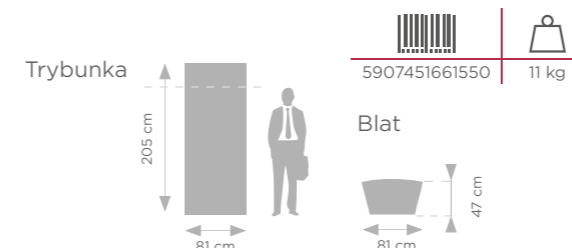

Rekomendowana technologia druku: Folia Solvent, UV, Latex

TRYBUNKI PRESTON AUTOMATIC

- automatyczny, bardzo szybki system rozkładania
- stabilna podstawa i spory blat
- grafika montowana za pomocą taśmy silikonowej
- idealne na stoiska targowe lub promocyjne

- automatic and very quick assembly
- stable base and sizable top
- perfect choice for fair and promoting purposes

Zestawy zawierają: trybunkę Preston i torbę transportową typu Canvas.

These sets include: Preston counter and a transport bag.

Rekomendowana technologia druku: Tkanina Druk sublimacyjny

PRESTON AUTOMATIC OWAL



Trybunka Blat



PRESTON AUTOMATIC PROSTOKĄT

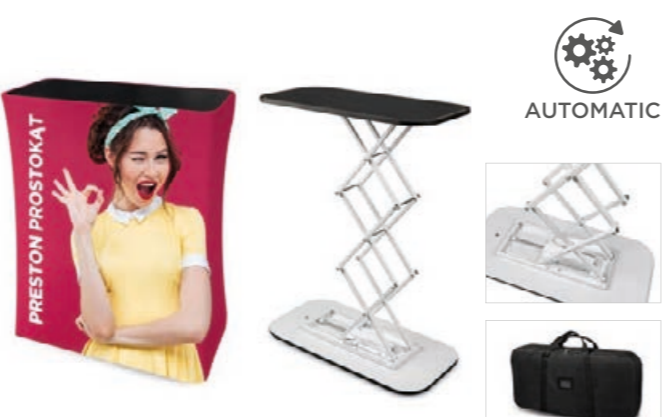

Trybunka Blat

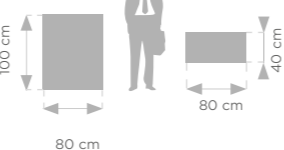

PRESTON AUTOMATIC LED OWAL



Trybunka Blat



PRESTON AUTOMATIC LED PROSTOKĄT



Trybunka Blat

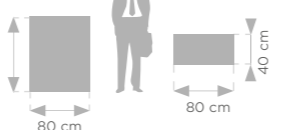

TRYBUNKA LUMIX™

NEW!

PREMIUM LINE

- dwustronny system
- szeroki profil aluminiowy (12 cm)
- zintegrowane oświetlenie LED
- montaż bez narzędzi
- wydruk na tkaninie montowanej na taśmie silikonowej
- torba na kółkach

Zestaw zawiera: trybunkę LUMIX, zasilacz, torbę na kółkach.

- double-sided system
- wide aluminium profile (12 cm)
- integrated LED lighting
- no tools assembly
- silicon tape mounted printout
- wheeled transport bag

The set includes: LUMIX counter, power adapter, wheeled bag.



Rekomendowana technologia druku:

Tkanina Druk sublimacyjny



Trybunka

Blat



TRYBUNKA LED BOX™

- dwustronny system z lampkami LED
 - solidne aluminium (8 cm)
 - montaż bez narzędzi
 - grafika montowana za pomocą taśmy silikonowej
- Zestaw zawiera: trybunkę LED BOX, zasilacz, torbę transportową.

- double-sided LED system
- durable aluminium frame (8 cm)
- no tools assembly
- silicon tape mounted printout

The set includes: LED BOX counter, power adapter, transport bag.



Rekomendowana technologia druku:

Tkanina Druk sublimacyjny



Trybunka

Blat



STOJAKI NA ULOTKI

MONTANA SREBRNA



Produkt dostępny w wersji z torbą lub walizką.

A4	5907451660553	5,2 kg
A3	5907451669365	7,5 kg

MONTANA CZARNA



- dwustronny dostęp do prezentowanych materiałów
- dla katalogów w formacie A4 i A3
- niewielkie rozmiary po złożeniu
- stojak wykonany z aluminium i metalu

- two-sided access to presented materials
- designed for brochures in A4 and A3 format
- small dimension after folding
- made of aluminium and metal

A4	5907451668962	5,2 kg
A3	5907451668955	7,5 kg

BOSTON

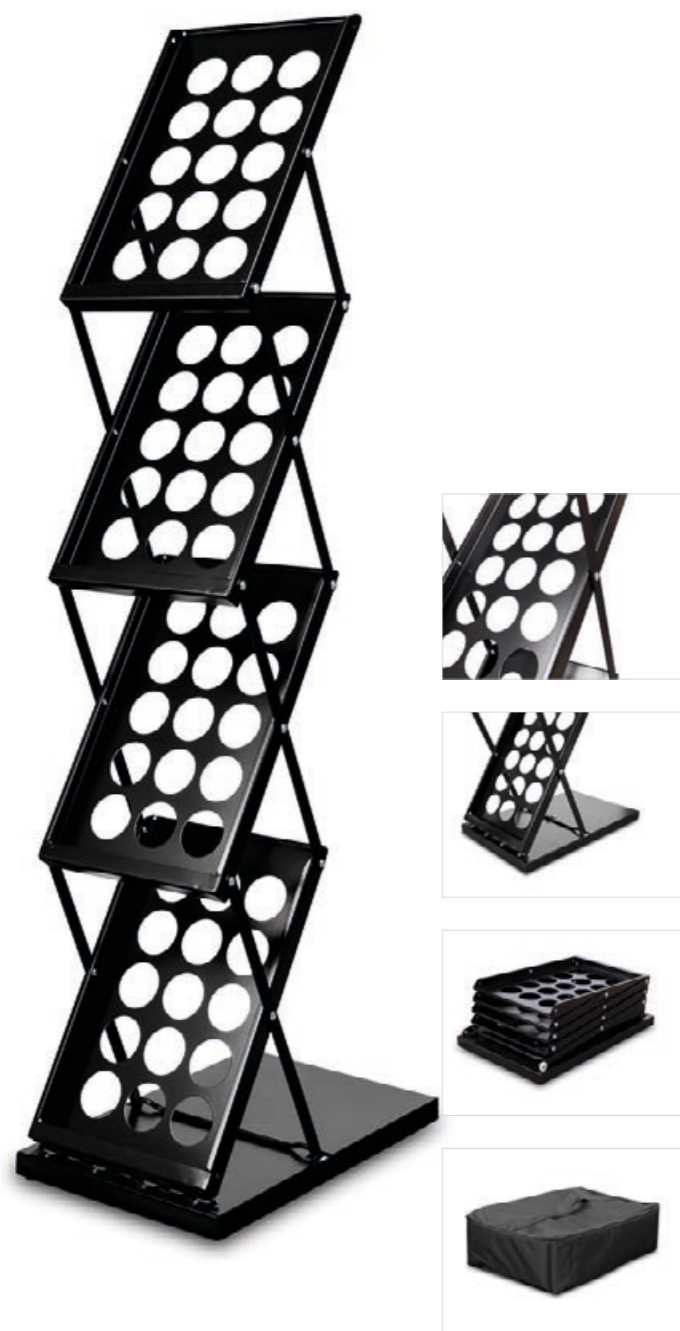

- bestseller
 - wykonany z metalu malowanego proszkowo na kolor czarny
 - niewielkie rozmiary i lekka konstrukcja
- bestseller
 - made entirely of metal, powder coated black
 - small dimension, lightweight frame



A4 5907451660546 4,3 kg

ATLANTA



- solidna metalowa konstrukcja
 - dwustronny dostęp do prezentowanych materiałów
 - niewielkie rozmiary po złożeniu
- solid metal construction
 - two-sided access to presented materials
 - small size after folding



A4 5907451669051 6,6 kg

COLUMBIA



- kieszenie wykonane z grubej, przezroczystej pleksi
 - chromowana podstawa
 - uchwyt, który ułatwia przenoszenie
 - poręczny plecak w komplecie
- pockets made of thick transparent plexiglass board
 - chromed base
 - a grip making it easy to handle
 - handy backpack included



A4 5907451660560 5 kg

LINCOLN



- wyjątkowo trwała i mocna konstrukcja
 - w całości wykonany z metalu malowanego proszkowo na kolor szary i czarny
 - przeznaczony na ulotki w formacie A4
 - torba w komplecie
- extremely durable and strong stand
 - made of metal, powder coated gray and black
 - designed for catalogs and brochures in A4 format
 - bag included



A4 5907451662489 6,5 kg

TRYBUNKA DALLAS



- 2w1 - trybunka i stojak na ulotki
- dostosowany do katalogów w formacie A4 i A3
- stabilna konstrukcja

- 2in1 - counter and brochure holder
- catalogs in A4 and A3 format will fit here
- stable construction



5907451663592 10 kg

TRYBUNKA CONCORD



- 2w1 - trybunka i stojak na ulotki
- dostosowany do katalogów w formacie A4
- elegancki blat wykonany z drewna
- konstrukcja składa się w niewielkie wymiary i mieści w walizce aluminiowej dołączonej do zestawu

- 2in1 - counter and brochure holder
- catalogs in A4 format will fit here
- elegant table top made of light wood
- counter folds into small dimensions and fits in a durable, elegant aluminum case



A4 5907451660577 8 kg

VIRGINIA

- 2w1 - stojak info + stojak na ulotki
- kieszon A4 lub kieszon do formatów uniwersalnych
- ramka OWZ - wydrukuj własny plakat
- bardzo solidna i ciężka konstrukcja

- 2in1 - info stand and brochure holder in one
- A4 or universal pocket
- snap frame for customized poster
- very stable and strong system

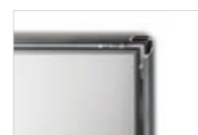

5907451664889 9 kg



LISTWY PLAKATOWE



- duży wybór szerokości - możliwość wykonania listew pod wymiar klienta
 - możliwość montażu do ściany lub sufitu
 - system „Express Clip” - błyskawiczny i prosty montaż i wymiana grafiki
 - elegancki wygląd
 - gruby profil wykonany z aluminium anodowanego
- Zestaw zawiera: listwę górną z zawieszkami i listwę dolną.

- wide choice of sizes - custom sizes available on request
 - possibility of mounting to a wall or ceiling
 - “Express Clip” system - quick and simple assembly and graphics exchange
 - thick profile made of anodized aluminum
- This set includes: top rail with hooks and bottom rail.

Rekomendowana technologia druku:



Stoplight
Solvent, UV, Latex



Baner powlekany
Solvent, UV, Latex



Tkanina
Druk sublimacyjny



Papier
Solvent, UV, Latex

STANDARD

40 cm	5907451662038	0,20 kg
60 cm	5907451661635	0,30 kg
85 cm	5907451660249	0,40 kg
100 cm	5907451660256	0,45 kg
120 cm	5907451660263	0,55 kg
150 cm	5907451660270	0,70 kg
200 cm	5907451660287	0,90 kg



SLIM

40 cm	5907451662045	0,20 kg
60 cm	5907451662052	0,30 kg
85 cm	5907451662069	0,40 kg
100 cm	5907451662076	0,45 kg
120 cm	5907451662083	0,55 kg
150 cm	5907451662090	0,70 kg
200 cm	5907451663707	0,90 kg



CLIP

40 cm	5907451662526	0,20 kg
60 cm	5907451662533	0,30 kg
85 cm	5907451662540	0,40 kg
100 cm	5907451662496	0,45 kg
120 cm	5907451662502	0,55 kg
150 cm	5907451662519	0,70 kg



TWIN

40 cm	5907451662236	0,20 kg
60 cm	5907451662243	0,30 kg
85 cm	5907451662250	0,40 kg
100 cm	5907451662267	0,45 kg
120 cm	5907451662274	0,55 kg
150 cm	5907451662281	0,70 kg



RAMKI OWZ PODWIESZANE VERTICO



- **ramka aluminiowa o szerokim profilu: 32 cm**
- możliwość podwieszenia pod sufitem
- prosty i elegancki design
- system „clip-clap”- błyskawiczny i prosty montaż oraz wymiana plakatu
- **doublesided aluminium frame: 32 mm**
- mounted on the ceiling
- simple and elegant design
- “clip-clap” system - quick and simple graphics assembly and exchange

Rekomendowana technologia druku: Papier Solvent, UV, Latex

A2	5907451665688	2,1 kg
A1	5907451665671	3,4 kg
B2	5907451665701	2,7 kg
B1	5907451665695	4,3 kg



RAMKI OWZ STANDARD

- **profil aluminiowy: 25 mm**
- osłona na plakat z filtem UV
- system „clip-clap” - błyskawiczny i prosty montaż oraz wymiana grafiki
- możliwy montaż pionowy lub poziomy
- **aluminium profile: 25 mm**
- poster cover with UV-filter protects the printout from fading graphic colours
- “clip-clap” system - quick and simple assembly and graphics exchange
- vertical or horizontal assembly

Rekomendowana technologia druku: Papier Solvent, UV, Latex

RAMKI OWZ SREBRNE



A5	5907451662557	0,30 kg
A4	5907451661567	0,45 kg
A3	5907451661574	0,65 kg
A2	5907451661581	1,15 kg
A1	5907451661598	1,90 kg
A0	5907451661604	3,60 kg
B3	5907451662564	0,95 kg
B2	5907451661628	2,00 kg
B1	5907451661611	2,60 kg

RAMKI OWZ CZARNE

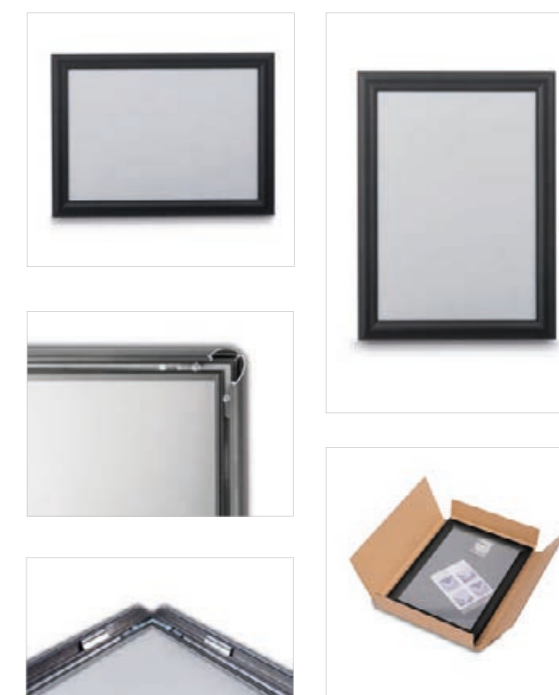

A4	5907451664872	0,45 kg
A3	5907451664865	0,65 kg
A2	5907451664858	1,15 kg
A1	5907451664841	1,90 kg
B3	5907451665787	0,95 kg
B2	5907451665794	2 kg
B1	5907451665800	2,6 kg

RAMKI OWZ PREMIUM



- szeroki profil aluminiowy: 32 mm
- system „clip-clap” – błyskawiczny i prosty montaż oraz wymiana grafiki
- możliwy montaż pionowy lub poziomy
- osłona na plakat z filtrem UV
- aluminium profile: 32 mm
- “clip-clap” system – quick and simple assembly and graphics exchange
- vertical or horizontal assembly
- poster cover with UV-filter protects the printout from fading graphic colours



A3	5907451664230	1,20 kg
A2	5907451664223	1,85 kg
A1	5907451664216	2,80 kg

Rekomendowana technologia druku: Papier Solvent, UV, Latex

RAMKI MAGNETIC

MAGNETIC

- prosty i elegancki design
- błyszcząca folia antyrefleksyjna przytrzymuje wydruk przy pomocy zamontowanych do niej i do ramki pasków magnetycznych
- montaż bez narzędzi
- dobry stosunek jakości do ceny
- simple and elegant design
- glossy anti-reflective Folia holds the printout with magnetic strips
- assembly without tools
- value for money

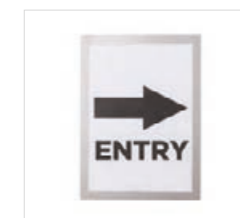

A5 (srebrny)	6956526031285
A4 (srebrny)	6956526031278
A3 (srebrny)	6956526031261
A4 (czarny)	5907451663424
A3 (czarny)	5907451662670

MAGNETIC REWERS

- ramka przyklejana przodem
- prosty i elegancki wygląd
- dwustronna
- montaż bez narzędzi
- front-glued frame
- double-sided
- simple and elegant design
- assembly without tools



A4 (srebrny)	6956526031513
A3 (srebrny)	6956526031520
40x60 cm (srebrny)	6956526031537
A4 (czarny)	5907451665015



MAGNETIC BHP

- ramka magnetyczna w wersji ostrzegawczej niezbędna w halach produkcyjnych, magazynach, parkingach i miejscach objętych szczególnym nadzorem
- błyszcząca folia antyrefleksyjna przytrzymuje wydruk przy pomocy zamontowanych do niej i do ramki pasków magnetycznych
- montaż bez narzędzi
- magnetic frame in warning version
- necessary in production halls, warehouses, parking lots and places under special supervision
- simple and elegant design
- glossy anti-reflective Folia holds the printout with magnetic strips
- assembly without tools



A4	5907451663486
A3	5907451663479

Rekomendowana technologia druku: Papier Solvent, UV, Latex

TABLICZKI PRZYDRZWIOWE

SONIC

- jedno z najpopularniejszych tabliczek przydrzwiowych na rynku
- szybki montaż
- system „clip-clap” – wymiana wizytówki zabiera kilka sekund
- montaż przy pomocy śrub lub taśmy dwustronnej
- w komplecie folia antyrefleksyjna
- dobry stosunek jakości do ceny

- one of the most popular wall door signs on the market
- quick assembly
- popular “clip-clap” system – graphics change takes few seconds
- anti-reflective film included
- mounting with fixing bolts or double-sided tape
- value for money

Rekomendowana technologia druku:



A6	6956526031179
A5	6956526031162
A4	6956526031155

ELITE

- wyjątkowo elegancki wygląd
- najczęściej wybierany do wnętrz nowoczesnych
- wymiana treści poprzez odkręcenie dystansów przytrzymujących dwie płytki pleksi
- tabliczka sugerowana do rozwiązań niewymagających częstej wymiany grafiki

- very elegant look
- most frequently chosen for modern style interiors
- graphic may be replaced by unscrewing two stand-offs holding two plexiglass sheets
- use this system if you don't need to change the graphics frequently

A6	6956526032121
148x148 mm	6956526032138
A5	6956526032145
A4	6956526032169

Rekomendowana technologia druku:



GERT

- nowoczesny wygląd
- klasyczny popielaty kolor pasujący do wszystkich wnętrz
- wymiana treści poprzez otwarcie zatrzasków tabliczki, jednym ruchem
- brak konieczności posiadania jakichkolwiek narzędzi

- modern design
- classic ash-grey color which fits any interior design
- graphics may be replaced with a single move, just by opening the plate clips
- no tools required

Rekomendowana technologia druku:



149x64 mm	6956526032084
149x105,5 mm	6956526032091
149x148,5 mm	6956526032107



PURO

- nowoczesny wygląd
- łatwa wymiana treści
- tabliczka z grubego profilu aluminiowego
- montaż przy pomocy taśmy dwustronnej

- modern look
- easy content exchange
- made of a very thick aluminium profile
- mounting with double-sided tape

180x50 mm	6956526031711
180x70 mm	6956526031728
210x90 mm	6956526031735

Rekomendowana technologia druku:



MANTA

- minimalistyczny wygląd
- sprawdzi się szczególnie we wnętrzach o skandynawskim, jasnym stylu
- tabliczka posiada białą ramkę na którą nakłada się (przy pomocy zatrzasków) przednią szybkę pleksi

- minimalistic look
- suitable for interiors designed in bright – Scandinavian style
- this holder is equipped with a white frame on which front plexiglass pane is installed (with clips)

A6	6956526050989
A5	6956526050996
A4	6956526051009

Rekomendowana technologia druku:



STOJAKI AKRYLOWE CRYSTAL

- dwustronny stojak akrylowy
 - idealnie sprawdzi się do postawienia na stole / ladzie we wnętrzach różnych przestrzeni publicznych np. w restauracjach, bankach, hotelach
 - szeroka podstawa gwarantuje stabilność
 - uniwersalny wygląd
- double sided acrylic stand
 - ideal for placing on a table / counter in various public spaces, e.g. restaurants, banks, hotels
 - wide base ensures stability
 - versatile appearance

Rekomendowana technologia druku:



Papier
Solvent, UV, Latex

A7	6956526050132
A6	6956526050156
A5	6956526050163
A4	6956526050170



VISTA POZIOMA

- masywny, akrylowy stojak z szeroką podstawą
 - wyjątkowo elegancki wygląd
 - prezentacja treści w pozycji poziomej
 - dwustronny
- heavy acrylic stand with a broad base
 - elegant look
 - horizontal graphic presentation
 - double-sided

A6	6956526053775
A5	6956526053768
A4	6956526053751

Rekomendowana
technologia druku:



Papier
Solvent, UV, Latex



PLATINUM

- stojak akrylowy o lekkim kącie nachylenia
 - minimalistyczny wygląd
 - idealnie sprawdzi się do postawienia na stole / ladzie we wnętrzach różnych przestrzeni publicznych np. w bankach, hotelach, recepcjach firm itp.
 - szeroka podstawa o ciekawym designie gwarantuje stabilność
- acrylic stand with a slight angle of inclination
 - minimalistic look
 - ideal for placing on a table / counter in the interiors of various public spaces, e.g. in banks, hotels, corporate receptions, etc.
 - wide base with interesting design guarantees stability

Rekomendowana technologia druku:



Papier
Solvent, UV, Latex

A5	6956526053638
A4	6956526053645



VISTA PIONOWA

- masywny, akrylowy stojak z szeroką podstawą
 - wyjątkowo elegancki wygląd
 - prezentacja treści w pozycji pionowej
 - dwustronny
- heavy acrylic stand with a broad base
 - elegant look
 - vertical graphic presentation
 - double-sided

A6	6956526053737
A5	6956526053720
A4	6956526053713

Rekomendowana
technologia druku:



Papier
Solvent, UV, Latex



SYSTEMY LINKOWE

- populärer System ROD für das Aufhängen von Werbetafeln
- hohe Qualität Aluminium
- minimalistischer und eleganter Look
- im Set eine lange Stahlfeder (300 cm/400 cm)
- regulierbare Stahlfederlänge
- im Komplettsatz Winkelstücke und Schrauben zum Einbau

- popular ROD system for wall to wall hanging adv boards
- made from high quality aluminium
- minimalistic and elegant appearance
- long steel rope (300 cm/400 cm) included
- adjustable steel rope length
- anchors and screws for mounting included

SYSTEM ŚCIANA-ŚCIANA



300 cm



		ROD
5907451664490	0,5 kg	300 cm

SYSTEM ŚCIANA-PODŁOGA/SUFIT



400 cm



		ROD
5907451664513	0,4 kg	400 cm

SYSTEM SUFIT-PODŁOGA

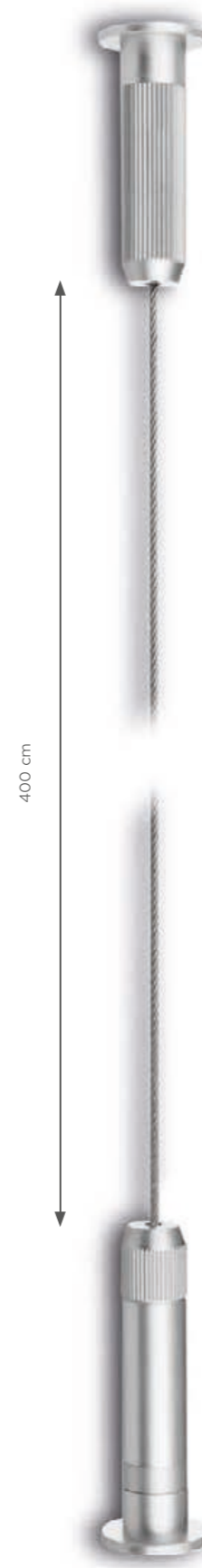

400 cm



		ROD
5907451664506	0,3 kg	400 cm

SYSTEM SUFIT-TABLICA

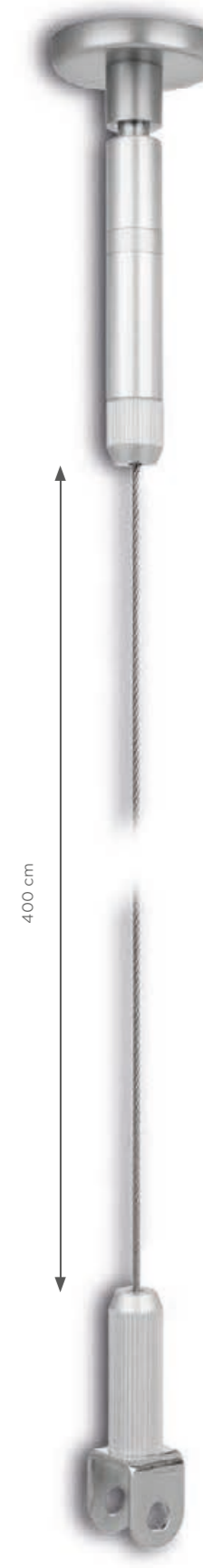

400 cm



		ROD
5907451664520	0,4 kg	400 cm

AKCESORIA



JEDNOSTRONNE MOCOWANIE TABLICY



5907451664537 0,1 kg

DWUSTRONNE MOCOWANIE TABLICY



5907451664544 0,15 kg

DYSTANSE

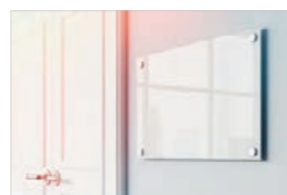

- przeznaczone do montażu wszystkich rodzajów tablic reklamowych
- wykonane z aluminium
- wysoka jakość
- wiele rozmiarów

- designed for mounting all types of advertising boards
- made of aluminum
- high quality
- multiple sizes

SREBRNA SATYNA



Barcode	
13x13 mm	5907451664551
13x19 mm	5907451664575
15x20 mm	5907451664599
15x25 mm	5907451664612
19x19 mm	5907451664636
19x25 mm	5907451664650
25x29 mm	5907451664674
25x25 mm	5907451664698

SREBRNY MAT



Barcode	
13x13 mm	5907451668108
13x19 mm	5907451668115
15x20 mm	5907451668122
15x25 mm	5907451668139
19x19 mm	5907451668146
19x25 mm	5907451668153
25x19 mm	5907451668160
25x25 mm	5907451668177

CZARNY MAT



Barcode	
13x13 mm	5907451664568
13x19 mm	5907451664582
15x20 mm	5907451664605
15x25 mm	5907451664629
19x19 mm	5907451664643
19x25 mm	5907451664667
25x19 mm	5907451664681
25x25 mm	5907451664704

POTYKACZE

AURORA

- profil aluminiowy: 25 mm
 - dwustronna prezentacja grafiki
 - wysoka wytrzymałość na warunki atmosferyczne
 - system „clip-clap” – błyskawiczna wymiana grafik
 - osłona na plakat z filtrem UV
- Zestaw zawiera: potykacz Aurora, indywidualny karton.

- aluminium profile: 25 mm
 - double-sided
 - very resistant to weather conditions
 - clip-clap system – quick graphics exchange
 - poster cover with UV-filter protects the printout from fading colours
- The set includes: stand Aurora in a carton box.

Rekomendowana technologia druku:



AURORA SREBRNA



A2	5907451662021	6,75 kg
A1	5907451662151	9,00 kg
A0	5907451662144	12,60 kg
B2	5907451662182	5,00 kg
B1	5907451662175	9,20 kg

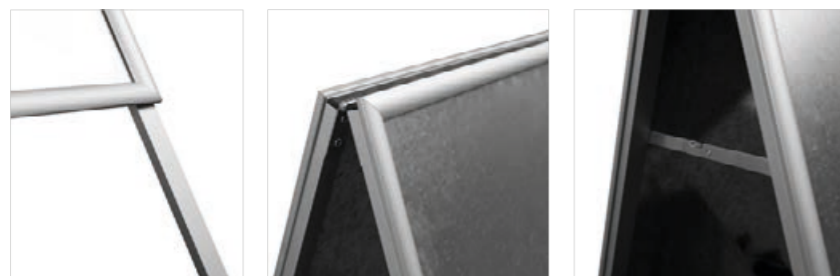

AURORA CZARNA

A2	5907451664384	6,75 kg
A1	5907451664377	9,00 kg

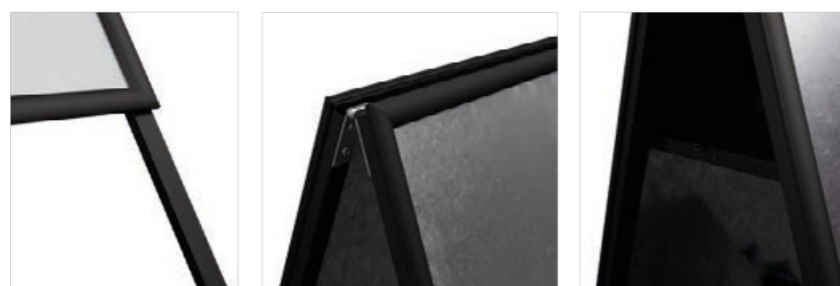

SPIDER



- profil aluminiowy: 32 mm
- wyjątkowo stabilny nawet przy silnym wietrze
- dwustronna prezentacja grafiki
- bardzo odporny na warunki atmosferyczne
- system „clip-clap” – błyskawiczna wymiana grafik
- osłona na plakat z filtrem UV

Zestaw zawiera: potykacz Spider, indywidualny karton.

- aluminium profile: 32 mm
- extremely stable even in strong winds
- double sided
- very weather resistant
- clip-clap system - quick graphics exchange
- poster cover with UV-filter protects the printout from fading colours

This set includes: stand Spider in individual box.



A1	5907451662205	8,8 kg

Rekomendowana technologia druku:



HAMPTON

- profil aluminiowy: 32 mm
 - podstawa może być wypełniona wodą lub piaskiem
 - wyjątkowo stabilny nawet przy silnym wietrze
 - bardzo odporny na opady
 - dwustronna prezentacja grafiki
 - system clip-clap – szybka wymiana grafiki
 - osłona na plakat z filtrem UV
- Zestaw zawiera: potykacz Hampton, indywidualny karton.

- aluminium profile: 32 mm
 - base can be filled with water or sand
 - extremely stable even in strong wind
 - double sided
 - very weather resistant
 - clip-clap system – quick graphics exchange
 - poster cover with UV-filter protects the printout from fading colours
- This set includes: stand Hampton in a carton box.

Rekomendowana technologia druku: Papier Solvent, UV, Latex

HAMPTON SREBRNY



A1	5907451662014	15 kg
A0	5907451663554	22 kg
B2	5907451663325	18 kg
B1	5907451663561	13 kg



HAMPTON CZARNY



A1	5907451662199	15 kg
B2	5907451665756	13 kg



HAMPTON PRO

NEW!

- profil aluminiowy: 40 mm
 - zwiększona wytrzymałość na warunki atmosferyczne
 - podstawa może być wypełniona wodą lub piaskiem
 - wyjątkowo stabilny nawet przy silnym wietrze
 - specjalna rączka i kółka ułatwiają przemieszczanie systemu
 - dwustronna prezentacja grafiki
 - system clip-clap – szybka wymiana grafiki
 - osłona na plakat z filtrem UV
- Zestaw zawiera: potykacz Hampton, indywidualny karton.

- aluminium profile: 40 mm
 - enhanced water resistance parameters
 - base can be filled with water or sand
 - handle and wheels for easy transport
 - extremely stable even in strong wind
 - double sided
 - clip-clap system – quick graphics exchange
 - thick poster cover with UV-filter protects the printout from fading colours
- The set includes: stand Hampton Pro in a carton box.

Rekomendowana technologia druku: Papier Solvent, UV, Latex

ZWIĘKSZONA
ODPORNOŚĆ
NA WARUNKI
ATMOSFERYCZNE

WYTRZYMAŁOŚĆ
NA WIATR

SZYBKA
WYMIANA
GRAFIKI
(RAMKA OWZ)

OSŁONA
NA PLAKAT
Z FILTREM UV

DWUSTRONNY
SYSTEM

HAMPTON PRO SREBRNY



A1	5907451666784	17 kg



HAMPTON PRO CZARNY



A1	5907451666791	17 kg



INFO STAND CHROMA



- profil aluminiowy: 25 mm
 - dwustronny stojak plakatowy
 - idealnie sprawdzi się w różnych przestrzeniach publicznych
 - łatwy montaż grafiki poprzez wsunięcie jej w ramkę
 - stabilna konstrukcja
- Zestaw zawiera: Info stojak Chroma w indywidualnym kartonie.

- aluminium profile: 25 mm
 - double sided poster stand
 - ideal for use in various public spaces
 - easy installation of graphics via a sliding panel
 - stable construction
- This set includes: Info stand Chroma in individual box.



INFO/MENU STAND PULADI



- regulowany kąt nachylenia ramy
 - przezroczysta ramka
 - stabilna, stalowa podstawa
 - wymiana grafiki poprzez wsunięcie jej w akrylową ramę
 - niewielkie rozmiary po złożeniu
 - produkt przeznaczony m. in do wskazywania kierunków oraz prezentacji informacji
- Zestaw zawiera: stojak Puladi, zestaw montażowy z imbussem, indywidualny karton..

- adjustable angle, transparent frame
 - stable steel base
 - exchange of graphics by sliding it into an acrylic frame
 - compact size when folded
 - product intended for directions and presenting information
- The set includes: Puladi stand, assembly kit with a hex key, individual box.

A4	6956526030080	2,2 kg	114 cm
A3	6956526030127	3,3 kg	120 cm

Rekomendowana technologia druku:

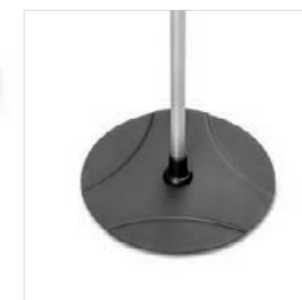

5907451664414 | 5,50 kg

INFO/MENU STAND CLASSIC

ramka z aluminium: 25 mm

- stabilna podstawa wykonana ze stali
- regulowany kąt nachylenia ramy
- błyskawiczna wymiana grafiki na zasadzie ramki zatrzaskowej OWZ
- niewielkie rozmiary po złożeniu

Zestaw zawiera: stojak Classic, zestaw montażowy z imbussem, indywidualny karton.

aluminium profile: 25 mm

- base made of steel - very stable
- adjustable frame angle
- clip-clap system - quick graphics exchange
- compact size when folded

The set includes: stand Classic, assembly kit with a hex key, individual box.



Rekomendowana technologia druku:



A4	6956526030257	2,4 kg	111 cm
A3	6956526030264	3,5 kg	115 cm

INFO/MENU STAND PREMIUM

aluminiowa ramka: 25 mm

- stabilna, żeliwna podstawa
- bardzo elegancki stojak informacyjny
- system przeznaczony m. in. do menu restauracyjnego, prezentacji tabliczek informacyjnych itp.
- wymiana grafiki na zasadzie ramki zatrzaskowej OWZ
- możliwość ustawienia ramki w pionie lub poziomo

Zestaw zawiera: stojak Info/Menu Premium, indywidualny karton.

aluminium profile: 25 mm

- base made of iron
- very elegant info stand
- designed, among others for restaurant menu, directions, presentation of information boards etc.
- clip-clap system - quick graphics exchange
- the frame can be positioned vertically or horizontally

This set includes: stand Premium stand in a carton box.

Rekomendowana technologia druku:



PREMIUM SREBRNY



PREMIUM CZARNY



INFO/MENU STAND STANDARD

ramka aluminiowa: 25 mm

- stabilna, żeliwna podstawa
- bardzo elegancki stojak informacyjny przeznaczony m.in. do menu restauracyjnego, prezentacji tabliczek informacyjnych itp.
- wymiana grafiki na zasadzie ramki zatrzaskowej OWZ
- możliwość ustawienia ramki w pionie lub poziomo

Zestaw zawiera: stojak Info/menu Standard, indywidualny karton.

aluminum profile: 25 mm

- very elegant info stand
- designed, among others for restaurant menu, directions, presentation of information boards etc.
- clip-clap system - quick graphics exchange
- the frame can be positioned vertically or horizontally
- base made of iron

This set includes: stand Standard in a carton box.



Rekomendowana technologia druku:



A4	5907451662106	3,70 kg	116 cm
A3	5907451664322	4,30 kg	121 cm

A3	5907451664407	4,70 kg	126 cm
A2	5907451664391	5,00 kg	140 cm

A4	5907451667590	4 kg	125 cm
A3	5907451664438	4,70 kg	126 cm
A2	5907451664421	5,00 kg	140 cm

SZTALUGA METALOWA



- sztaluga z metalu pomalowanego proszkowo
 - niewielkie rozmiary po złożeniu
 - elegancka torba w zestawie
- Zestaw zawiera: sztalugę, torbę transportową.

- made of black powder painted metal
 - small size after folding
 - elegant case included
- The set includes: easel, transport case.



5907451663578



1,2 kg



PRODUKTY DREWNIANE

POTYKACZ CLASSIC

- profil: 35 mm
- elegancka, drewniana rama
- powierzchnia do pisania - tablica kredowa
- idealne rozwiązanie dla restauracji czy innych powierzchni

- profile: 35 mm
- elegant wooden frame
- versatile design-will fit into any space
- writing surface made of chalkboard
- ideal for restaurants and retail spaces

CLASSIC



S	51x90 cm	5907451669808	3,5 kg
M	60x100 cm	5907451664780	4 kg
L	61x118 cm	5907451669785	5,5 kg
XL	72x160 cm	5907451669778	9 kg

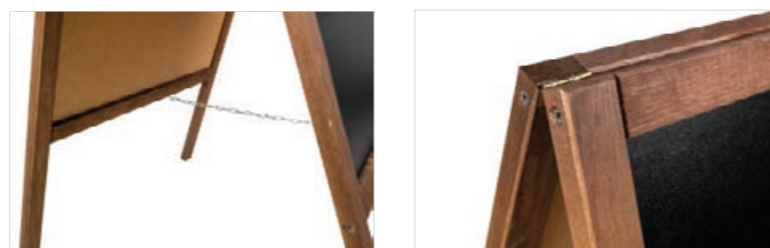

DOSTĘPNE KOLORY:

CLASSIC NATURALNY



S	51x90 cm	5907451667484	3,5 kg
M	60x100 cm	5907451667347	4 kg
L	61x118 cm	5907451668535	5,5 kg
XL	72x160 cm	5907451667491	9 kg



DOSTĘPNE KOLORY:

POTYKACZ PRO WODOODPORNY

- profil: 60 mm
- wytrzymałość na warunki atmosferyczne dzięki lakierowanej powierzchni
- bardzo trwała konstrukcja
- stabilny produkt o wadze 21 kg
- łańcuszek zabezpieczający rozstawienie nóg potykacza

- profile: 60 mm
- weather resistant due to varnish coating
- very durable construction
- stability ensured by the weight - 21 kg
- silver chain securing the legs



L	65x118 cm	5907451669747	21 kg

MARKERY KREDOWE

Zestaw 8 markerów z płynną kredą do pisania na tablicach kredowych. Doskonała alternatywa dla pyłacej, tradycyjnej kredy. W zestawie 8 markerów w „żywych” kolorach: biały, żółty, pomarańczowy, różowy, czerwony, błękitny, fioletowy, zielony. Każdy marker posiada dwustronną końcówkę: okrągłą oraz płaską. Daje to możliwość pisania linią o różnych szerokościach. Markery są bezzapachowe i nietoksyczne oraz łatwo zmywalne przy pomocy wody.



A set of 8 markers with liquid chalk for chalkboard writing. A perfect replacement for dusty chalk. The set consists of 8 markers in following vivid colours: white, yellow, orange, pink, red, light blue, violet, green. The markers have a dual, reversible chisel: round and flat. This enables writing in bold. Markers are non-toxic, unscented, and easily removed with water.



5907451665480

TABLICE KREDOWE

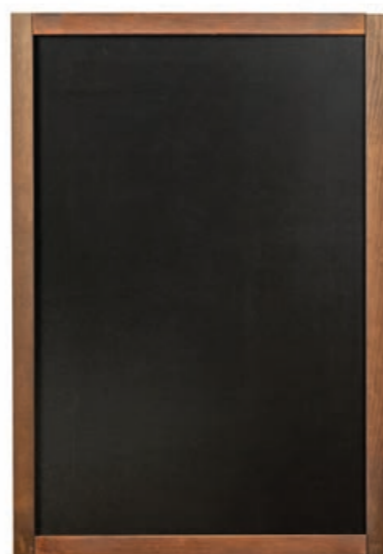

Klasyczne tablice z powierzchnią kredową w drewnianej ramie. **Ramy tablic kredowych mają szerokość 3,5 cm.** Powierzchnia do pisania wykonana jest z twardej i wytrzymałej płyty HDF. Można po niej pisać kredą lub markerem kredowym. Możliwość wieszania w pionie i poziomie lub eksponowania na sztaludze.

Classic chalkboards in wooden frames. **The frame profile is 3,5 cm.** The writing, black space is made of solid, durable HDF board. Chalk and liquid chalk markers can be used for writing on the HDF board. The chalkboards can be presented vertically and horizontally.



wymiary ramy	wymiary tablicy	Barcode	Waga
47×60 cm	40×53 cm	5907451669686	1,5 kg
47×79 cm	40×72 cm	5907451669679	1,8 kg
60×87 cm	53×80 cm	5907451669662	2,1 kg
80×100 cm	73×93 cm	5907451669655	3 kg

STOJAKI KREDOWE



Tabliczki kredowe dwustronne w 3 rozmiarach. Tabliczki mają drewnianą podstawę w kolorze brązowym. Prosty, klasyczny wygląd stojaków pozwala na ich zastosowanie w wielu przestrzeniach. Powierzchnia do pisania została wykonana z trwałej płyty HDF, po której można pisać kredą lub dającymi doskonały efekt markerami kredowymi.

Double sided tabletop chalkboards in 3 sizes. The bottom is a brown wooden panel. Classic, plain look ensures fine presenting the stand in various spaces. The black board is made of durable HDF plate, that makes it possible to write with chalk or liquid chalk markers on it.



	wymiary tablicy	Barcode
A6	10×15 cm	5907451669624
A5	15×21 cm	5907451669631
A4	21×30 cm	5907451669648

SZTALUGI

Drewniana sztaluga sprawdzi się jako elegancki ekspozytor w sklepach, galeriach czy restauracjach. Klasyczny wygląd i stabilna konstrukcja, to cechy tego produktu. Sztaluga posiada regulowany kąt nachylenia. Półka dolna oraz górny uchwyt zapewniają pewne trzymanie ramy lub obrazu.

A wooden easel will be perfect as a display in stores, galleries or restaurants. Classic look and stable construction are the distinctive features of this product. The easel has an adjustable tilt angle. The bottom shelf and upper handle ensure reliable hold of the frame or picture.

SZTALUGA NATURALNA



5907451669716

Tablicę należy dokupić osobno

SZTALUGA MAHOŃ



5907451669143 Tablicę należy dokupić osobno

SZTALUGA BIAŁA



5907451668979 Tablicę należy dokupić osobno

SZTALUGA CZARNA



5907451668986 Tablicę należy dokupić osobno

LEŻAKI

- solidna konstrukcja, drewno sosnowe
- 3 stopnie regulacji oparcia
- wysoka wytrzymałość (do 120 kg)
- specjalne blokady zapobiegają przed przypadkowym złożeniem leżaka

Produkt spełnia normy PN-EN 581-1:2017-04 oraz PN-EN 581 1-2:2016-02.

- sturdy pine construction
- 3-stage backrest adjustment
- high load capacity (120 kg)
- special locking elements prevent the lounger from uncontrolled folding

The product meets PN-EN 581-1:2017-04 oraz PN-EN 581 1-2:2016-02 requirements.

LEŻAK ZŁOŻONY (4 SZT.)

Zestaw zawiera: leżak (4 szt.), wkręty, opakowanie kartonowe zbiorcze.

The set includes: lounger (4 pieces), screws, bulk carton box.



Zestaw nie zawiera materiału siedziska



5907451668788



10 kg

LEŻAK DO SAMODZIELNEGO ZŁOŻENIA

Zestaw zawiera: leżak do samodzielnego montażu (1 szt.), wkręty, blokady (6 szt.) z wkrętami, instrukcja montażu, indywidualny karton.

The set includes: lounger for self-assembly (1 piece), screws, blocking elements (6 pcs) with screws, assembly instructions, an individual carton box.



Zestaw nie zawiera materiału siedziska



5907451668795



2,5 kg

SŁUPKI ODGRADZAJĄCE

SŁUPKI PREMIUM

Wysokiej jakości słupki odgradzające z automatem do zwijania taśmy. Waga słupka została podniesiona do 7,5 kg, a taśma wydłużona do 225 cm. Głowica nawijająca jest zintegrowana ze słupkiem, a jej wymiana jest bardzo prosta i szybka. Taśma zastosowana w głowicy to samochodowy pas bezpieczeństwa, niezwykle mocny i trwały (kolor czerwony - wymienny).

High quality barrier posts with a tape winding system. The post weight was raised to 7.5 kg, and the tape extended to 225 cm. The winding head is integrated with the post, and its replacement is very simple and quick. The tape used in the head is a car seat belt, extremely strong and durable (red colour - exchangeable).

PREMIUM CZARNY



PREMIUM CHROM



PREMIUM BIAŁY



GŁOWICE WYMIENNE DO SŁUPKÓW



SŁUPKI HOTELOWE

Bariera hotelowa znana na wielu rynkach w dwóch najpopularniejszych kolorach: złotym i srebrnym. Niezwykle stabilna, wysoka jakość. Będzie to nie tylko system sterowania ludźmi, ale także dekoracja wnętrz restauracji, klubów czy hoteli.

Hotel barrier well known in many markets in the two most popular colors: gold and silver. Extremely stable, high quality. It will not only be a system to control people, but also an interior decoration for restaurants, clubs or hotels.



ROYAL CHROM

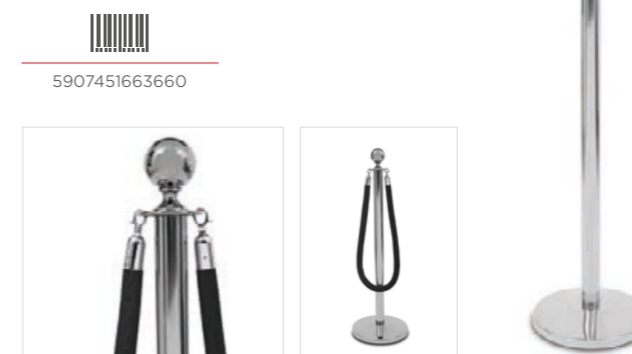

MODERN CHROM

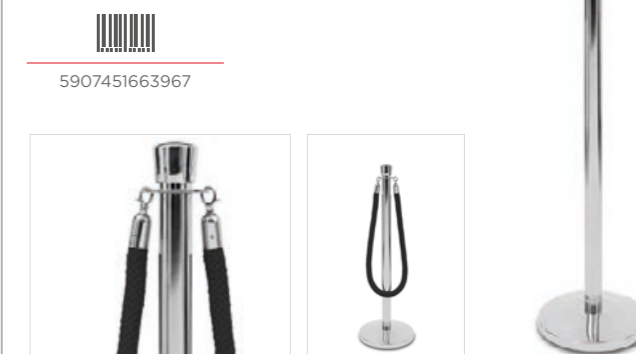

ROYAL ZŁOTY

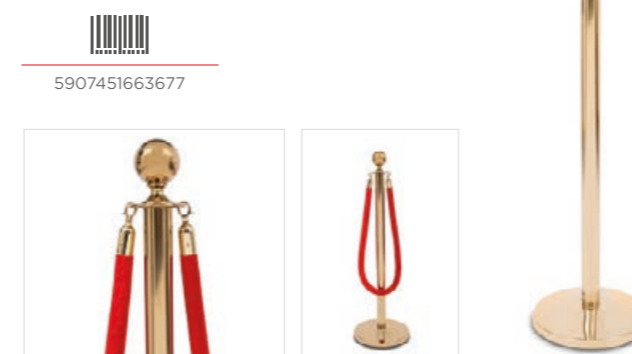

MODERN ZŁOTY

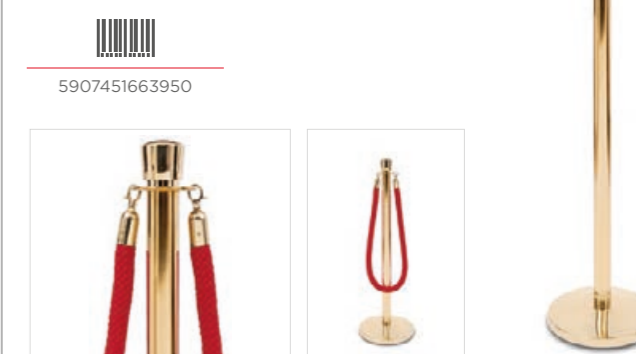

BORDER WELUROWY



BORDER PLECIONY



Bordery dostępne ze srebrnymi lub złotymi klamrami.

RAMKI INFORMACYJNE NA SŁUPKI

 Ramka informacyjna A4 dwustronna, umieszczona na szczycie słupka.

 Double-sided A4 information frame applied on the top of barrier post.

RAMKA CHROM

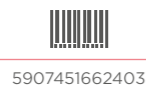

5907451662403

RAMKA CZARNA



5907451662397

GŁOWICA NAŚCIENNA

 Taśmę wymienić można na inne kolory, zakupując głowice zamienną w naszym sklepie.

 A belt in another colour is available by purchasing a replacement head in our store.



czarna 5907451665053

czzerwona 5907451663318



MASZTY FLAGOWE

MASZTY STANDARD

1 maszt = wiele kształtów
Przykładowe kształty:



- jeden maszt = wiele kształtów
- niska cena
- szybki montaż
- aluminium + włókno szklane
- pasuje do wszystkich typów naszych podstaw

Zestaw zawiera: maszt Standard i worek poliestrowy.

- one pole - many shapes
- low cost pole
- quick assembly
- aluminium + fibreglass
- fits to all types of our bases

This set includes: Standard pole and taffeta sack.

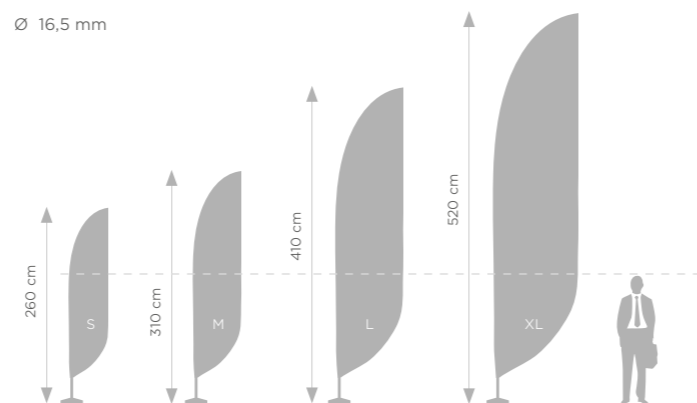

Rekomendowana technologia druku:

Tkanina do flag
Druk sublimacyjny

S	5907451662298	0,40 kg	290 cm
M	5907451662304	0,50 kg	350 cm
L	5907451662311	0,60 kg	450 cm
XL	5907451662328	0,80 kg	550 cm

MASZT PRO

1 maszt = wiele kształtów
Przykładowe kształty:



- jeden maszt = wiele kształtów
- maszt w całości wykonany z włókna szklanego
- wysoka jakość produktu
- szybki montaż
- pasuje do wszystkich typów naszych podstaw

Zestaw zawiera: maszt PRO i worek poliestrowy.

- one pole - many shapes
- mast made entirely of fibreglass
- high quality
- quick assembly
- fits to all types of our bases

This set includes: PRO pole and taffeta sack.

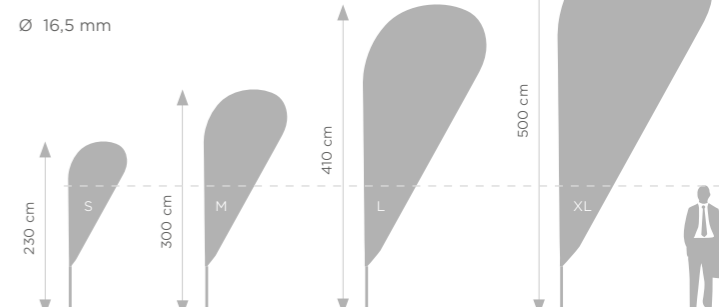

Rekomendowana technologia druku:

Tkanina do flag
Druk sublimacyjny

S	5907451662335	0,50 kg	290 cm
M	5907451662342	0,60 kg	340 cm
L	5907451662359	0,70 kg	450 cm
XL	5907451662366	0,95 kg	560 cm

TWISTER STANDARD

- maszt w całości wykonany z włókna szklanego
- wysoka jakość produktu
- pasuje do wszystkich typów naszych podstaw

Zestaw zawiera: system Twister i torbę.

- full fibreglass
- high quality product
- fits to all kinds of our bases

This set includes: Twister system and a bag.

S	TWI000270	1,50 kg	270 cm
M	TWI000320	1,60 kg	320 cm
L	TWI000430	1,70 kg	430 cm
XL	TWI000540	1,95 kg	540 cm

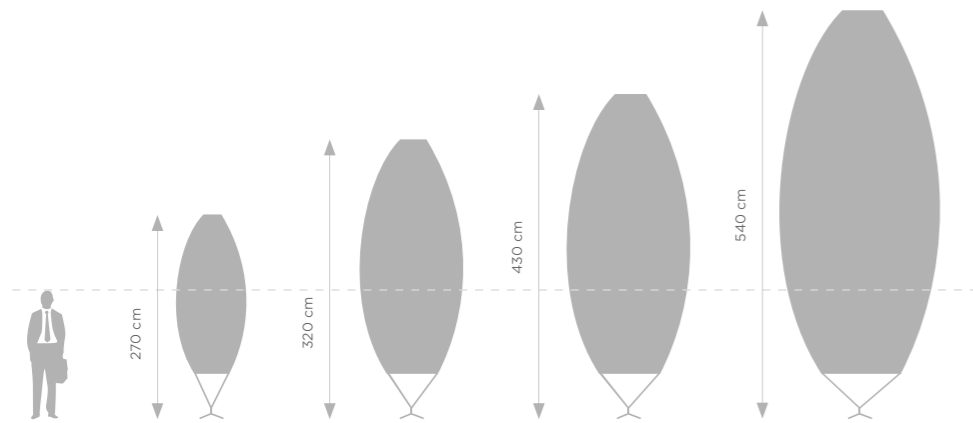

Rekomendowana technologia druku:



Tkanina do flag
Druk sublimacyjny

Ø 16,5 mm



MASZT H

- duża powierzchnia reklamowa
- sprawdzi się nawet przy braku wiatru
- szybki i prosty montaż
- pasuje do wszystkich typów podstaw
- w całości wykonany z aluminium

Zestaw zawiera: maszt H i worek poliestrowy.

- large advertising space
- even in the absence of wind
- quick and easy assembly
- fits to all kinds of our bases
- full aluminium

This set includes: H pole and taffeta sack.

S	5907451663271	0,80 kg
M	5907451662441	0,90 kg
L	5907451663288	1,20 kg

Rekomendowana technologia druku:



Tkanina do flag
Druk sublimacyjny

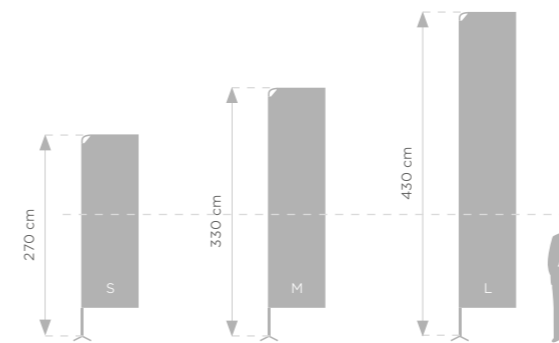

Ø 16,5 mm

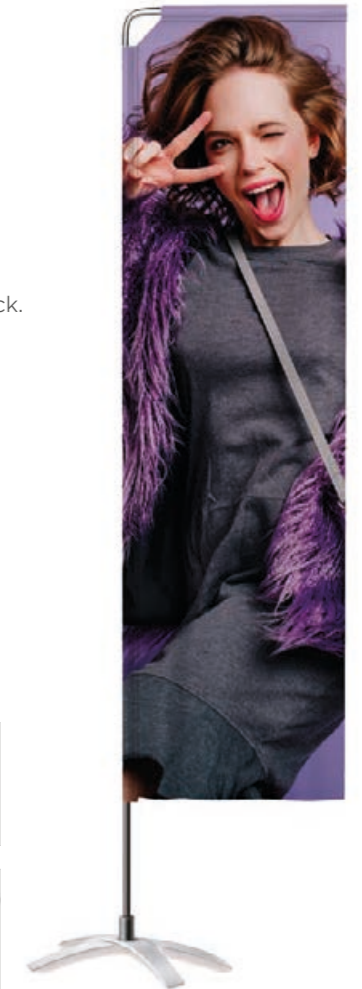

TWISTER SHARK FIN

M	TWS000320	1,60 kg	320 cm
L	TWS000430	1,70 kg	430 cm
XL	TWS000540	1,95 kg	540 cm

Zestaw zawiera: system Twister i torbę.

Rekomendowana technologia druku:



Tkanina do flag
Druk sublimacyjny

Ø 16,5 mm

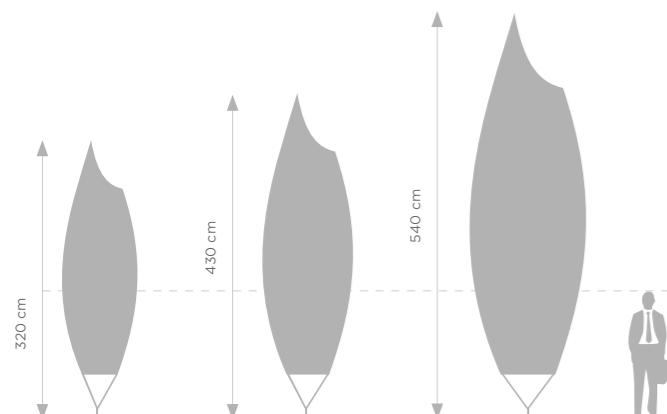

AVENUE

- Świetnie sprawdzi się na parkingach centrów handlowych, salonach samochodowych, alejach i deptakach miejskich. Zestaw zawiera: stalową bazę, górną i dolną belkę w kolorze białym, gumowe podkładki i opaski.

- Great for parking in shopping centers, car dealerships, alleys and city promenades. This set includes: upper and lower double pole, clamps, rubber pads, zips to protect flag/banner.

Rekomendowana technologia druku:



Tkanina do flag
Druk sublimacyjny



Baner powlekany
Solvent, UV, Latex

Ø 16,5 mm

Pojedynczy	66 cm	5907451663523
Podwójny	66 cm	5907451663530
Pojedynczy	80 cm	5907451667705
Podwójny	80 cm	5907451667712



PODSTAWY DO FLAG

PŁYTA

- kwadratowa płyta wykonana z ciężkiego żeliwa
- idealna baza i stabilizacja dla każdej flagi
- baza montowana do podłoża za pomocą szpilek
- wydrążona rączka ułatwia przenoszenie

- square plate made of heavy cast iron
- perfect base and stabilization for every flag
- base mounted to the ground using pins
- hollow handle makes it easy to carry



Waga	Kod kreskowy	Wymiary
4 kg	5907451661765	30x30 cm
6 kg	5907451661772	35x35 cm
8 kg	5907451661789	39x39 cm
12 kg	5907451661796	48x48 cm

Pin Ø 16,5 mm

PŁYTA Z GUMOWYMI NÓŻKAMI

- kwadratowa płyta wykonana z ciężkiego żeliwa
- idealna baza i stabilizacja dla każdej flagi
- wydrążona rączka ułatwia przenoszenie
- dzięki gumowym nóżkom płyta sprawdzi się wewnątrz budynków i na chodnikach
- płyta nie ślizga się i jest stabilna

- square plate made of heavy cast iron
- perfect base and stabilization for every flag
- hollow handle makes it easy to carry
- thanks to the rubber feet, it is ideal for use in buildings and on sidewalks
- with rubber feet, the plate does not slip and is stays stable



Waga	Kod kreskowy	Wymiary
4 kg	590745166176N	30x30 cm
6 kg	590745166177N	35x35 cm
8 kg	590745166178N	39x39 cm
12 kg	590745166179N	48x48 cm

Pin Ø 16,5 mm

ROTATOR

- ułatwia obracanie się flagi
- pasuje do wszystkich masztów

- makes it easy to rotate the flag
- fits all types of poles.



Pin Ø 16,5 mm



KRZYŻAK PŁASKI

- do użytkowania na podłożu płaskim i miękkim
- może być przytwierdzona do podłoża za pomocą szpilek
- może być dodatkowo obciążona sakwą wodną

- for use on flat and soft grounds
- can be attached to the ground with pins
- can be additionally loaded with a water bag



Kod kreskowy	Waga	Wymiary	Pin
5907451661857	2,3 kg	60x53 cm	Pin Ø 16,5 mm

KRZYŻAK RURKI

- elegancka podstawa przeznaczona głównie do wnętrz
- może być dodatkowo obciążona sakwą wodną

- elegant base designed mainly for indoor interiors
- can be additionally loaded with a water bag

KRZYŻAK RURKI SZARY



Kod kreskowy	Waga	Wymiary	Pin
5907451661864	1,4 kg	82x70 cm	Pin Ø 16,5 mm

KRZYŻAK RURKI CZARNY



Kod kreskowy	Waga	Wymiary	Pin
5907451669044	1,4 kg	82x70 cm	Pin Ø 16,5 mm

SAKWA WODNA

- dodatkowe obciążenie podstaw
- po napełnieniu wodą osiąga wagę nawet 10 kg
- sprawdza się w szczególności w przypadku wysokich masztów

- additional load
- after filled with water, it reaches a weight of up to 10 kg
- particularly suitable for high poles.



Kod kreskowy	Waga	Wymiary
5907451661871	0,5 kg	Ø 50 cm

Ø 50 mm



PODSTAWY DO FLAG

KONTENER WODNY

- bestseller
- wykonany z grubego plastiku z otworem zaciskowym na maszt
- po napełnieniu wodą może ważyć nawet do 20 kg
- bestseller
- made of thick plastic with a terminal hole for the mast
- after filled with water, it can weigh up to 20 kg



5907451663189 | 0,40 kg

AUTOBAZA

- metalowa podstawa przeznaczona dla salonów i komisów samochodowych
- jest to baza najazdowa, pod koło samochodowe
- opcjonalnie można zastosować rotator
- metal base designed for salons and car stores
- mounted under the car wheel
- optionally a rotator can be used



5907451661925 | 1,6 kg

Pin Ø 16,5 mm

BAGNET

- bestseller
- przeznaczony do mocowania masztów do miękkiego podłoża
- wykonany ze stali nierdzewnej
- wyposażony w rotator
- bestseller
- designed for fixing poles to soft grounds
- made of stainless steel
- equipped with a rotator



5907451661888 | 0,95 kg

Rotator Ø 16,5 mm

BAGNET PODWÓJNY

- udoskonalona wersja bagnetu
- podstawa posiada dodatkowy wbijak, który zapobiega obracaniu się bagnetu i jego destabilizacji
- improved version of the Bayonet
- this base has an additional impactor that prevents the Bayonet from rotating and destabilizing



5907451661895 | 1,25 kg

Rotator Ø 16,5 mm

DRYL

- sprawdzi się do mocowania masztów do powierzchni trawiastych i piaskowych
- posiada praktyczne, rozkładane rączki, które pomogą przykręcić podstawę do podłoża
- wykonany z tworzywa sztucznego
- posiada rotator
- perfect for fastening poles to grass and sand
- it has practical, folding handles that help screw the base to the ground
- made of plastic, includes a rotator



5907451661918 | 0,7 kg

Rotator Ø 16,5 mm

ROTATORY

ROTATOR 90°

- zintegrowany z żeliwną płytką
 - możliwość przymocowania podstawy do twardego podłoża
 - zestaw nie zawiera kołków i śrub mocujących
- integrated with a cast iron plate
 - ability to attach the base to a hard surface
 - set does not include dowels and fastening screws



5907451661932



0,80 kg

ROTATOR 45°

- służy do mocowania masztów do ściany
 - zestaw nie zawiera kołków i śrub mocujących
- used for attaching the poles to the wall
 - the set does not include dowels and fastening screws



5907451661949



0,80 kg

ROTATOR

- wykonany ze stali nierdzewnej
 - świetne zastępstwo do standardowych trzpieni w takich podstawach jak: płyty, krzyżak płaski, auto baza
 - pozwala na swobodne obracanie się masztu zgodnie z kierunkiem wiatru
- made of stainless steel
 - a great replacement for standard mandrels used in such bases as: plate, flat cross, auto base
 - allows free rotation of the mast in accordance with the direction of the wind



5907451661840



0,45 kg



STELAŻE DO NAMIOTÓW

STELAŻE DO NAMIOTÓW



- stelaże namiotowe wykonane z dwóch rodzajów materiałów: stali lub aluminium
 - dostępnych kilka rozmiarów
 - Everest - lżejsza konstrukcja, idealna do częstej zmiany lokalizacji
 - Blanc - ciężka, trwała konstrukcja, malowana na kolor biały
 - profil sześciokątny - trwalszy od prostokątnych
- Zestaw zawiera: stelaż namiotu, akcesoria, walizkę na kółkach.

BLANC (stalowy) 2,5x2,5	5907451661697	23 kg
BLANC (stalowy) 3x3	5907451661703	25 kg
BLANC (stalowy) 3x4,5	5907451661710	32 kg
BLANC (stalowy) 3x6	5907451661727	44 kg
EVEREST (aluminium) 3x3	5907451661734	17 kg
EVEREST (aluminium) 3x4,5	5907451661741	21 kg
EVEREST (aluminium) 3x6	5907451661758	32 kg

Warianty montażu wydruku:

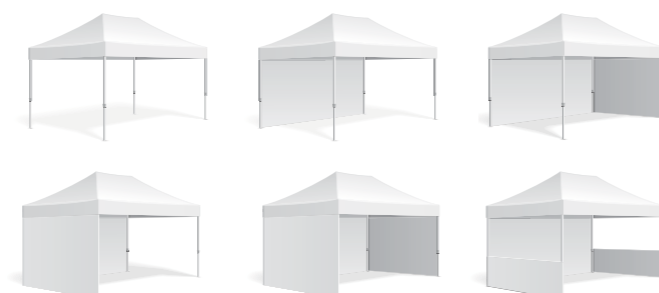

Rekomendowana technologia druku:



DACHY DO NAMIOTÓW

- wodoodporny
- trwałe kolory (odporne na promieniowanie UV)
- odporny na rozdieranie (poliester 250-270 g)

- waterproof
- durable colours (resistant to UV radiation)
- resistant to tearing (polyester 250-270 g)



3x3 biały	5907451666272	3,9 kg
3x3 niebieski	5907451666289	3,9 kg
3x3 czarny	5907451666302	3,9 kg
3x3 czerwony	5907451666296	3,9 kg
3x4,5 biały	5907451666760	5 kg
3x4,5 niebieski	5907451666746	5 kg
3x4,5 czarny	5907451666777	5 kg
3x4,5 czerwony	5907451666753	5 kg
3x6 biały	5907451666715	8 kg
3x6 niebieski	5907451666739	8 kg
3x6 czarny	5907451666708	8 kg
3x6 czerwony	5907451666722	8 kg

AKCESORIA

PODKOWA
(żeliwna)



5907451661963	5 kg

KONTENER
WODNY
(plastikowy)



5907451669990	1 kg + 14 l

SAKWA NA PIASEK
POJEDYŃCZA



5907451663332	0,1 kg + 12 kg

SAKWA NA PIASEK
PODWÓJNA



5907451661987	0,3 kg + 18 kg

BAZA
FLAGOWA



5907451661956	1 kg

HALFBAR
(alumiowy)



3 m	5907451661994	1,2 kg
4,5 m	5907451662007	1,6 kg



MEBLE EVENTOWE

STOŁY

- solidna konstrukcja (polietylen + stal)
- idealne na eventy plenerowe
- antypoślizgowe nakładki na nóżki
- składane
- specjalna rączka ułatwia przenoszenie (122, 180x75)

- solid construction (polyethylene + steel)
- perfect for outdoor event
- non-slips pads on legs
- foldable
- special handle ensures easy transport (122, 180x75)

STÓŁ KOKTAJLOWY 80

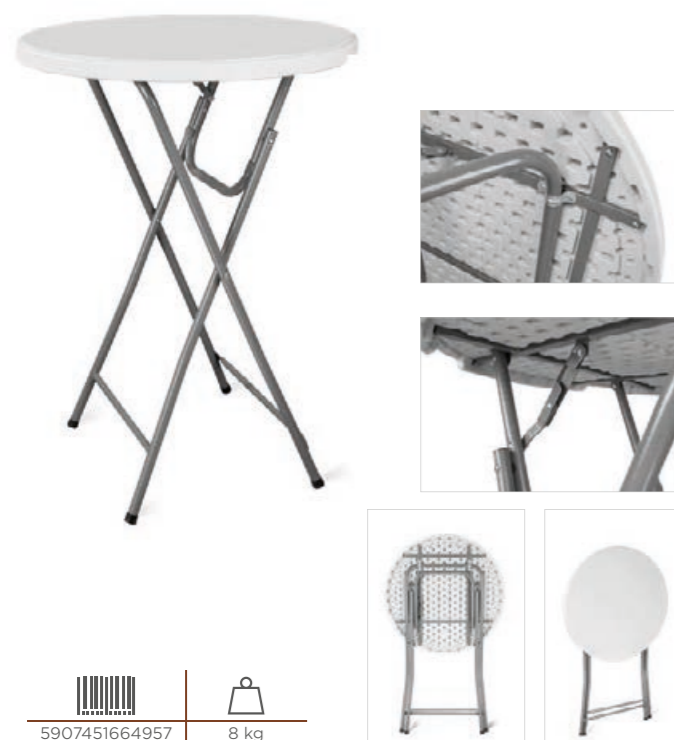

STÓŁ 180x75



STÓŁ OKRĄGŁY 122



TOPPER DO STOŁU 180x75

- prosty montaż
- dodatkowa powierzchnia reklamowa
- header montowany do prostokątnych stołów
- simple assembly
- great, original advertising area
- header mounted to rectangular tables

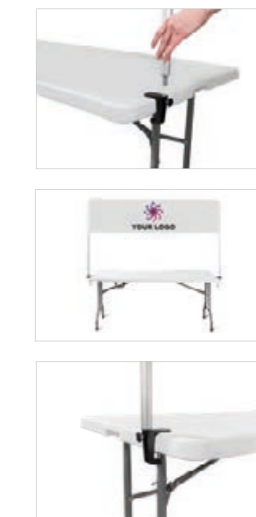

OBRUSY

- elastyczne
- wykonane z polietylenu z wysoką zawartością elastanu
- nadają się do prania, nie wymagają prasowania

- flexible tablecloth
- made of polyester and elastine
- washable, no need to be ironed

OBRUS DO STOŁU 80



OBRUS DO STOŁU 122



OBRUS DO STOŁU 180



WYCHODZIMY
NAPRZECIW
OCZEKIWIANIOM

**PRO
-MEDIA-
PLUS**

Szubińska 32, 60-114 Poznań, Polska

+48 61 307 60 62

www.promediaplus.com

Katalog z logo Twojej firmy

Pobierz katalog produktów ze strony www.promediaplus.com, umieść na nim swoje logo, wydrukuj i wykorzystuj jako świetne narzędzie sprzedażowe.